

20  
26  
THE  
CATA  
LOG

**the.artceram**

**the.**artceram

«TUTTE LE GRANDI BAND  
DEGLI ANNI '60  
INIZIANO COL "THE"»

«ALL THE GOOD  
60'S BANDS STARTED  
WITH A "THE"»

(THE COMMITMENTS, RODDY DOYLE, 1987)

## THE.ARTCERAM

UNA STORIA DI  
INNOVAZIONE  
P.6

THE.VILLAGE  
P.8

THE.AWARDS  
P.34

THE.TIMELINE  
P.36

## PRODUCT DNA

THE.COLOR LAB  
P.40

THE.SANIGLAZE  
P.56

MAGICLIGHT  
P.66

THE.RIMLESS  
P.78

THE.REEL  
P.84

## FURNITURE

BROOKLYN  
P.96

OPERA  
P.106

MONO  
P.116

RELAX  
P.126

CHURCH  
P.148

## SANITARYWARE

SOLIDA  
P.162

SETA  
P.180

A16  
P.200

VITA  
P.222

ATELIER  
P.242

FILE 2.0  
P.266

MONET  
P.284

HYPE  
P.306

CIVITAS  
P.322

HERMITAGE  
P.350

TEN  
P.376

## URINALS

BABILA  
P.398

LA FONTANA 2.0  
P.404

## WASHBASINS

JOLIE  
P.412

BROOKLYN  
P.424

WON  
P.442

WHISKY  
P.458

COGNAC &  
COGNAC QUADRO  
P.468

RODOLFO  
P.494

SCALINO  
P.508

BRERA  
P.522

FUORI SCALA  
P.538

ROMBO &  
MILLERIGHE  
P.550

ATELIER  
P.564

GHOST  
P.574

LA CIOTOLA  
P.584

LAVAMANI  
P.594

SOTTOPIANO  
P.606

## MIRRORS

LORD  
P.612

MILANO  
P.622

LOOK  
P.632

ARCHI  
P.640

## ACCESSORIES

PASSEPARTOUT  
P.648

BOLD  
P.660

## SHOWER TRAYS

AQUANIT  
P.670

LAPIS  
P.682

## BATHTUBS

PETITE  
P.696

HOOP  
P.704

HERMITAGE  
P.712

## SPARE PARTS

P.718

# INDEX

# THE. ART CERAM

ESTRO  
E FILOSOFIA  
DELL'AZIENDA

# Una storia di innovazione

Imprenditorialità Made in Italy, responsabilità sociale, attenzione ai dettagli e cura delle relazioni sono i valori strategici che Artceram pone al centro della produzione per la sua crescita. Con un occhio sempre attento alla sostenibilità, l'azienda propone prodotti che uniscono bellezza, tecnologia, design ed artigianalità, per comunicare qualità e tendenza.



Business mentality based on a "Made in Italy" concept, social responsibility, care for details and respect for relationships are the fundamental values of Artceram's production strategy and growth policy. Always focused on sustainability, our company products are characterized by beauty, technology, design and craftsmanship that convey quality and trendy ideas.



# THE



# VILLAGE

In un contesto sperimentale, si colloca The.Artceram Village, che racconta il “mondo” Artceram promuovendo arte e territorio, in modo creativo e rigoroso, a tratti perfino dissacratorio. Artceram crede fortemente nella responsabilità sociale nei confronti del territorio e della comunità, per una relazione diretta ed empatica con gli interlocutori del suo mondo. The.Artceram Village è il contemporaneo mecenatismo umanistico e internazionale! Una vera e propria “casa” per coloro che si riconoscono nei valori aziendali, dove si organizzano e promuovono attività ed eventi culturali sempre strettamente correlati al brand.



The.Artceram Village is placed in an experimental context and depicts the “Artceram’s world” by creatively and rigorously promoting artistry and territory even in a desecrating way. Artceram strongly believes in social responsibility towards the territory and communities and creates direct and empathic relationships with people in its world. The.Artceram Village represents a kind of contemporary humanistic and international patronage! A real “home” for those who identify themselves with the company values and where activities and cultural events – strictly interrelated with the branding – are promoted.

Un'architettura industriale reinterpretata, un "non luogo" come mutevole contenitore dalle diverse facce e geometrie, che viene reinterpretato per accogliere al suo interno il nuovo showroom aziendale. Uno spazio che mantiene il carattere originario

dell'edificio e lo trasforma in un ambiente dinamico, pensato per raccontare il mondo Artceram. Il progetto introduce un completo rinnovamento della distribuzione degli spazi e degli allestimenti, in continuità con l'immagine e il linguaggio progettuale dell'azienda.



## UNBOXING CUBES EXHIBITION

An industrial architecture reimagined: a "non-place", a mutable container with different faces and geometries, reinterpreted to host the new company showroom. A space that preserves the original character of the building while transforming it into a dynamic environment, designed to tell the story of the Artceram world. The project introduces a complete renewal of the spatial layout and exhibition design, in continuity with the company's image and design language.



Freestanding platforms placed at the heart of the industrial architecture guide the path between exhibition and workshop, shaping a flexible environment in continuous dialogue with the space. A place designed for meeting and sharing, where the presence of an indoor olive tree introduces a natural element within the industrial landscape.



Platform freestanding adagiati nel cuore dell'architettura industriale accompagnano il percorso tra esposizione e workshop, costruendo un ambiente flessibile e in continuo dialogo con lo spazio. Un luogo pensato per l'incontro e la condivisione, dove anche la presenza di un ulivo indoor introduce un segno naturale all'interno del paesaggio industriale.





## WALL OF FAME

The journey leads to the “Wall of Fame”, an area dedicated to the history of The.Artceram’s most iconic products and to the awards the company has received over the years. In front of this celebratory wall, three large tables on wheels define the work area: mobile elements that allow the space to be easily reconfigured.

Il percorso conduce alla “Wall of Fame”, angolo dedicato alla storia dei pezzi aziendali più iconici e ai riconoscimenti ottenuti in questi anni di The.Artceram! Di fronte alla parete celebrativa tre grandi tavoli su ruote definiscono l’area work: elementi mobili che permettono di riconfigurare lo spazio.



La Chiesa è un unicum, un suggestivo spazio di oltre 550mq ricavato da un'antica chiesa di Frati Cappuccini del 1577. Luogo magico e suggestivo che amiamo utilizzare come una "tela bianca" nel quale inserire installazioni museali.



## THE. CHURCH

The Church is unique of its kind, a fascinating space of more than 550sqm inside an old church dating back to 1577 that belonged to Capuchin Friars. It's a magic, charming space that is internally used as a "blank canvas" for museum installations.

La grande navata centrale accoglie il visitatore in uno spazio ampio e solenne, dove la verticalità dell'architettura e la luce naturale creano un'atmosfera suggestiva.

Sospesi nello spazio, gli ombrelli diventano un segno grafico inatteso: un'installazione leggera che anima la navata e contribuisce al comfort acustico.



The large central nave welcomes visitors into a spacious and solemn setting, where the verticality of the architecture and natural light create a striking atmosphere. Suspended in space, the umbrellas become an unexpected graphic element: a light installation that animates the nave and contributes to the acoustic comfort of the environment.



Beside the main nave, more intimate spaces unfold: environments where light, architecture, and the exhibition design interact, amplifying the scenographic character of the space. The lateral chapels thus become two “architectural wings” capable of surprising visitors and making the experience even more iconic and memorable.

Accanto alla navata principale si aprono spazi più raccolti: ambienti intimi dove luce, architettura e progetto espositivo dialogano amplificandone il carattere scenografico. Le cappelle laterali diventano così due “quinte architettoniche” capaci di sorprendere il visitatore e di rendere l’esperienza ancora più iconica e memorabile.



Gli allestimenti fieristici di Artceram al Cersaie di Bologna, utilizzati nel corso degli anni, diventano materia viva: elementi già impiegati vengono reinterpretati e trasformati in nuove configurazioni spaziali che prendono vita all'interno della nostra chiesa. Un percorso di continuità progettuale che esprime una visione di design circolare, consapevole e responsabile.



Artceram's exhibition setups for Cersaie in Bologna, used over the years, become living matter: elements previously employed are reinterpreted and transformed into new spatial configurations that come to life within our church. A path of design continuity that expresses a circular, conscious, and responsible vision of design.



# THE GARDEN



Il bianco immacolato della facciata della chiesa si affaccia sul verde del prato, dove elementi iconici black&white e silhouettes femminili in metallo si ergono come totem metropolitani contribuendo a creare l'atmosfera accogliente di questa fabbrica dal volto umano.

The immaculate whiteness of the church facade overlooks the greenness of the grass where iconic elements in black&white and the women silhouettes soar like city totems and contribute to the warming atmosphere of this company with a human touch.



Uno spazio conviviale che si apre al verde della campagna, un container che “racchiude” tutti i valori aziendali, per promuovere il territorio in modo creativo e dissacratorio. Accanto allo stabilimento un terreno collinare di 10 ettari con circa 230 ulivi ed un’area frantoio di 300 mq, dove si produce un ottimo olio made in The.Artceram!

## THE.OLIVE GROVE

A convivial space surrounded by greenery, a 40’ box that “contains” the company core values to promote in a creative and irreverent way the territory. A hilly area of about 25 acres, 230 olive trees and a 300sqm oil mill space where an excellent made in The.Artceram oil is produced!

# THE.LOFT

The.Loft - a sign of wealth restoration - is a roomy and bright office similar to a greenhouse set in the garden. Once a tyres shop, now it's been changed into a functional and pleasant environment that lights up and shines as a jewel when the night comes.

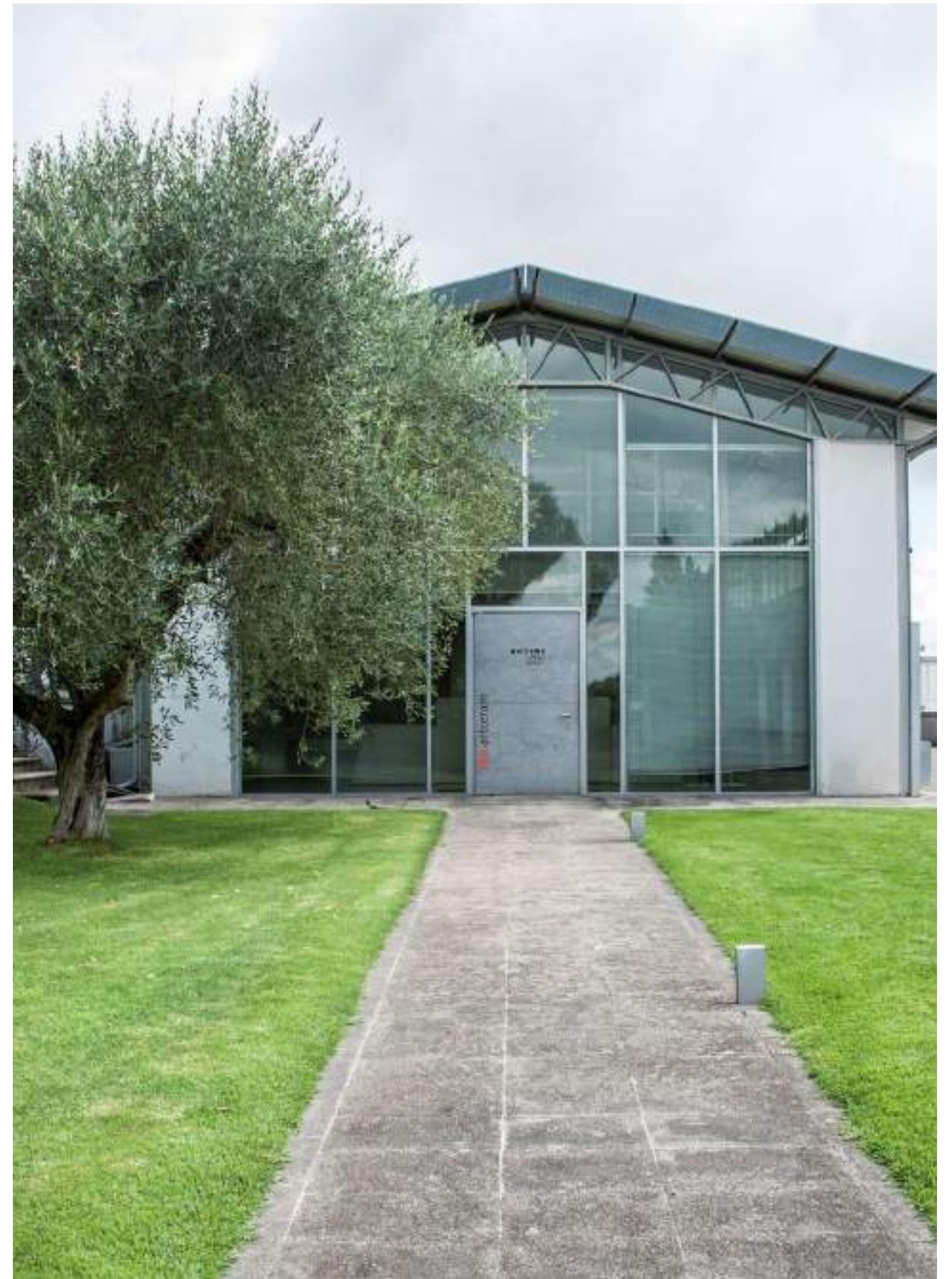

Nel segno del recupero di ogni ricchezza presente, The.Loft, uno spazioso e luminoso ufficio, quasi una serra incastonata nel giardino, frutto della trasformazione di una ex officina

di pneumatici, diventata ambiente gradevole e funzionale, che di notte si illumina, brillando come un vero e proprio gioiello sul giardino.









# THE.FACTORY





The final goal and the choice that stems from it to enhance the production in Italy are not only linked to cost factors. We have realized that it is essential to control every step of the manufacturing process of our sanitaryware in order to ensure the quality our The.Artceram brand has been granting customers for decades.

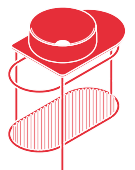

L'obiettivo e la conseguente scelta di potenziare la produzione in Italia non sono dovuti a soli fattori di costo. Abbiamo compreso come sia indispensabile controllare il

processo produttivo dei nostri elementi d'arredo bagno affinché garantiscano la qualità di cui il brand The.Artceram è ormai da decenni portavoce.

LA FONTANA		I.DOT ITALIAN DESIGN ON TOUR
BLEND		reddot design award winner 2009
JAZZ		ADI ASSOCIAZIONE PER IL DISEGNO INDUSTRIALE
BACK		reddot design award winner 2011
IL CAVALLETTO		DESIGN INDEX ADI 2013
TT		reddot design award winner 2016
THE ONE		DESIGN AWARD 2020 powered by ISH DESIGN PLUS GERMAN DESIGN AWARD SPECIAL 2019 ADI ASSOCIAZIONE PER IL DISEGNO INDUSTRIALE

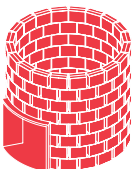
CARTESIO		archiproducts DESIGN AWARDS WINNER 2018 DESIGN PLUS powered by ISH
FLAIR		archiproducts DESIGN AWARDS WINNER 2020 AWARD ELLE BEST OF THE YEAR
JOLIE		archiproducts DESIGN AWARDS WINNER 2021
CHIC		archiproducts DESIGN AWARDS 2022 WINNER
BRERA		archiproducts AWARDS WINNER CASUM AWARDS BIG SEE Product Design Award 2024 Winner
BROOKLIN		archiproducts AWARDS WINNER ADI DESIGN INDEX Selezione Compasso d'Oro Premio Eccellenze Design 2025 Lazio
DARK MATTER BOOTH		ADI BOOTH DESIGN AWARD 2024 ADI DESIGN INDEX Selezione Compasso d'Oro

# The.Awards

From 2006, the strategic focus on design led to international awards for innovation, research as well as fresh, smart ideas in our products.

Dal 2006 ad oggi, la scelta strategica di puntare sul design ha portato significativi riconoscimenti internazionali che hanno premiato l'innovazione, la ricerca e la freschezza delle proposte.



Fattore design

# The Timeline

 prodotto premiato  
awarded product

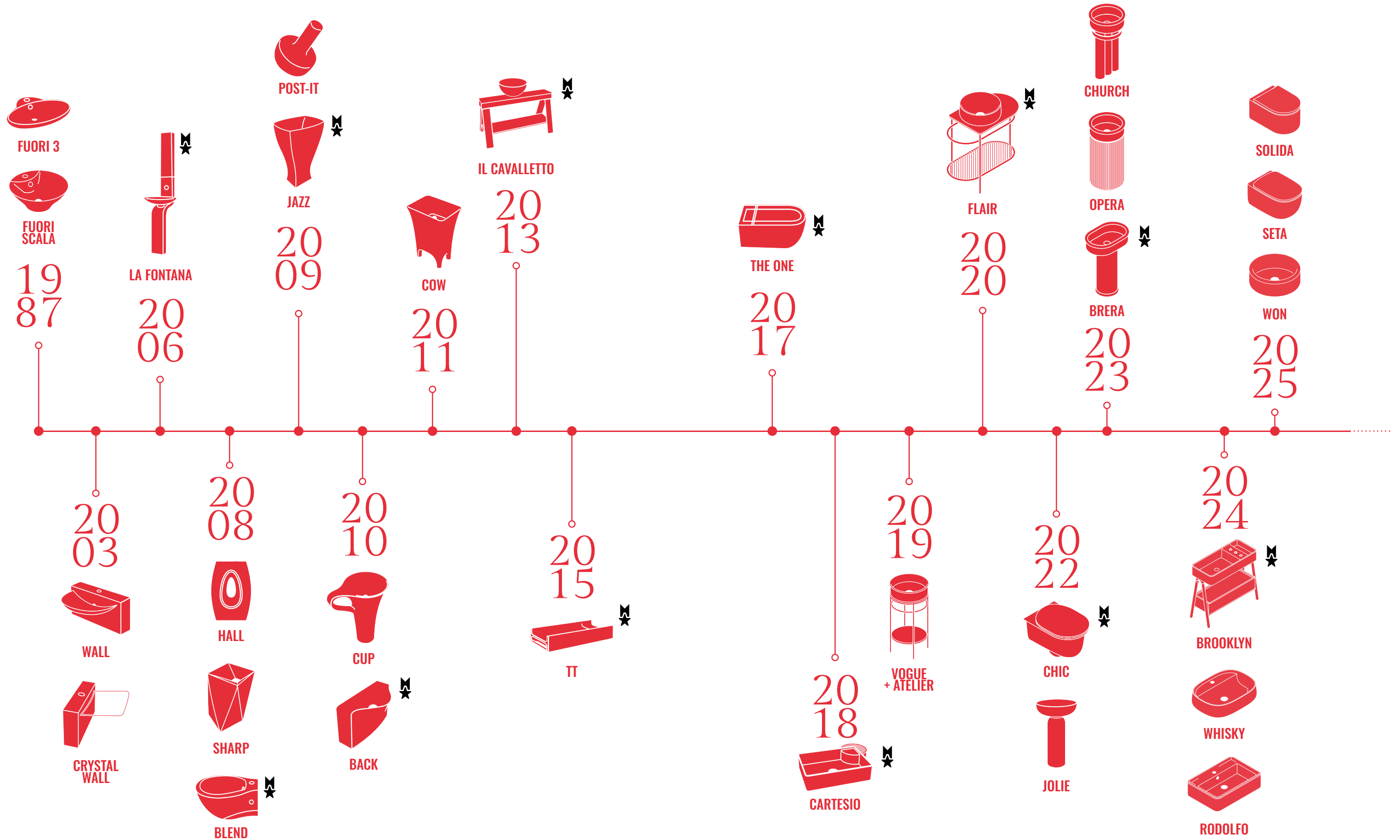

# PRO DUCT DNA

LE PRINCIPALI CARATTERISTICHE  
DEI PRODOTTI THE.ARTCERAM

THE.COLOR LAB (P.40)

THE.SANIGLAZE (P.56)

MAGICLIGHT (P.66)

THE.RIMLESS (P.78)

THE.REEL (P.84)

# THE. COLOR LAB



Scopri online  
Discover them online

I COLORI  
THE.ARTCERAM

CLASSIC (P.42)

MATT (P.46)

GLOSSY (P.52)

La bellezza essenziale della ceramica declinata in tonalità senza tempo, veri evergreen che non passano mai di moda! La linea Classic interpreta così l'essenza stessa della ceramica attraverso tre finiture iconiche: un Bianco Lucido brillante, un Bianco Opaco dal carattere

morbido e vellutato, e un Nero Matt profondo e deciso. Tonalità che dialogano con qualsiasi stile di bagno e permettono di creare ambienti equilibrati, puliti ed eleganti. Una base cromatica neutra, pensata per valorizzare ogni progetto architettonico.

# BIANCO LUCIDO BIANCO MATT NERO MATT



# CLASSIC



The essential beauty of ceramics expressed through timeless shades, true evergreen tones that never go out of style! The Classic line embodies the very essence of ceramic through three iconic finishes: a brilliant Glossy White, a soft and velvety Matt White, and a deep, refined Matt Black. Tones that complement any bathroom style, creating balanced, clean and elegant spaces. A neutral chromatic base designed to enhance every architectural project.



**BIANCO LUCIDO  
GLOSSY WHITE**

cod. 01

La finitura ceramica per eccellenza, simbolo della tradizione più autentica. Brillante e puro, riflette la luce e dona luminosità allo spazio, per un effetto raffinato e pulito.

*The quintessential ceramic finish, a true symbol of authentic tradition. Bright and pure, it reflects light and brightens the space, creating an refined and clean effect.*



**BIANCO MATT  
MATT WHITE**

cod. 05

Un sussurro sulla superficie, discreto e sofisticato. Avvolge le forme ceramiche con delicatezza, valorizzando volumi e dettagli con un'eleganza unica senza ostentazione.

*A whisper on the surface, discreet and sophisticated. It gently embraces the ceramic forms, enhancing volumes and details with a unique, understated elegance.*



**NERO MATT  
MATT BLACK**

cod. 17

L'intensità della notte in un'unica finitura. Profonda, grafica, decisa: aggiunge carattere e contemporaneità, scolpendo lo spazio con stile e armonia moderna.

*The intensity of the night in a single finish. Deep, graphic, and bold: it adds character and contemporary flair, sculpting the space with modern style and harmony.*



Cinque colori opachi che esprimono l'anima contemporanea del bagno: sfumature autentiche e raffinate ispirate alla natura. Una palette equilibrata che spazia dai verdi intensi ai blu polverosi, fino ai toni caldi della terra... Tutti in finitura opaca e setosa, avvolgono

la ceramica in un'estetica morbida e delicata, trasformandola in un segno di stile quotidiano. Colori che non vogliono imporsi, ma accompagnano il progetto d'interni con armonia e discrezione, creando connessioni visive equilibrate e atmosfere rilassanti.



# MATT

**SABBIA  
GHIAIA  
MARRONE MATERA  
GRIGIO OLIVA  
BLU AVIO**



Five matt colors that express the contemporary soul of the bathroom: authentic, refined shades inspired by nature. A balanced palette ranging from deep greens to dusty blues, to warm earthy tones... All in a matt, silky finish, they envelop the ceramic in a soft and delicate aesthetic, transforming it into a mark of everyday style. Colors that do not seek to dominate, but accompany the interior design with harmony and subtlety, creating balanced visual connections and calming atmospheres.



**SABBIA  
SAND**

cod. 59

Soffice e avvolgente come la sabbia delle dune. Un tono che trasmette tranquillità, trasformando il bagno in uno spazio accogliente dove ogni dettaglio è in naturale armonia.

*Soft and enveloping like the sand of the dunes. A shade that conveys tranquility, transforming the bathroom into a welcoming space where every detail is in natural harmony.*



**GHIAIA  
GRAVEL**

cod. 60

Con un chiaro richiamo al pietrisco minerale, questo grigio leggero è raffinato e discreto: illumina gli ambienti senza imporsi, creando un effetto visivo equilibrato e sofisticato.

*With a clear reference to mineral gravel, this light gray is refined and understated: it brightens spaces without overwhelming them, creating a balanced and sophisticated visual effect.*



**MARRONE MATERA  
BROWN MATERA**

cod. 41

Ispirato alle terra di Matera, questo tono neutro dona solidità e calore naturale, conferendo agli spazi una personalità forte ma raffinata, capace di armonizzarsi con materiali diversi.

*Inspired by the soils of Matera, this neutral tone provides solidity and natural warmth, giving spaces a strong yet refined personality that harmonizes effortlessly with different materials.*



**GRIGIO OLIVA  
GREY OLIVE**

cod. 15

Un grigio caldo dal sottotono elegante e naturale, arricchito da una sottile sfumatura vegetale. Questa tonalità sofisticata e avvolgente porta equilibrio e sobrietà alla stanza da bagno.

*A warm gray with an elegant, natural undertone, enriched by a subtle vegetal hint. This sophisticated and enveloping shade brings balance and serenity to the bathroom.*



**BLU AVIO  
BLUE AVIO**

cod. 38

Si ispira ai cieli sereni dei pomeriggi d'estate questo blu intenso e vivace. Dona carattere e profondità allo spazio, creando un'atmosfera decisa che di certo non passa inosservata.

*Inspired by the clear skies of summer afternoons, this deep and vibrant blue brings character and depth to the space, creating a bold atmosphere that certainly doesn't go unnoticed.*

Artceram propone una palette di nuance superglossy, vibranti e contemporanee, pensate per valorizzare le superfici morbide e le linee essenziali dei prodotti in ceramica: Paprika, Curcuma, Edera e Zefiro. Tonalità capaci di trasformare ogni ambiente,

offrendo infinite possibilità di personalizzazione e stile. Questi colori si affiancano alle finiture esistenti, creando combinazioni eleganti e originali, disponibili su diverse collezioni per dare carattere e identità a ogni progetto.

# GLOSSY



**PAPRIKA  
CURCUMA  
EDERA  
ZEFIRO**

Artceram offers a palette of super-glossy, vibrant, and contemporary shades, designed to enhance the smooth surfaces and clean lines of its ceramic products: Paprika, Curcuma, Edera, and Zefiro. These tones have the power to transform any space, offering endless possibilities for personalization and style. They complement existing finishes, creating elegant and original combinations, and are available across multiple collections to bring character and identity to every project.



**CURCUMA  
TURMERIC**

cod. 67

Un giallo dorato, brillante e solare, che illumina e vivacizza il bagno. Questa tonalità audace valorizza le forme essenziali dei nostri prodotti, regalando spazi pieni di calore e originalità.

*A golden yellow, bright and sunny, that illuminates and enlivens the bathroom. This bold shade enhances the clean lines of our products, creating spaces full of warmth and originality.*



**PAPRIKA  
PAPRIKA**

cod. 68

Richiama il calore e la ricchezza delle spezie esotiche: un rosso caldo e intenso che dona un tocco avvolgente e sofisticato, trasformando le superfici in vere protagoniste dello spazio.

*It evokes the warmth and richness of exotic spices: a warm, intense red that adds an enveloping and sophisticated touch, transforming surfaces into true focal points of the space.*



**EDERA  
IVY**

cod. 69

Un verde profondo e rigoglioso che celebra freschezza e rinascita, ispirando sensazioni di equilibrio e serenità. Rende immediatamente distintivo e riconoscibile ogni progetto.

*A deep, lush green that celebrates freshness and renewal, evoking a sense of balance and serenity. It makes every project immediately distinctive and recognizable.*



**ZEFIRO  
ZEPHYR**

cod. 70

Intenso e deciso, questo blu è ricco e avvolgente. Come un soffio etereo, porta carattere e raffinatezza ai bagni più sofisticati e chic, trasformando gli spazi in boudoir intimi.

*Intense and bold, this blue is rich and enveloping. It brings character and refinement to the most sophisticated and chic bathrooms, transforming the spaces into intimate little boudoirs.*

# THE. SANI GLAZE



Scopri online  
Discover it online

SISTEMA COMBINATO DI PROTEZIONE  
ANTIBATTERICA + EASY-TO-CLEAN

COMBINED SYSTEM OF ANTIBACTERIAL  
PROTECTION + EASY-TO-CLEAN

# The.Saniglaze

Un nuovo sistema combinato di protezione antibatterica + easy-to-clean. The.Saniglaze è uno speciale trattamento, perfettamente integrato nella superficie della ceramica, che non è in alcun modo visibile e può essere applicato anche ai prodotti colorati. Lo smalto antibatterico arricchito con ioni di Argento, Titanio e Zinco, rende le superfici ancora più lisce e brillanti ed assicura un'azione antibatterica certificata ISO 22196. Ciò si traduce in una perfetta omogeneità della superficie offrendo una porosità ridotta al minimo e una resistenza maggiore alle macchie, allo sporco, agli agenti chimici aggressivi e al deterioramento della superficie.



## IGIENE PROFONDA

TOTAL HYGIENE

## MAGGIORE BRILLANTEZZA

A BRIGHTER SHEEN

## VELICITÀ DI PULIZIA

QUICK CLEANING

## RISPETTO PER L'AMBIENTE

RESPECT FOR THE ENVIRONMENT

## SUPERFICIE PIÙ LISCIA

SMOOTHER SURFACE

A new combined system of antibacterial protection + easy-to-clean. The.Saniglaze is a special treatment, perfectly integrated in the ceramic surface, totally invisible and also applicable to coloured items. The antibacterial glaze enriched with silver, titanium and zinc ions makes the surfaces even smoother, brilliant and ensure antibacterial action certified ISO 22196. This results in perfect homogeneity of surface, porosity reduced to a minimum, greater resistance to stains, dirt, aggressive chemicals and surface deterioration.

# EASY-TO-CLEAN & ANTIABACTERIAL PROPERTY

The ceramic surface treated with The.Saniglaze innovative process shows an increase in waterproof properties. By reducing the surface tension of water (instead of slipping off the surface in individual drops it runs off like a ultra-thin flow) dirt particles can be easily removed and make it harder for limestone to deposit. This results in a lower use of cleaning products, lower water consumption and lower environmental impact.



**SENZA SANIGLAZE / WITHOUT SANIGLAZE**

Gocce separate creano facilmente macchie di calcare  
*Separate droplets easily create limescale stains*



**CON SANIGLAZE / WITH SANIGLAZE**

Pellicola ultrasottile con difficile deposito di calcare  
*Ultra-thin film with difficult limescale buildup*



Il trattamento innovativo The.Saniglaze conferisce alla superficie ceramica proprietà antibatteriche e easy-to-clean.

Quando i batteri entrano in contatto con la superficie, il loro ciclo vitale si interrompe, garantendo un'efficacia antibatterica del 99,98% nel tempo (se si usano detersivi non abrasivi).

Il trattamento rende inoltre la superficie idrorepellente: l'acqua non si ferma in gocce, ma scorre come un velo sottile portando via lo sporco e riducendo i depositi di calcare. Il risultato è una superficie più pulita, che richiede meno acqua, meno prodotti e offre un minore impatto ambientale.

# THE.SANIGLAZE SYSTEM

Scopri qui di seguito tutti i prodotti The.Artceram dove lo speciale trattamento anticalcare ed antibatterico The.Saniglaze è disponibile – anche sui prodotti colorati. Un nuovo smalto addizionato che riduce al minimo la porosità superficiale, propria della ceramica, e che rende le superfici più levigate, brillanti, facilmente lavabili e durevoli nel tempo. Viene applicato ai prodotti durante il ciclo di produzione, prima della cottura ad alta temperatura, in questo modo gli ioni attivi rimangono “imprigionati” nel materiale stesso per un’azione igienizzante e permanente.

## WC E BIDET / WCS AND BIDETS

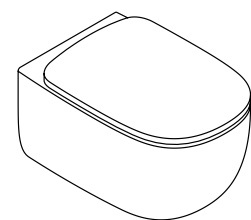

**SETA  
(SEV001)**

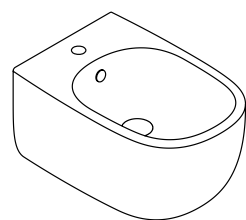

**SETA  
(SEB001)**

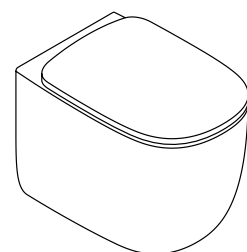

**SETA  
(SEV002)**

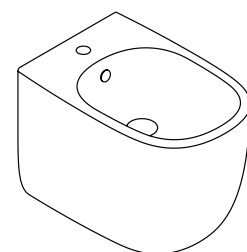

**SETA  
(SEB002)**

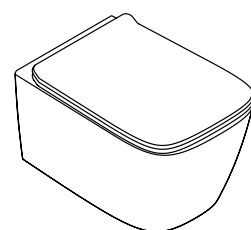

**A16  
(ASV006)**

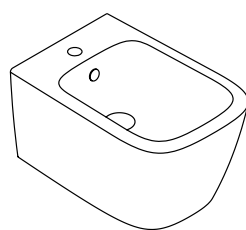

**A16  
(ASB004)**

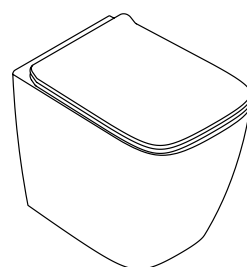

**A16  
(ASV007)**

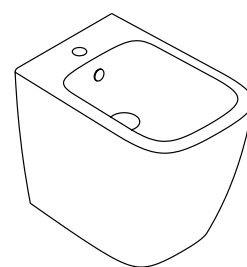

**A16  
(ASB005)**

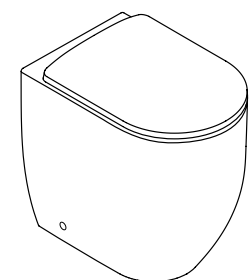

**MONET PLUS  
(MNV003)**

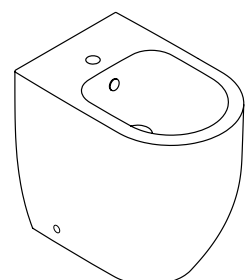

**MONET PLUS  
(MNB003)**

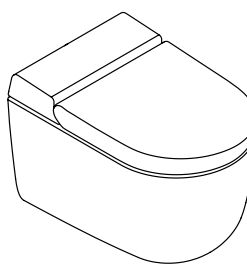

**HYPE  
(HYV001)**

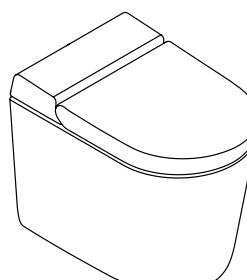

**HYPE  
(HYV002)**

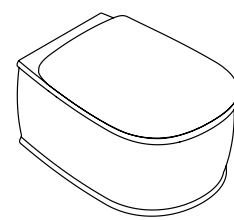

**ATELIER  
(ATV001)**

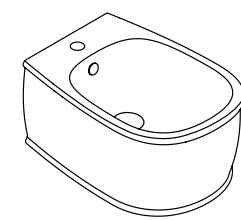

**ATELIER  
(ATB001)**

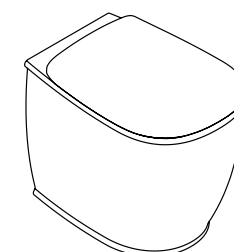

**ATELIER  
(ATV002)**

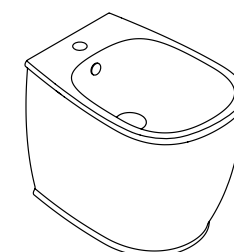

**ATELIER  
(ATB002)**

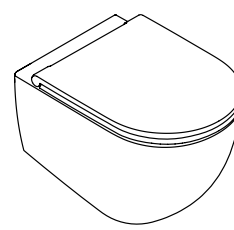

**VITA  
(VIV001)**

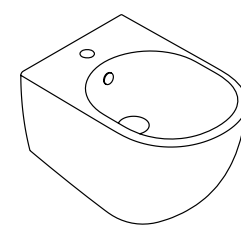

**VITA  
(VIB001)**

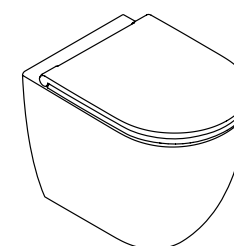

**VITA  
(VIV002)**

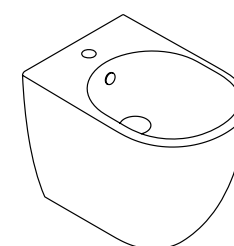

**VITA  
(VIB002)**

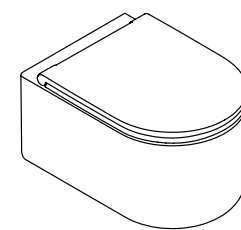

**SOLIDA  
(SOV001)**

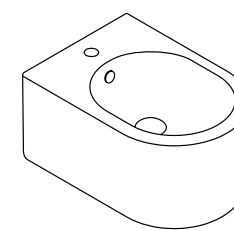

**SOLIDA  
(SOB001)**

*In the following section you can discover all The.Artceram products specially treated with The.Saniglaze anti-limescale and anti-bacterial process – available also on coloured items. A new enriched glaze which reduces to a minimum the surface porosity, inherent in ceramics, makes the surfaces smoother, more brilliant, easy-to-clean and long-lasting. The treatment is applied to products during the production cycle, before high-temperature firing, so that active ions are “captured” for a permanent and optimal sanitizing action.*

# THE.SANIGLAZE SYSTEM

## ORINATOI / URINALS

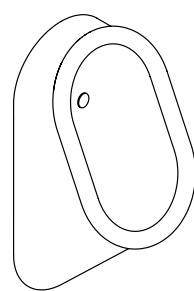

**BABILA**  
(BR001)

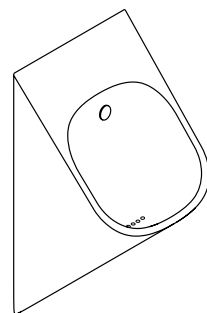

**LA FONTANA 2.0**  
(LF0002)

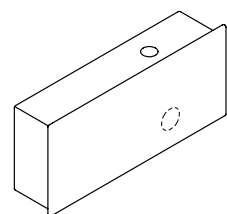

**PASSEPARTOUT**  
(OSL014, OSL015, OSL016, OSL017)

## LAVABI / WASHBASINS

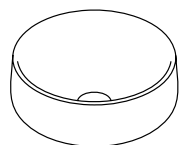

**COGNAC 42**  
(COL001)

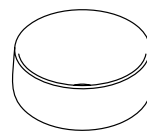

**COGNAC 35**  
(COL004)

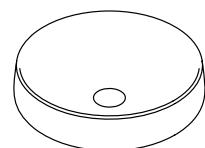

**COGNAC 48**  
(COL002)

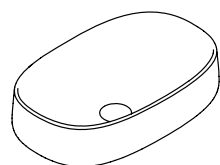

**COGNAC 55**  
(COL003)

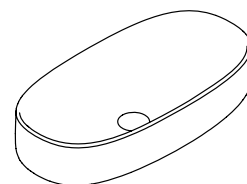

**COGNAC 68**  
(COL005)

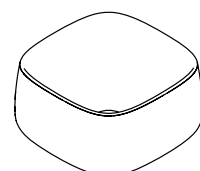

**COGNAC QUADRO 43**  
(COL006)

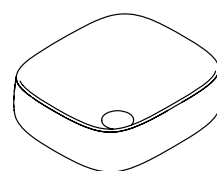

**COGNAC QUADRO 46**  
(COL007)

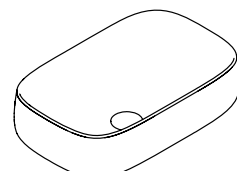

**COGNAC QUADRO 55**  
(COL008)

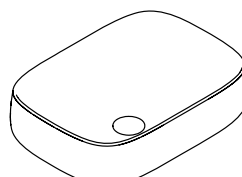

**COGNAC QUADRO 56**  
(COL009)

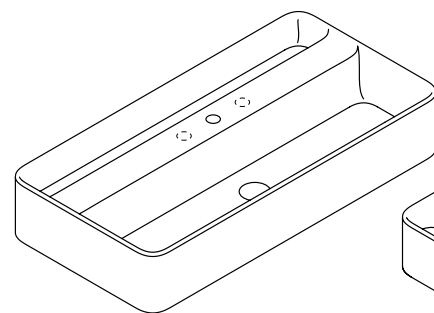

**BROOKLYN**  
(BNL001)

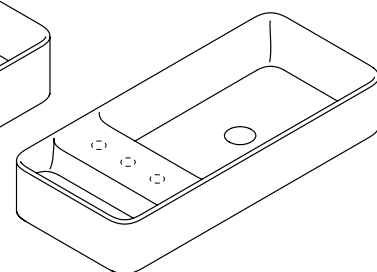

**BROOKLYN**  
(BNL002)

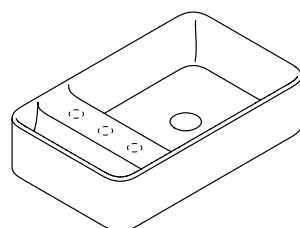

**BROOKLYN**  
(BNL003)

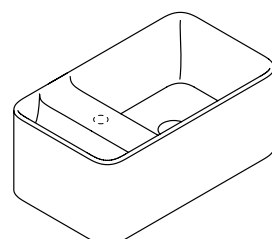

**BROOKLYN**  
(BNL004)

## ACCESSORI / ACCESSORIES

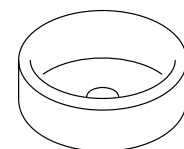

**WON**  
(WNL001)

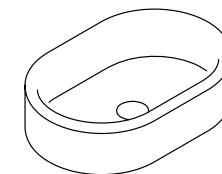

**WON**  
(WNL002)

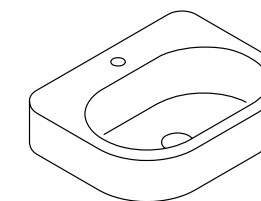

**WON**  
(WNL003)

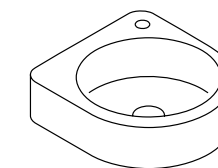

**WON**  
(WNL004)

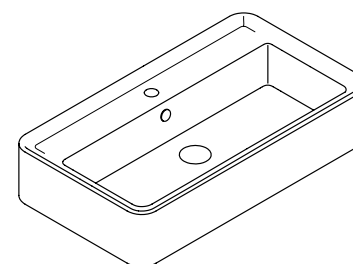

**RODOLFO**  
(ROL001)

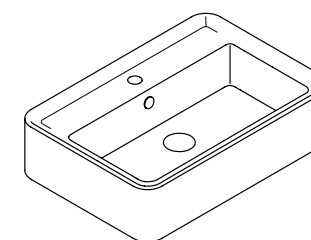

**RODOLFO**  
(ROL002)

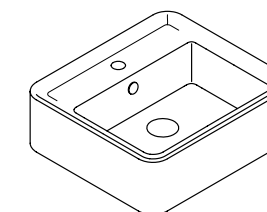

**RODOLFO**  
(ROL003)

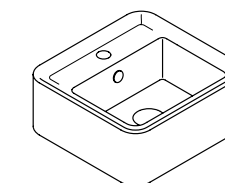

**RODOLFO**  
(ROL004)

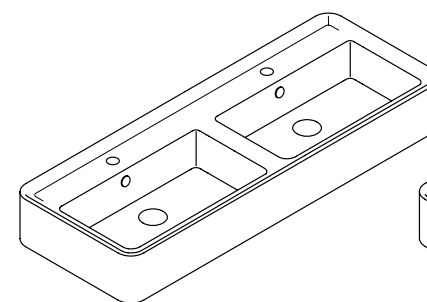

**RODOLFO**  
(ROL006)

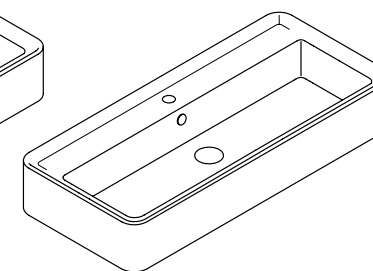

**RODOLFO**  
(ROL005)

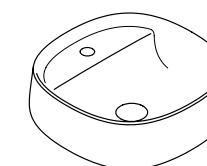

**WHISKY**  
(WHL001)

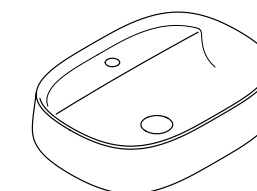

**WHISKY**  
(WHL002)

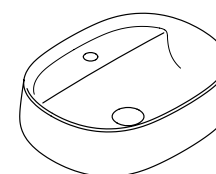

**WHISKY**  
(WHL003)

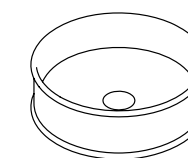

**ATELIER**  
(ATL001)

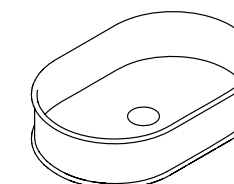

**ATELIER**  
(ATL002)

# MAGIC LIGHT



Scopri online  
Discover it online

DISPOSITIVO DI SANIFICAZIONE  
A RAGGI ULTRAVIOLETTI



# Magilight

Magilight è igiene totale a 360°. Un sistema innovativo di sanificazione a raggi ultravioletti che offre una protezione profonda, eliminando batteri e germi invisibili, e garantendo la massima pulizia all'interno della camera del WC. Un piccolo dispositivo che racchiude un mondo di funzionalità: il suo design intelligente si integra nel sedile del WC, e grazie a un sensore di movimento, il modulo superiore si illumina, creando anche una delicata luce ambientale. Con Magilight puoi trasformare ogni momento in un'opportunità di igiene impeccabile, proteggendo te stesso e la tua famiglia da batteri invisibili, in modo semplice, sicuro ed elegante.

Magilight offers total hygiene at 360°. An innovative ultraviolet sterilization system that provides deep protection, eliminating invisible bacteria and germs, ensuring maximum cleanliness inside the toilet bowl. A small device packed with functionality: its intelligent design integrates seamlessly into the toilet seat, and thanks to a motion sensor, the upper module lights up, also creating a soft ambient light. With Magilight, you can turn every moment into an opportunity for impeccable hygiene, protecting yourself and your family from invisible bacteria, in a simple, safe, and elegant way.

## IGIENE TOTALE A 360°

360° TOTAL HYGIENE

## STERILIZZAZIONE UVC

UVC STERILIZATION

## SICUREZZA INTELLIGENTE

INTELLIGENT SAFETY

## DESIGN INTEGRATO

INTEGRATED DESIGN



### STERILIZATION **MODE-ON**

Quando il sedile è chiuso, la modalità di sterilizzazione si attiva automaticamente dopo 10 secondi e passa in modalità sleep dopo 3 minuti di sterilizzazione. Durante il processo, viene emessa una luce blu insieme alle radiazioni UVC.

*When the seat is closed, the sterilization mode activates automatically after 10 seconds and enters sleep mode after 3 minutes of sterilization. During the process, a blue light is emitted along with the UVC radiation.*



### STERILIZATION **NOT ACTIVE**

In modalità sterilizzazione attiva, quando il coperchio viene aperto anche solo di 10°, la sterilizzazione si interrompe immediatamente. L'illuminazione rimane attiva per 10 secondi, per poi passare alla modalità sleep.

*In active sterilization mode, when the seat is opened by even just 10°, the sterilization stops immediately. The lighting remains on for 10 seconds, then switches to sleep mode.*

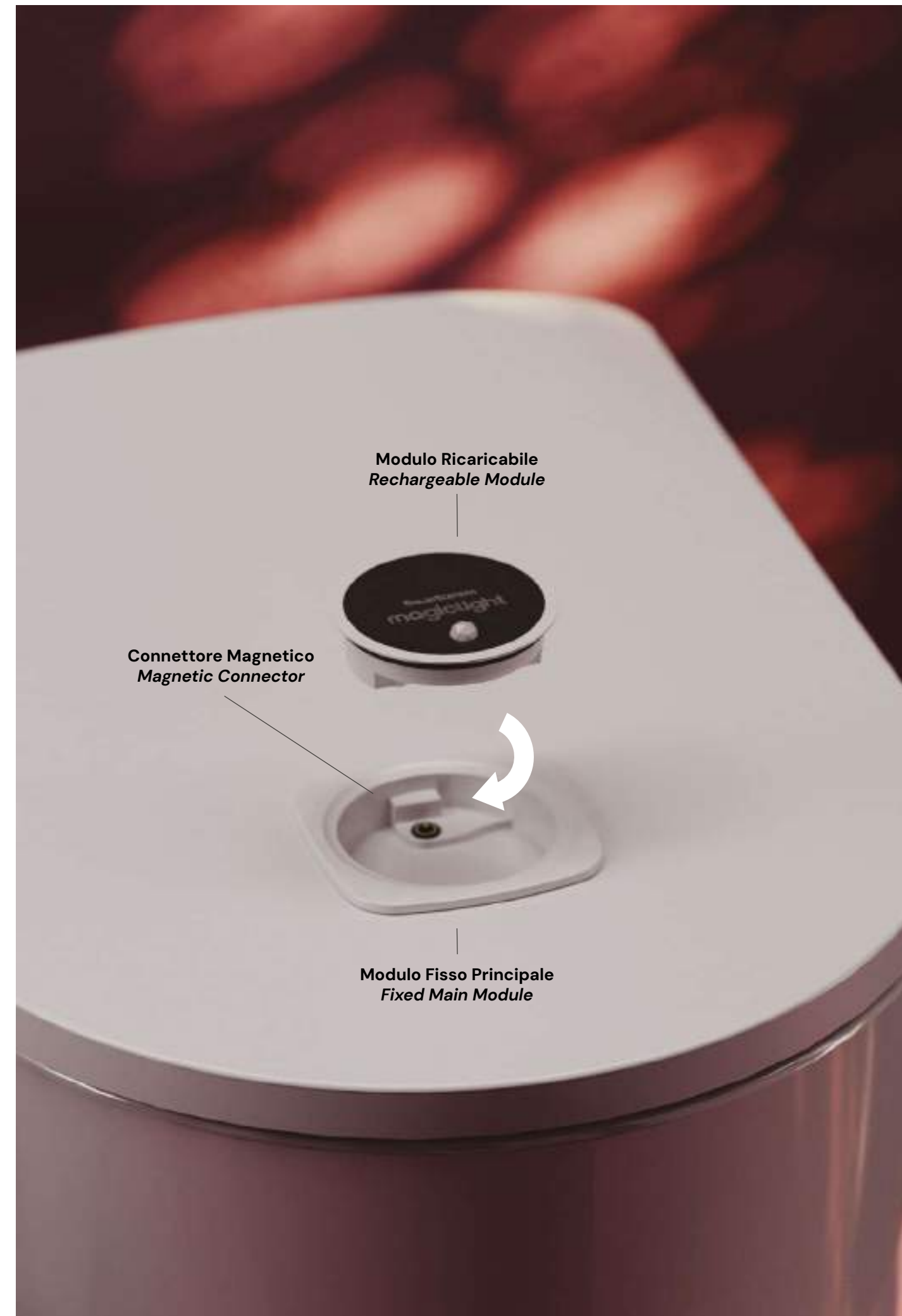



Guarda il video  
Watch the video



Sensore  
Sensor

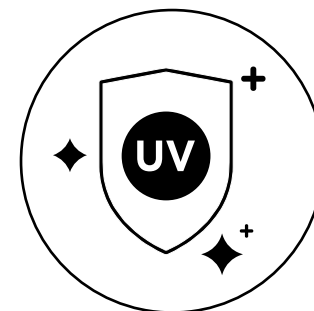

Sterilizzazione a raggi  
ultravioletti C (UVC)  
Ultraviolet - C (UVC)  
Sterilization

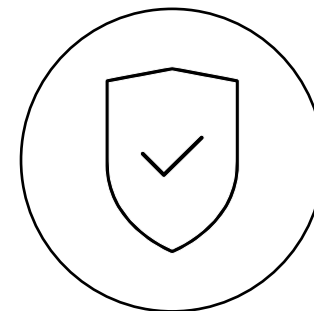
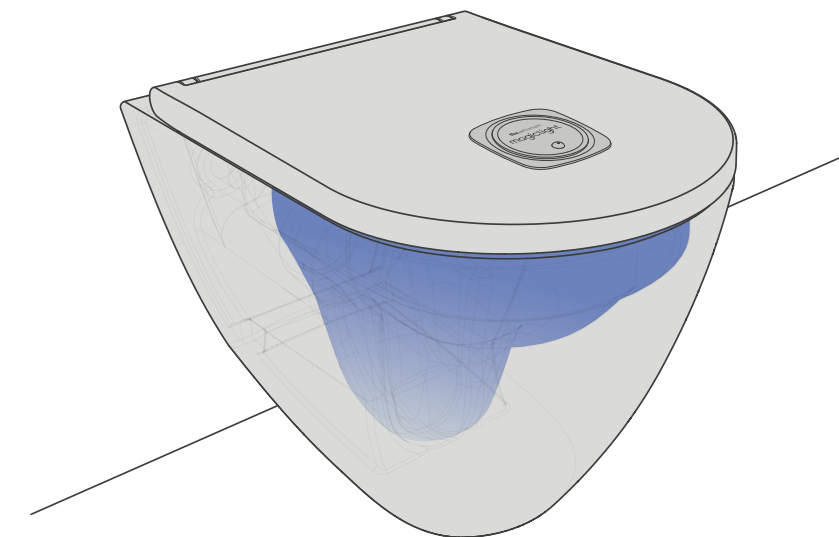

Sistema intelligente  
contro l'uso improprio  
Intelligent System  
Against Incorrect Use

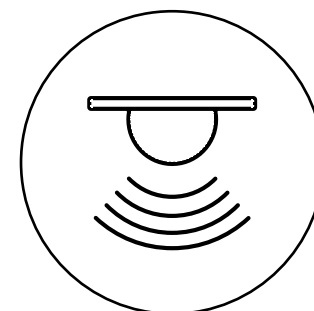
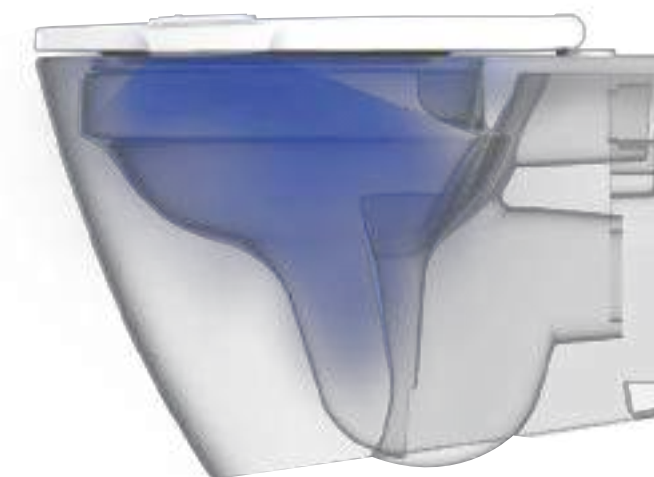

Sensore di movimento  
e luce ambientale  
Motion Sensor  
and Ambient Light

Indicatore  
Indicator

Sensore  
Sensor



Radiazione UVC  
e Luce Blu  
UVC Radiation  
and Blue Light

Pulsante di Accensione  
Touch  
Touch Power Button

# MAGICLIGHT SYSTEM

Igiene totale a 360°, sia per WC a terra che sospesi! Il nuovo sistema di igienizzazione è installabile su tutti i sedili delle seguenti collezioni, scopri qui di seguito:

*Total hygiene at 360°, for both back to wall and wall-hung WC! The new sanitation system is installable on all the seat covers of the following collections, discover them below:*

	vaso terra back to wall WC	vaso sospeso wall-hung WC		vaso terra back to wall WC	vaso sospeso wall-hung WC
<b>SOLIDA</b>			<b>FILE 2.0</b>		
<b>SETA</b>			<b>MONET &amp; MONET PLUS</b>		
<b>A16 &amp; A16 MINI</b>			<b>HYPE</b>		
<b>VITA</b>			<b>TEN</b>		
<b>ATELIER</b>					

# MAGICLIGHT OVERVIEW



## VITA/SOLIDA

codice	colore	kg	pz. pallet Italia	pz. pallet Export	euro
FLA016	○ 01; 20	3,5	-	-	295

seduta Flat per WC frizionata a sgancio rapido Magiclight

*easy take off soft-close  
Magiclight Flat WC seat*



## SETA

SEA001	○ 01; 20	3,5	-	-	295
--------	----------	-----	---	---	-----

seduta per WC frizionata a sgancio rapido Magiclight

*easy take off soft-close  
Magiclight WC seat*



## A16

ASA006	○ 01; 20	3,5	-	-	295
--------	----------	-----	---	---	-----

seduta per WC frizionata a sgancio rapido Magiclight

*easy take off soft-close  
Magiclight WC seat*



## A16 MINI

ASA002	○ 01; 20	3,5	-	-	295
--------	----------	-----	---	---	-----

seduta per WC frizionata a sgancio rapido Magiclight

*easy take off soft-close  
Magiclight WC seat*



## ATELIER/AZULEY

AZA001	○ 01; 20	3,5	-	-	295
--------	----------	-----	---	---	-----

seduta per WC frizionata a sgancio rapido Magiclight

*easy take off soft-close  
Magiclight WC seat*

# MAGICLIGHT OVERVIEW



## FILE 2.0

codice	colore	kg	pz. pallet Italia	pz. pallet Export	euro
FLA014	○ 20	3,5	-	-	295

seduta Slim per WC frizionata a sgancio rapido Magiclight

*easy take off soft-close  
Magiclight Slim WC seat*



## MONET

MNA001	○ 01; 20	3,5	-	-	295
--------	----------	-----	---	---	-----

seduta per WC frizionata a sgancio rapido Magiclight

*easy take off soft-close  
Magiclight WC seat*



## HYPE

HYA001	○ 01; 20	3,5	-	-	295
--------	----------	-----	---	---	-----

seduta per WC frizionata a sgancio rapido Magiclight

*easy take off soft-close  
Magiclight WC seat*



## TEN

TEA012	○ 01; 20	3,5	-	-	295
--------	----------	-----	---	---	-----

seduta per WC frizionata a sgancio rapido Magiclight

*easy take off soft-close  
Magiclight WC seat*

# THE. RIM LESS



Scopri online  
Discover it online

SISTEMA DI SCARICO SENZA BRIDA  
IGIENE COMPLETA E PULIZIA IMMEDIATA

# The.Rimless

Il sistema The.Rimless di Artceram rappresenta un'evoluzione sostanziale nell'igiene del WC: eliminando completamente la brida tradizionale, rimuove quelle parti nascoste dove sporco e batteri tendono ad accumularsi e risultano difficili da raggiungere. La superficie interna della tazza è così interamente visibile, accessibile e molto più semplice da pulire, riducendo la necessità di detergenti aggressivi e migliorando l'igiene quotidiana.



## ELIMINAZIONE DELLA BRIDA

ELIMINATION OF THE RIM

## FLUSSO OTTIMIZZATO

OPTIMIZED WASHING

## OTTIMIZZAZIONE LAVAGGIO

OPTIMIZED FLOW

The Artceram The.Rimless system represents a substantial evolution in toilet hygiene: by completely eliminating the traditional rim, it removes the hidden areas where dirt and bacteria tend to accumulate and are difficult to reach. The internal surface of the bowl is therefore fully visible, accessible, and much easier to clean, reducing the need for aggressive detergents and improving everyday hygiene.

During flushing, water flows continuously and in a controlled manner along the entire ceramic surface, evenly enveloping the bowl. This full and uniform flow ensures wide coverage, promotes effective waste removal, and significantly reduces stagnation, providing efficient cleaning with every use. The water path is designed to combine power and efficiency, delivering high performance with reduced water consumption and a fast, effective flush. The absence of a rim allows for a more essential and modern internal structure, enhancing both aesthetics and functionality. The.Rimless offers a more hygienic, efficient, and sustainable user experience, improving comfort and practicality in the bathroom.



Durante lo scarico, l'acqua scorre in modo continuo e controllato lungo tutta la ceramica, avvolgendo uniformemente la tazza. Questo flusso pieno e omogeneo garantisce un'ampia copertura, favorisce la dispersione dei residui e riduce i ristagni, assicurando una pulizia efficace ad ogni utilizzo. Il percorso dell'acqua è progettato per unire potenza ed efficienza, mantenendo elevate prestazioni con un ridotto consumo idrico e un risciacquo rapido. L'assenza della brida consente una struttura interna più essenziale e moderna, migliorando estetica e funzionalità. The.Rimless offre un'esperienza d'uso più igienica, efficiente e sostenibile, aumentando comfort e praticità nel bagno.

## THE.RIMLESS SYSTEM

Scopri qui di seguito tutti i WC delle collezioni The.Artceram dotati del sistema di scarico The.Rimless, la soluzione senza brida che garantisce una mappa interna più pulita e facilmente igienizzabile, eliminando il tradizionale bordo perimetrale.

*In the following section you can discover all the WC from The.Artceram collections equipped with The.Rimless flushing system, the rimless solution that ensures a cleaner, more hygienic inner surface by eliminating the traditional perimeter rim.*

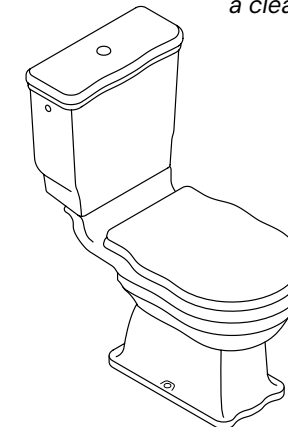

**HERMITAGE  
(HEV004)**

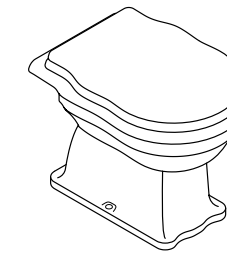

**HERMITAGE  
(HEV002)**

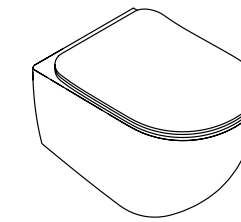

**FILE 2.0  
(FLV006)**

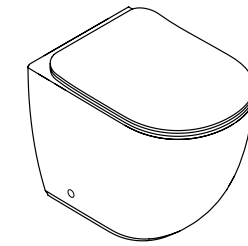

**FILE 2.0  
(FLV007)**

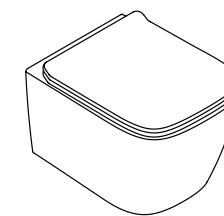

**A16 MINI  
(ASV005)**

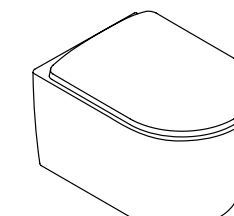

**MONET  
(MNV001)**

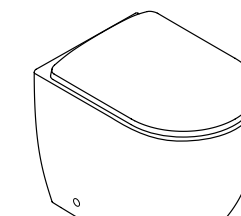

**MONET  
(MNV002)**

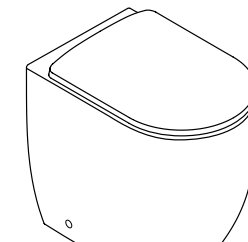

**MONET PLUS  
(MNV003)**

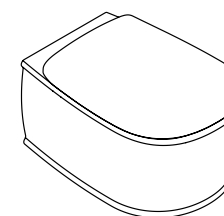

**ATELIER  
(ATV001)**

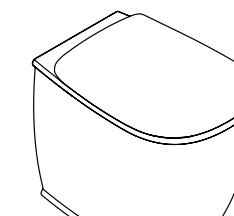

**ATELIER  
(ATV002)**

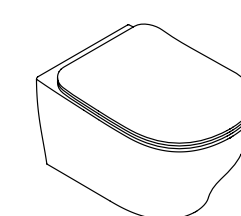

**TEN  
(TEV006)**

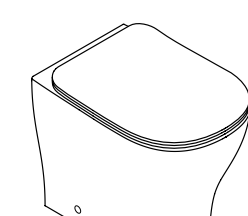

**TEN  
(TEV008)**

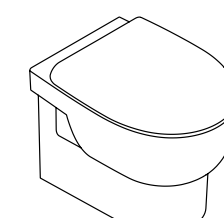

**SMARTY 2.0  
(SMV001)**

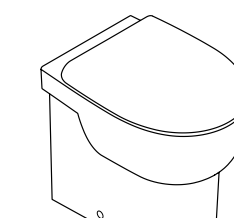

**SMARTY 2.0  
(SMV002)**

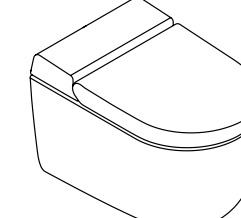

**HYPE  
(HYV001)**

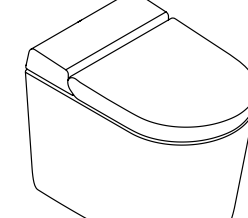

**HYPE  
(HYV002)**

# THE. REEL



Scopilo online  
Discover it online

VORTICE D'ACQUA POTENTE  
E SILENZIOSO PER UN RISCIACCO  
DINAMICO, EFFICIENTE E SOSTENIBILE



Guarda il video  
Watch the video

# The.Reel

Il nuovo sistema di scarico The.Reel rappresenta l'eccellenza tecnica firmata Artceram: un vortice d'acqua studiato per massimizzare l'efficienza del risciacquo, portando pulizia, igiene e sostenibilità a un livello superiore. Durante lo scarico, l'acqua segue un percorso preciso e vorticoso che copre uniformemente l'intera superficie interna del vaso, garantendo un risciacquo potente, completo e dinamico, più efficace rispetto ai sistemi tradizionali. Il sistema è universale e compatibile con tutte le cassette di scarico, sia quelle standard 6/3 litri, sia le versioni a risparmio idrico 4/2 litri. Questa flessibilità consente un'installazione senza limitazioni, mantenendo prestazioni elevate in ogni configurazione.

The new The.Reel flushing system represents Artceram's technical excellence: a water vortex engineered to maximize flushing efficiency, taking cleanliness, hygiene, and sustainability to a higher level. During flushing, the water follows a precise, swirling path that evenly covers the entire internal surface of the bowl, ensuring a powerful, complete, and dynamic flush that is more effective than traditional systems. The system is universal and compatible with all flush tanks, both standard 6/3-liter models and water-saving 4/2-liter versions. This flexibility allows for installation without limitations while maintaining high performance in every configuration.





# FLUSSO A VORTICE D'ACQUA

VORTEX FLUSHING SYSTEM

## IGIENE TOTALE

COMPLETE HYGIENE

## RIDUZIONE DEI CONSUMI

REDUCED WATER CONSUMPTION

## COMPATIBILITÀ UNIVERSALE

UNIVERSAL COMPATIBILITY

## SILENZIOSITÀ E COMFORT

QUIET OPERATION AND COMFORT

---

The internal design allows the vortex to reach every point of the ceramic surface, removing residues and deposits while reducing the use of detergents. The result is a perfectly clean sanitary fixture, with less waste and greater hygiene. The.Reel is also quiet and environmentally friendly: the optimized flow reduces flushing noise and uses limited amounts of water, delivering efficiency that combines comfort, performance, and sustainability. The.Reel brings together form and function: toilets equipped with this system are elegant, ideal for a modern bathroom, yet at the same time highly high-performing. A technology that expresses Artceram's commitment to responsible design: less waste, greater hygiene, and superior user quality.

Il design interno permette al vortice di raggiungere ogni punto della ceramica, rimuovendo residui e depositi e riducendo l'uso di detersivi. Il risultato è un sanitario perfettamente pulito, con meno sprechi e maggiore igiene. The.Reel è inoltre silenzioso e rispettoso dell'ambiente: il flusso ottimizzato riduce il rumore dello scarico e utilizza quantità d'acqua contenute, con un'efficienza che unisce comfort, performance e sostenibilità. The.Reel combina forma e funzione: i vasi dotati di questo sistema sono eleganti, perfetti per un bagno moderno ma al tempo stesso altamente performanti. Una tecnologia che esprime l'impegno di Artceram verso un design responsabile: meno sprechi, più igiene e una qualità d'uso superiore.



# THE.REEL SYSTEM

Scopri qui di seguito tutti i WC delle collezioni The.Artceram dotati del sistema di scarico The.Reel, che sfrutta un flusso a vortice per ottimizzare la pulizia della vasca interna; questa tecnologia innovativa garantisce un'efficienza dello scarico ancora maggiore.

## SOLIDA

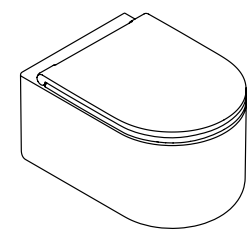

(SOV001)

## SETA

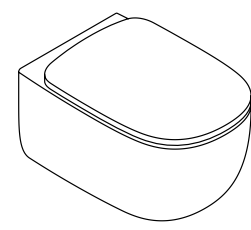

(SEV001)

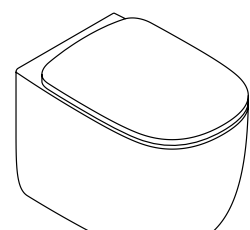

(SEV002)

## A16

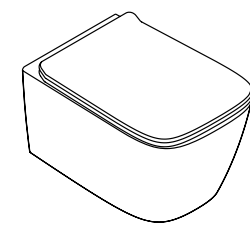

(ASV006)

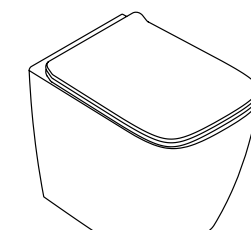

(ASV007)

## VITA

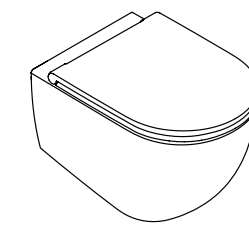

(VIV001)

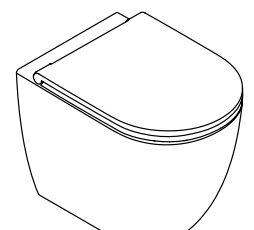

(VIV002)

*In the following section you can discover all the WC from The.Artceram collections equipped with The.Reel flushing system, which uses a vortex flow to optimize the cleaning of the bowl; this innovative technology ensures even greater flushing efficiency.*

# FURNI TURE

ARREDI E STRUTTURE  
THE.ARTCERAM

BROOKLYN (P.96)

OPERA (P.106)

MONO (P.116)

RELAX (P.126)

CHURCH (P.148)

# BROOKLYN



Scopri online  
Discover it online



FURNITURE



Collezione di strutture  
con cassettone integrato  
per lavabi Brooklyn 90 e 65



Collection of structures with  
integrated drawer units for  
Brooklyn 90 and 65 washbasins



## STRUCTURES COLLECTION

The bridge between design and function.  
The Brooklyn structure is designed exclusively for the washbasins of the same collection, creating a harmonious and coherent bathroom system. A “stand” crafted in solid Canaletto walnut, it stands out for the elegant curvature of its legs, which conveys lightness and dynamism, while incorporating a functional detail: the refined integrated knob that doubles as a towel holder.

# Il ponte tra design e funzione.

La struttura Brooklyn è progettata esclusivamente per i lavabi della stessa collezione, creando un sistema bagno armonico e coerente. Un “cavalletto” realizzato in massello di noce canaletto, si distingue per la curvatura elegante delle gambe, che conferisce leggerezza e dinamismo, e crea un dettaglio funzionale: il raffinato pomello integrato che funge da porta asciugamano.

**BNL002 + ACM044 | 90 x 40**  
Lavabo con struttura dedicata in massello noce canaletto con cassettone integrato laccato color moka matt  
*Washbasin with structure in solid Canaletto walnut with integrated drawer lacquered in matt moka color*





**BNL003 + ACM043 | 65 x 40**  
Lavabo con struttura dedicata  
in massello noce canaletto  
con cassettone integrato  
laccato color moka matt  
*Washbasin with structure  
in solid Canaletto walnut  
with integrated drawer  
lacquered in matt moka color*



The integrated drawer, lacquered in matt moka, is designed to offer dual functionality: the top section serves as a small recessed “tray” for storage, while the rounded side edges enhance the design, perfectly combining aesthetics and practicality. Available for Brooklyn 90 and 65 washbasins, the structure completes the sinks by providing order, elegance, and a sophisticated character. It transforms any bathroom into a refined, perfectly coordinated space where solid wood interacts seamlessly with the modern lines of the ceramic.

Il cassettone integrato, laccato moka matt, è studiato per offrire una doppia funzionalità: la parte superiore funge da piccolo “vassoio contenitivo”, leggermente incassata rispetto all’anta, mentre i laterali stondati che sbordano ne valorizzano il design, combinando estetica e praticità. Disponibile per i lavabi Brooklyn 90 e 65, la struttura completa i lavabi garantendo ordine, eleganza e un carattere sofisticato. Trasforma ogni bagno in uno spazio raffinato e perfettamente coordinato, dove il legno massello dialoga con le linee moderne della ceramica.

# BROOKLYN STYLES

## CLASSIC COLORS



cod. 01  
bianco lucido / glossy white



cod. 05  
bianco matt / matt white



cod. 17  
nero matt / matt black

## MATT COLORS



cod. 15  
grigio oliva / grey olive



cod. 38  
blu avio / blue avio



cod. 41  
marrone matera / brown matera



cod. 59  
sabbia / sand



cod. 60  
ghiaia / gravel

## GLOSSY COLORS



cod. 67  
curcuma / turmeric



cod. 68  
paprika / paprika



cod. 69  
edera / ivy



cod. 70  
zefiro / zephyr

## STORAGE



moka / moka  
RAL 8014



noce canaletto / canaletto walnut

\*Unica combinazione colore disponibile per le strutture  
Only colour combination available for the structures

# BROOKLYN OVERVIEW



## BROOKLYN 90 | 90 x 40

lavabo rettangolare appoggio/  
sospeso/per struttura dedicata  
senza foro (predisposto 3 fori),  
con Saniglaze

rectangular countertop/wall-hung/  
for structure washbasin no hole  
with arrangements  
for 3 holes, with Saniglaze



schede tecniche  
technical drawing

codice	colore	kg	pz. pallet Italia	pz. pallet Export	euro
--------	--------	----	-------------------	-------------------	------

### CLASSIC COLORS

<b>BNL002</b>	○ 01	34	25	12	24	580
<b>BNL002</b>	⊙ 05	34	25	12	24	930
<b>BNL002</b>	● 17	34	25	12	24	930

### MATT COLORS

<b>BNL002</b>		34	25	12	24	930
---------------	--	----	----	----	----	-----

### GLOSSY COLORS

<b>BNL002</b>		34	25	12	24	930
---------------	--	----	----	----	----	-----



struttura per lavabo Brooklyn 90  
in massello noce canaletto  
con cassettone integrato  
laccato color moka matt

structure for washbasin Brooklyn  
90 in solid Canaletto walnut  
with integrated drawer  
lacquered in matt moka color



schede tecniche  
technical drawing

<b>ACM044</b>		25	-	-	3400
---------------	--	----	---	---	------

# BROOKLYN OVERVIEW



THE.  
SANIGLAZE

## BROOKLYN 65 | 65 x 40

lavabo rettangolare appoggio/  
sospeso/per struttura dedicata  
senza foro (predisposto 3 fori),  
con Saniglaze

rectangular countertop/wall-hung/  
for structure washbasin no hole  
with arrangements  
for 3 holes, with Saniglaze



schede tecniche  
technical drawing

codice	colore	kg	pz. pallet Italia	pz. pallet Export	euro	
CLASSIC COLORS						
<b>BNL003</b>	○ 01; 34	19	20	33	<b>550</b>	
<b>BNL003</b>	◎ 05; 34	19	20	33	<b>880</b>	
<b>BNL003</b>	● 17; 34	19	20	33	<b>880</b>	
MATT COLORS						
<b>BNL003</b>		34	19	20	33	<b>880</b>
GLOSSY COLORS						
<b>BNL003</b>		34	19	20	33	<b>880</b>



struttura per lavabo Brooklyn 65  
in massello noce canaletto  
con cassettone integrato  
laccato color moka matt

structure for washbasin Brooklyn  
65 in solid Canaletto walnut  
with integrated drawer  
lacquered in matt moka color



schede tecniche  
technical drawing

<b>ACM043</b>		20	-	-	<b>3200</b>
---------------	--	----	---	---	-------------

# BROOKLYN ACCESSORIES

piletta universale  
up & down cromo

chrome up & down drain

piletta universale up & down  
con tappo in ceramica,  
con Saniglaze

up & down universal drain with  
ceramic cover for washbasins,  
with Saniglaze

piletta cromo con troppo pieno  
integrato  
chrome drain with integral  
overflow

piletta con tappo in ceramica  
e troppo pieno integrato,  
con Saniglaze

drain with ceramic cover  
and integral overflow,  
with Saniglaze

sifone cilindrico cromo  
chrome siphon

sifone cilindrico - siphon

codice	colore	kg	pz. pallet Italia	pz. pallet Export	euro	
<b>ACA032</b>		0,3	-	-	<b>75</b>	
CLASSIC COLORS						
<b>ACA036</b>	○ 01; 34	0,3	-	-	<b>80</b>	
<b>ACA038</b>	◎ 05; 34	0,3	-	-	<b>90</b>	
<b>ACA038</b>	● 17; 34	0,3	-	-	<b>90</b>	
MATT COLORS						
<b>ACA038</b>		34	0,3	-	-	<b>90</b>
GLOSSY COLORS						
<b>ACA038</b>		34	0,3	-	-	<b>90</b>

<b>ACA096</b>		0,3	-	-	<b>85</b>
---------------	--	-----	---	---	-----------

codice	colore	kg	pz. pallet Italia	pz. pallet Export	euro	
CLASSIC COLORS						
<b>ACA097</b>	○ 01; 34	0,3	-	-	<b>90</b>	
<b>ACA097</b>	◎ 05; 34	0,3	-	-	<b>90</b>	
<b>ACA097</b>	● 17; 34	0,3	-	-	<b>90</b>	
MATT COLORS						
<b>ACA097</b>		34	0,3	-	-	<b>90</b>
GLOSSY COLORS						
<b>ACA097</b>		34	0,3	-	-	<b>90</b>

<b>ACA022</b>		1	-	-	<b>130</b>
---------------	--	---	---	---	------------

<b>ACA099</b>	◎ 05	1	-	-	<b>180</b>
<b>ACA099</b>	● 17	1	-	-	<b>180</b>

# OPE RA



Scopri online  
Discover it online

Mobile tondo  
per lavabi d'appoggio

Round furniture  
for countertop washbasins



# STORAGE COLLECTION

Slim Lines, Hidden Functions.  
Opera is halfway between a freestanding washbasin and a storage unit. A cylindrical column, decorated with slim-rod-like texture supports and enhance the accompanying washbasins of Opera - and not only - by elevating them to real freestanding washbasins.

# Linee sottili, funzioni segrete.

Opera si pone a cavallo tra lavabo centro-stanza e mobile contenitore. Una colonna cilindrica, decorata da una texture cannettata, sorregge ed eleva a veri e propri centro-stanza, i lavabi a corredo di Opera e non solo.

ACM042 | Ø 40 h 72  
Mobile tondo  
per lavabi appoggio  
Round furniture  
for countertop washbasins  
muschio / musk

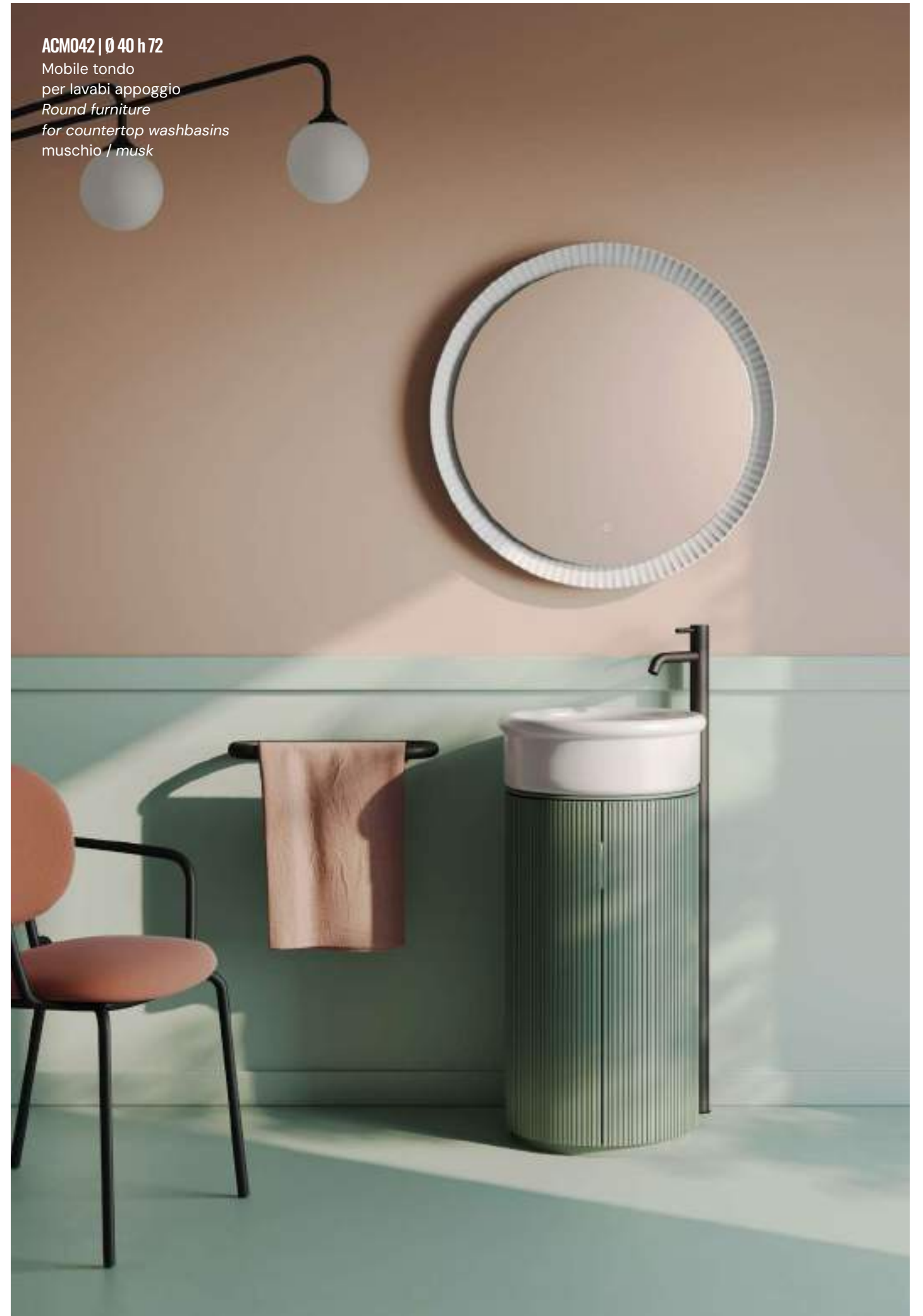

**ACM042 | Ø 40 h 72**

Mobile tondo  
per lavabi appoggio  
Round furniture  
for countertop washbasins  
platino / platinum



**ACM042 | Ø 40 h 72**

Mobile tondo  
per lavabi appoggio  
Round furniture  
for countertop washbasins  
pavone / peacock

The particular design of milled lines that characterizes the "millerighe" surface texture, expertly hides the curved door opening lines of the comfortable inner storage.

L'andamento delle linee fresate, che compone la texture millerighe superficiale, nasconde brillantemente le linee che demarcano l'apertura dell'anta curva che dà accesso ad un comodo storage interno.

# OPERA SYSTEM

Il fusto di Opera può sorreggere i lavabi della produzione Artceram.  
Una "colonna minimal" dalle dimensioni contenute, un piccolo storage dal gusto estetico ricercato!

*The pillar of Opera can support the washbasins made by Artceram.  
A "minimal column" with small dimensions, a little storage with a refined aesthetic taste!*

**BRERA (BRL001)**  
lavabo appoggio  
countertop washbasin  
Ø43

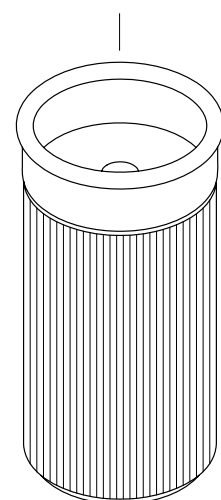

**COGNAC 42 (COL001)**  
lavabo appoggio  
countertop washbasin  
Ø42

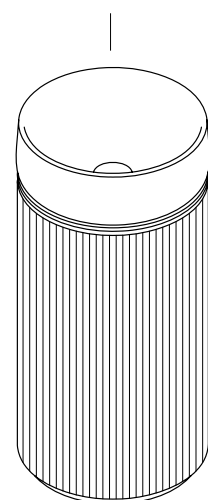

**COGNAC 35 (COL004)**  
lavabo appoggio  
countertop washbasin  
Ø35

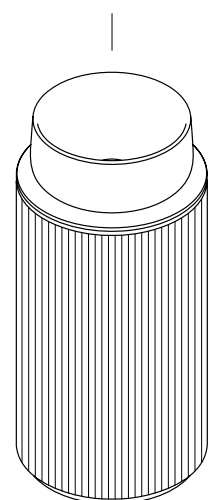

**COGNAC 48 (COL002)**  
lavabo appoggio  
countertop washbasin  
Ø48

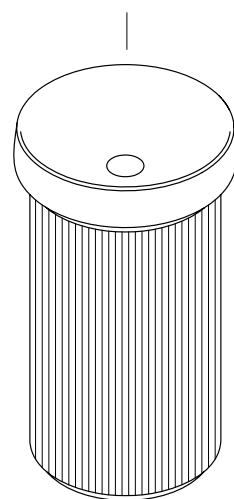

**WON 44 (WNL002)**  
lavabo appoggio  
countertop washbasin  
Ø44

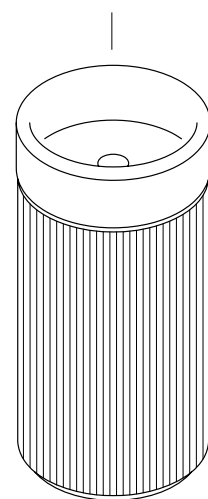

## ACM042 | Ø 40 h 72

Mobile tondo  
per lavabi appoggio  
Round furniture  
for countertop washbasins  
pavone / peacock



# OPERA COMBINATION

## STEP 1

Scegli il lavabo d'appoggio  
Choose the countertop washbasin

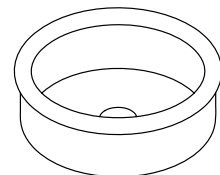

BRERA (BRL001)

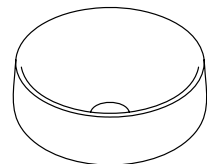

COGNAC 42 (COL001)

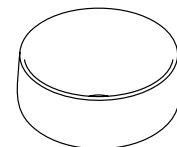

COGNAC 35 (COL004)

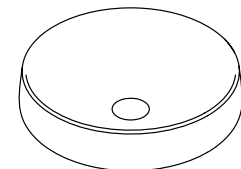

COGNAC 48 (COL002)

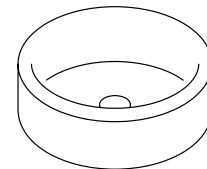

WON 44 (WNL002)

## STEP 2

Scegli il colore dello storage  
Choose the color of the storage

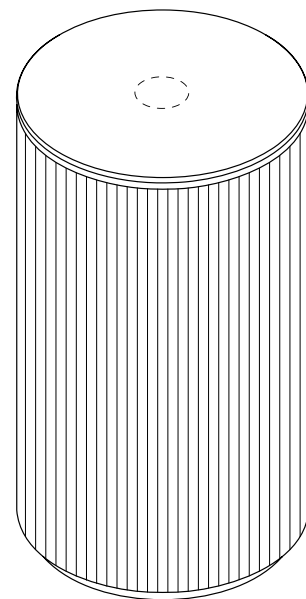

Per le specifiche dei lavabi consigliati andare a pag. 410  
All the specifications of the recommended washbasins at page 410

# OPERA STYLES

## STORAGE



cod. 05  
bianco matt / matt white  
RAL 9016



cod. 17  
nero matt / matt black  
RAL 9005



cod. 56  
moka / moka  
RAL 8014



cod. 52  
platino / platinum  
RAL 7036



cod. 57  
pavone / peacock  
RAL 7031



cod. 58  
muschio / musk  
RAL 7033

FURNITURE

# OPERA OVERVIEW



## OPERA | Ø 40 h 72

mobile tondo per lavabi appoggio  
con piletta cromo  
filettata inclusa nel prezzo

*round furniture for countertop  
washbasins with threaded  
chrome drain included  
in the price*



schede tecniche  
technical drawing

codice	colore	kg	pz. pallet Italia	pz. pallet Export	euro
STORAGE					
<b>ACM042</b>		19	-	-	<b>2600</b>

# MONO NO



Scopri online  
Discover it online

Mobile quadro  
per lavabi d'appoggio

Square furniture  
for countertop washbasins



# STORAGE COLLECTION

Vertical geometry.  
Mono, like Opera, stands halfway between a freestanding washbasin and a storage unit. A sleek and lightweight parallelepiped, enhanced by a slim-rod-like texture, rises as a structural column supporting the countertop base for the accompanying washbasins.

# Geometria verticale.

Mono, come Opera, si colloca a metà strada tra un lavabo centro-stanza e un mobile contenitore. Un parallelepipedo snello e leggero, caratterizzato da una texture cannettata, si eleva come una colonna strutturale in grado di sorreggere la base d'appoggio per i lavabi a corredo del mobile bagno.





**ACM041 | 039 h 72**  
 Mobile quadro  
 per lavabi appoggio  
 Square furniture  
 for countertop washbasins  
 pavone / peacock

The milled "slim-rod" surface lightens and gives impetus to the architectural block, turning the brutalist structure of the Mono column/furniture into a refined, essential, and sculptural element.

La superficie millerighe alleggerisce e conferisce slancio alla massa architettonica del volume, trasformando la struttura brutalista della colonna/mobile Mono in un elemento raffinato, essenziale e scultoreo.

# MONO SYSTEM

Come un moderno piedistallo nella zona bagno/museale, Mono può sorreggere i lavabi Artceram consigliati nello schema grafico qui di seguito.

*Like a modern pedestal in the bathroom/museum area, Mono can support the Artceram washbasins recommended in this graphic diagram.*

**BRERA (BRL001)**  
lavabo appoggio  
countertop washbasin  
Ø43

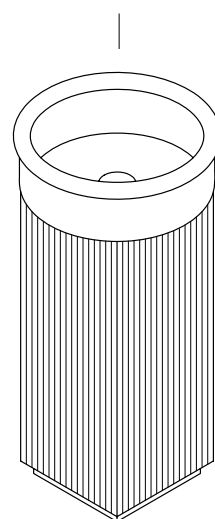

**COGNAC 42 (COL001)**  
lavabo appoggio  
countertop washbasin  
Ø42

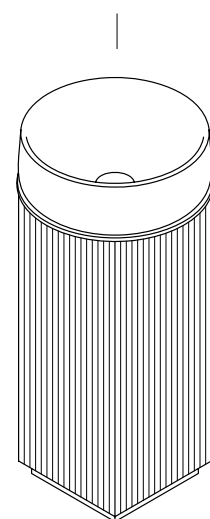

**COGNAC 35 (COL004)**  
lavabo appoggio  
countertop washbasin  
Ø35

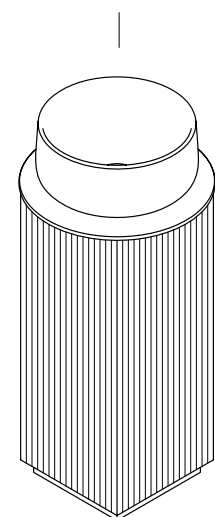

**COGNAC 48 (COL002)**  
lavabo appoggio  
countertop washbasin  
Ø48

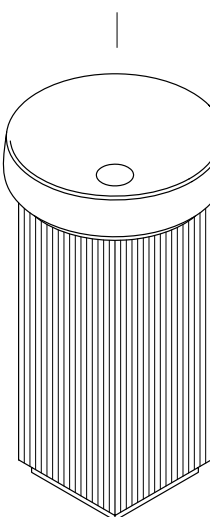

**ACM041 | Ø 39 h 72**  
Mobile quadro  
per lavabi appoggio  
Square furniture  
for countertop washbasins  
platino / platinum

# MONO COMBINATION

## STEP 1

Scegli il lavabo d'appoggio  
Choose the countertop washbasin

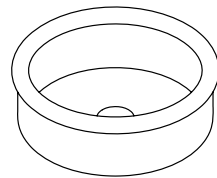

BRERA (BRL001)

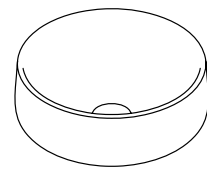

COGNAC 42 (COL001)

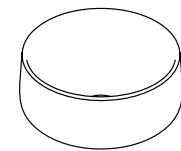

COGNAC 35 (COL004)

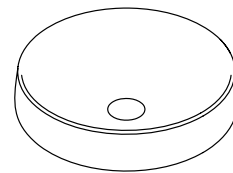

COGNAC 48 (COL002)

## STEP 2

Scegli il colore dello storage  
Choose the color of the storage

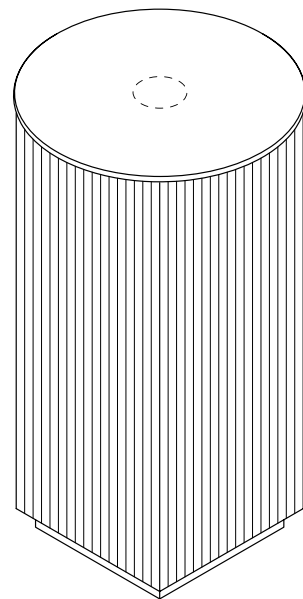

Per le specifiche dei lavabi consigliati andare a pag. 410  
All the specifications of the recommended washbasins at page 410

# MONO STYLES

## STORAGE



cod. 05  
bianco matt / matt white  
RAL 9016



cod. 17  
nero matt / matt black  
RAL 9005



cod. 56  
moka / moka  
RAL 8014



cod. 52  
platino / platinum  
RAL 7036



cod. 57  
pavone / peacock  
RAL 7031



cod. 58  
muschio / musk  
RAL 7033

# MONO OVERVIEW



## MONO | Ø 39 h 72

mobile quadro per lavabi appoggio  
con piletta cromo  
filettata inclusa nel prezzo

*square furniture for countertop  
washbasins with threaded  
chrome drain included  
in the price*



schede tecniche  
technical drawing

codice	colore	kg	pz. pallet Italia	pz. pallet Export	euro
STORAGE					
<b>ACM041</b>		18,5	-	-	<b>1600</b>

# RELAX



Scopri online  
Discover it online

Mobile componibile  
per lavabi d'appoggio

Customizable furniture  
for countertop washbasins



# MODULAR STORAGE COLLECTION

Tailored Elegance.  
Not just bathrooms but true spaces of wellbeing: moments disconnected from the outside, places of reflection and self-care. Relax is a strong yet warm and welcoming proposal, designed to make you feel at home. The wavy slatted surface is the hallmark of this collection, versatile and customizable in many ways.

# Eleganza su misura.

Non solo bagni, ma spazi di benessere: momenti disconnessi dall'esterno, luoghi di riflessi e cura di sé. Relax è una proposta dal carattere deciso ma al tempo stesso calda e accogliente, capace di far sentire a casa. Protagonista della collezione è il dogato a onde, versatile e personalizzabile in diverse soluzioni.

**ACM260 + AMC160 | 60 x 46**  
Base con cassetto+ anta  
*Base with drawer + door*  
bruma

**ACM130 | 30 x 46**  
Base a giorno  
*Open base*  
bruma

**ACA100**  
Top laccato  
*Lacquered top*  
bruma

**ACA102**  
Accessorio in metallo  
con portasciugamani  
*Metal accessory  
with towelholder*  
bianco matt / *matt white*



**ACM260 + AMC160 | 60 x 46**

Base con cassetto talpa  
+ anta grafite  
*Talpa base with drawer  
+ graphite door*

**ACM130 (x2) | 30 x 46**

Base a giorno  
*Open base  
talpa*

**ACA100**

Top laccato  
*Lacquered top  
talpa*

**ACA102**

Accessorio in metallo  
con portasciugamani  
*Metal accessory  
with towelholder  
moka*



Relax is much more than a bathroom cabinet: entirely designed and made in Italy, it adapts to every home. Length, finishes (plain or light/dark walnut), the number and position of countertop washbasins, open compartments and drawers can all be tailored during the project. What remains constant are taste, elegance and contemporary design.

Relax è molto più di un semplice mobile bagno: progettato e prodotto interamente in Italia, si adatta a ogni esigenza abitativa. La lunghezza, le finiture (in tinta unita o in noce chiaro/scuro), il numero e la posizione dei lavabi, dei vani a giorno e dei cassetti possono essere definiti in fase di progetto. Rimangono costanti il gusto, l'eleganza e il design contemporaneo.



**ACM270 + AMC170 | 70 x 46**  
 Base con cassetto bordeaux  
 + anta noce scuro  
*Bordeaux base with drawer  
 + noce scuro door*

**ACM140 | 40 x 76**  
 Base a giorno  
*Open base  
 bordeaux*

**ACA100**  
 Top laccato  
*Lacquered top  
 bordeaux*

**ACA102**  
 Accessorio in metallo  
 con portasciugamani  
*Metal accessory  
 with towelholder  
 nero matt / matt black*



**ACM260 + AMC160 | 60 x 46**

Base con cassetto fumo di Londra  
+ anta noce scuro  
*Fumo di Londra base with drawer  
+ noce scuro door*

**ACM270 + AMC167 | 70 x 46**

Base con cassetto fumo di Londra  
+ anta noce scuro  
*Fumo di Londra base with drawer  
+ noce scuro door*

**ACA100**

Top laccato  
*Lacquered top  
fumo di Londra*

**ACA102**

Accessorio in metallo  
con portasciugamani  
*Metal accessory  
with towelholder  
nero matt / matt black*





**ACM260 + AMC160 (x2) | 60 x 46**

Base con cassetto visone  
+ anta noce chiaro  
*Bisone base with drawer  
+ noce chiaro door*

**ACM130 | 30 x 46**

Base a giorno  
*Open base  
visone*

**ACA100**

Top laccato  
*Lacquered top  
visone*

**ACA102**

Accessorio in metallo  
con portasciugamani  
*Metal accessory  
with towelholder  
moka*

# RELAX MODULES

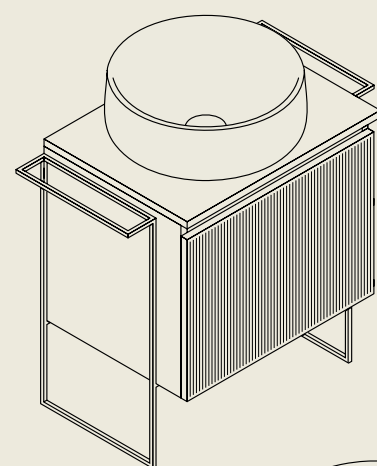

BASE 60 CM (ACM260)  
ANTA/DOOR 60 CM (ACM160)

.....  
ACCESSORIO CON PORTA ASCIUGAMANI/  
ACCESSORY WITH TOWELHOLDER (ACA102)

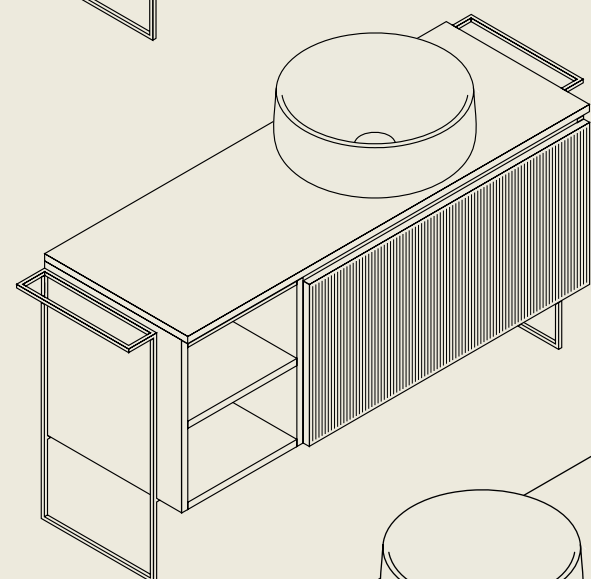

BASE A GIORNO/OPEN BASE 35 CM (ACM135)

BASE 90 CM (ACM290)  
ANTA/DOOR 90 CM (ACM190)

.....  
ACCESSORIO CON PORTA ASCIUGAMANI/  
ACCESSORY WITH TOWELHOLDER (ACA102)

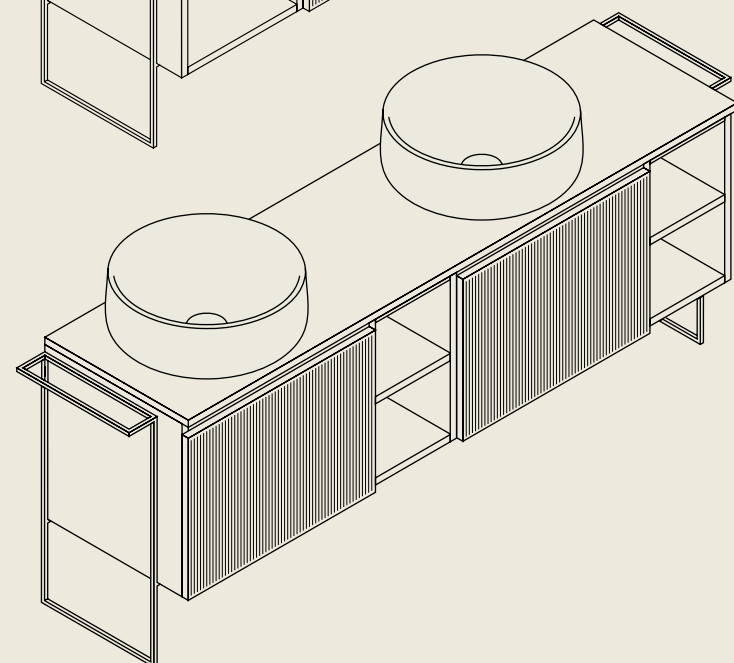

BASE 60 CM (ACM260)  
ANTA/DOOR 60 CM (ACM160)

.....  
BASE A GIORNO/OPEN BASE 30 CM (ACM130)

ACCESSORIO CON PORTA ASCIUGAMANI/  
ACCESSORY WITH TOWELHOLDER (ACA102)

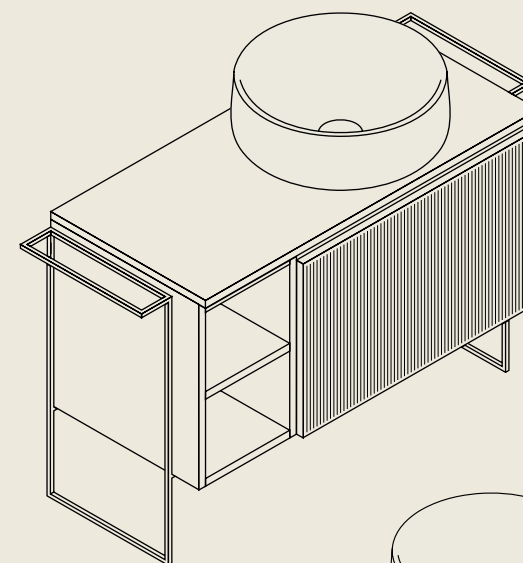

BASE A GIORNO/OPEN BASE 25 CM (ACM125)

BASE 70 CM (ACM270)  
ANTA/DOOR 70 CM (ACM170)

.....  
ACCESSORIO CON PORTA ASCIUGAMANI/  
ACCESSORY WITH TOWELHOLDER (ACA102)

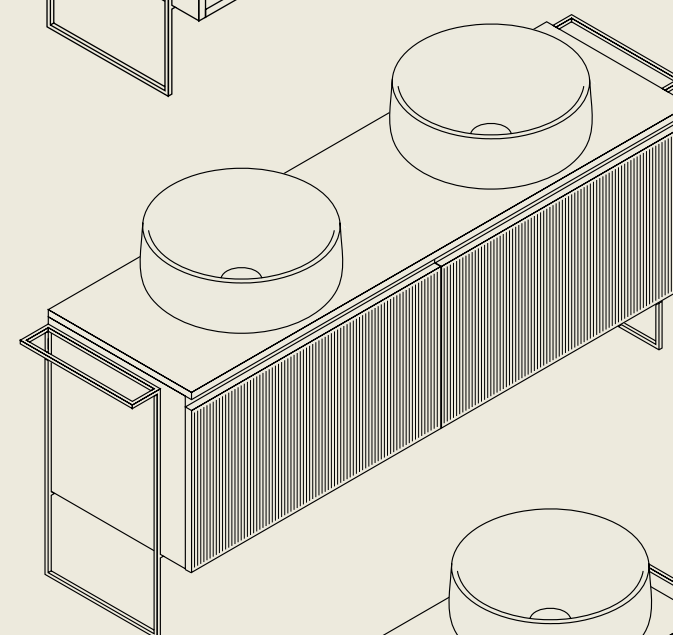

BASE 80 CM (ACM280)  
ANTA/DOOR 80 CM (ACM180)

.....  
ACCESSORIO CON PORTA ASCIUGAMANI/  
ACCESSORY WITH TOWELHOLDER (ACA102)

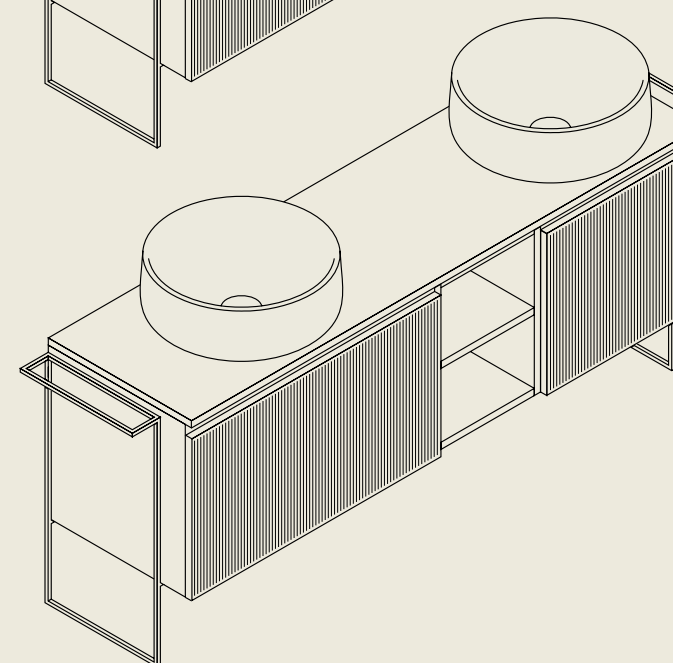

BASE 80 CM (ACM280)  
ANTA/DOOR 80 CM (ACM180)

BASE A GIORNO/OPEN BASE 30 CM (ACM130)

.....  
BASE 60 CM (ACM260)  
ANTA/DOOR 60 CM (ACM160)

ACCESSORIO CON PORTA ASCIUGAMANI/  
ACCESSORY WITH TOWELHOLDER (ACA102)

La modularità è il valore aggiunto di Relax. Puoi adattare ogni composizione al tuo gusto e al tuo ambiente; a uno o due lavabi, con uno più vani a giorno, con allineamenti centrali o laterali, selezionando la finitura che preferisci, potrai rendere unico il tuo mobile bagno. I pratici portasciugamani ai lati rimangono, per il resto diamo forma ai tuoi desideri.

Modularity is the added value of Relax. You can compose it according to your taste and environment. With one or two washbasins, with one or more stores, centrally or laterally aligned by selecting your favourite finish and making your bathroom furniture unique. The functional towel rails are at the users' sides, for the rest, your desires take shape.

# RELAX SYSTEM

## STEP 1

Scegli il lavabo d'appoggio tra quelli consigliati qui di seguito  
Choose the countertop washbasin among those recommended below

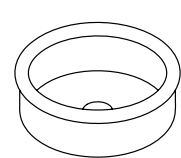

BRERA (BRL001)

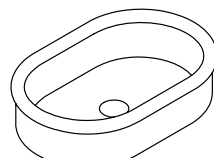

BRERA (BRL003)

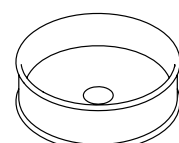

ATELIER (ATL001)

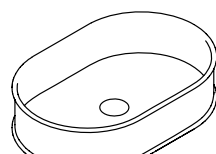

ATELIER (ATL002)

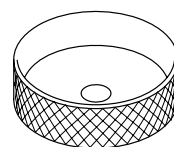

ROMBO (OSL009)

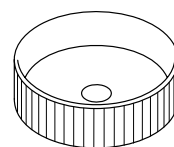

MILLERIGHE (OSL010)

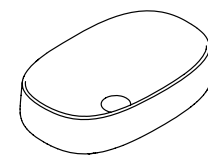

COGNAC 55 (COL003)

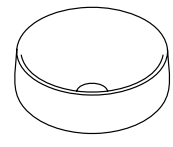

COGNAC 42 (COL001)

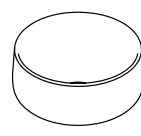

COGNAC 35 (COL004)

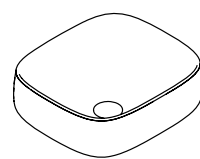

COGNAC QUADRO (COL007)

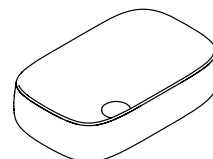

COGNAC QUADRO (COL008)

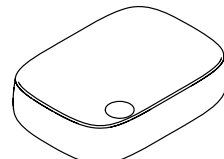

COGNAC QUADRO (COL009)

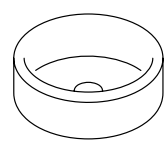

WON (WNL002)

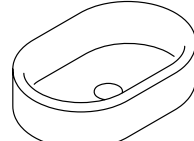

WON (WNL001)

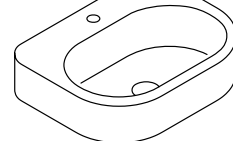

WON (WNL003)

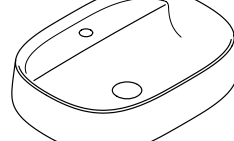

WHISKY (WHL002)

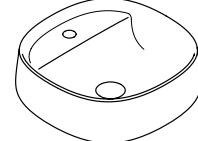

WHISKY (WHL001)

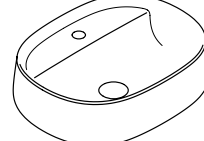

WHISKY (WHL003)

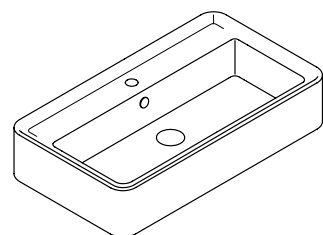

RODOLFO 80 (ROL001)

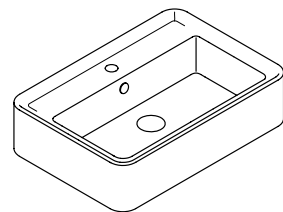

RODOLFO 65 (ROL002)

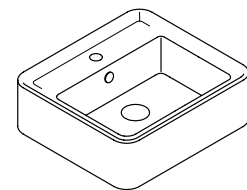

RODOLFO 50 (ROL003)

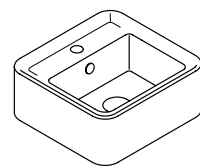

RODOLFO 40 (ROL004)

Per le specifiche dei lavabi consigliati andare a pag. 410  
All the specifications of the recommended washbasins at page 410

# RELAX SYSTEM

## STEP 2

Componi il tuo mobile con la base lavabo, l'anta cannettata, eventuale base a giorno, top e accessori laterali  
Compose your furniture with the washbasin base unit, pleated door, any open base unit, top and lateral accessories

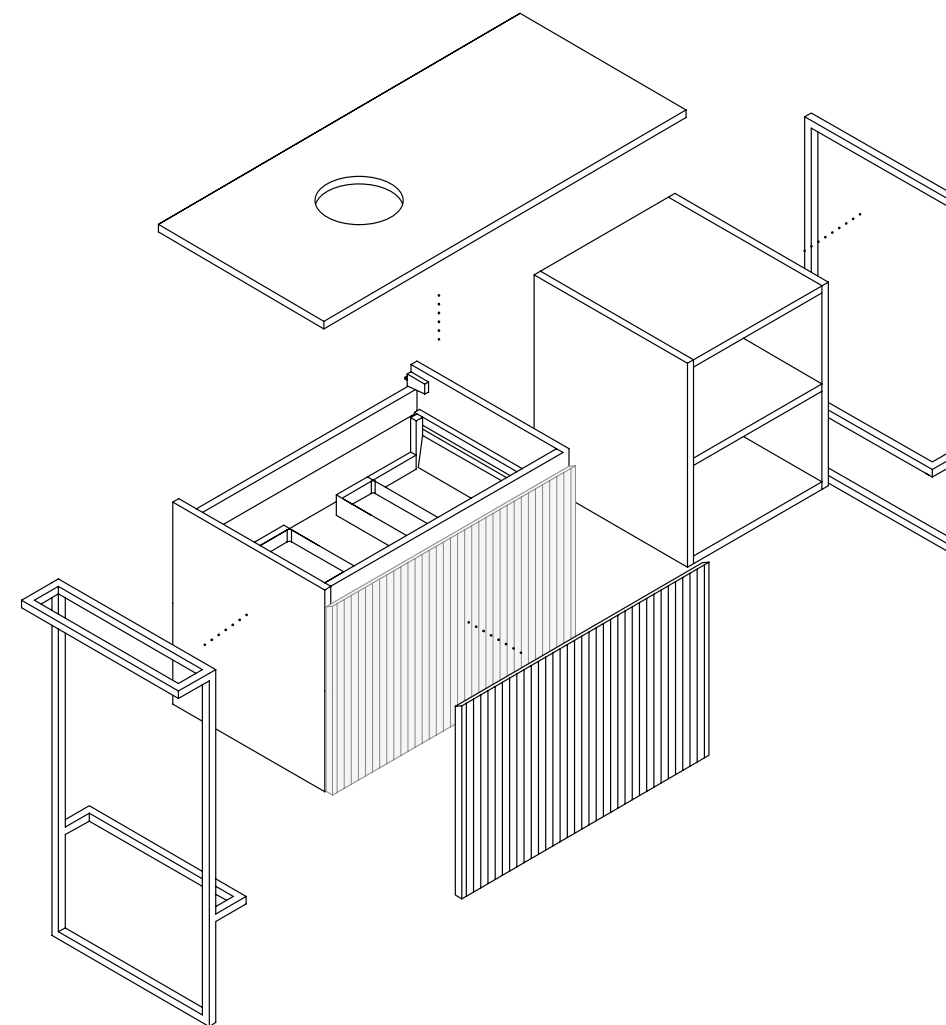

istruzioni montaggio  
assembly instructions



schede tecniche  
technical drawing

# RELAX FAUCET PLACEMENT

Artceram dà la possibilità di forare il top Relax per l'installazione del lavabo e rubinetto  
 Artceram gives the possibility to punch the top Relax for the installation of the basin and the faucet

## SCHEMA 1 (SCH101)

Foro lavabo "A" centrato su base con cassetto  
 Hole for basin "A" centered on the base with drawer

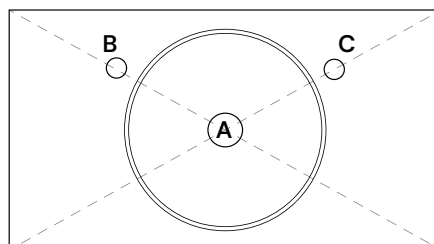

## SCHEMA 2 (SCH201)

Foro lavabo "A" centrato su base con cassetto sinistro  
 Hole for basin "A" centered on the base with left drawer

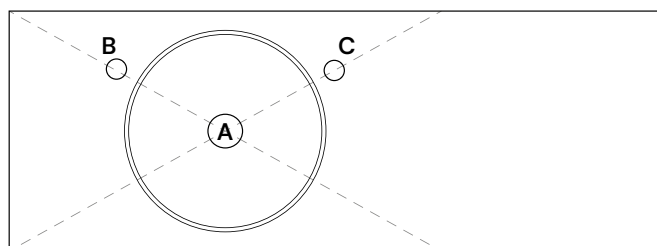

## SCHEMA 3 (SCH301)

Foro lavabo "A" centrato su base con cassetto destro  
 Hole for basin "A" centered on the base with right drawer

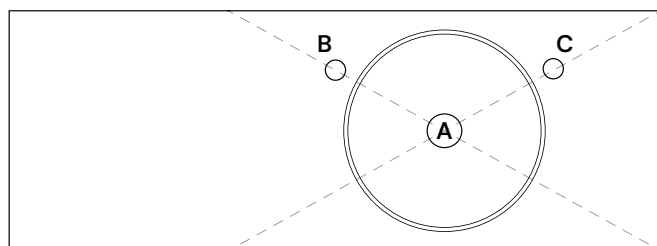

## SCHEMA 4 (SCH402)

Fori lavabi "A" centrati su base con cassetto doppio  
 Holes for basins "A" centered on the base with double drawer

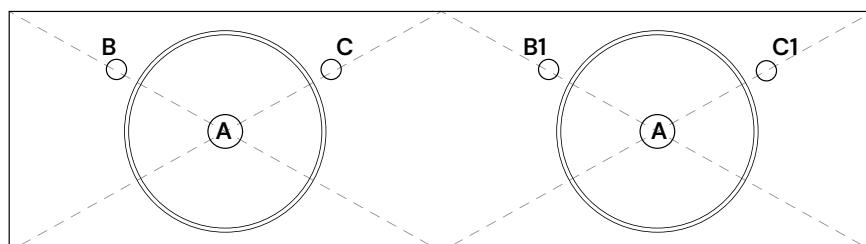

# RELAX STYLES

## WOOD EFFECT\*



noce chiaro



noce scuro

\*Disponibili solo per l'anta  
 Available for the door of the base only

## MATT AND GLOSSY COLORS



bianco



perla



nebbia



seta



pietra



germoglio



nero



talpa



cemento



felce



canapa



visone



bordeaux



cacao



celadon



iuta



fumo di Londra



grafite



ceruleo



petrolio



rosa antico



bruma



cotto



fango

## STRUCTURE



bianco matt / matt white  
 RAL 9016

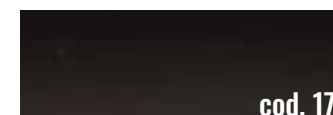

nero matt / matt black  
 RAL 9005

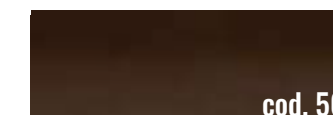

moka / moka  
 RAL 8014

# RELAX OVERVIEW

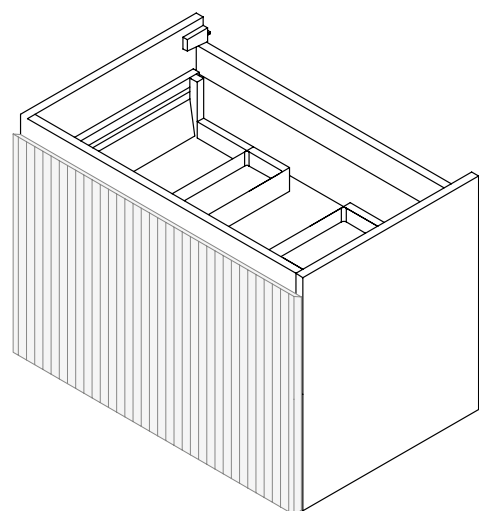

## RELAX | p. 46

base con cassetto

base with drawer



schede tecniche  
technical drawing

codice	largh.	colore	euro
MATT COLORS			
ACM260	60	M	650
ACM270	70	M	670
ACM280	80	M	670
ACM290	90	M	670
GLOSSY COLORS			
ACM260	60	L	820
ACM270	70	L	830
ACM280	80	L	850
ACM290	90	L	860

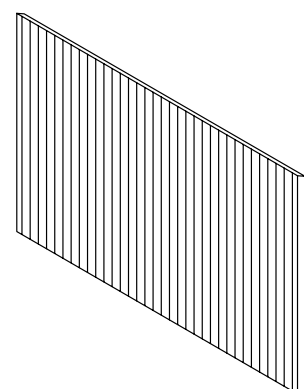

## RELAX | p. 46

anta per base  
con cassetto

door for base with drawer



schede tecniche  
technical drawing

codice	largh.	colore	euro
WOOD EFFECT			
ACM160	60		190
ACM170	70		200
ACM180	80		205
ACM190	90		210
MATT COLORS			
ACM160	60	M	190
ACM170	70	M	200
ACM180	80	M	205
ACM190	90	M	210
GLOSSY COLORS			
ACM160	60	L	200
ACM170	70	L	210
ACM180	80	L	215
ACM190	90	L	220

# RELAX OVERVIEW

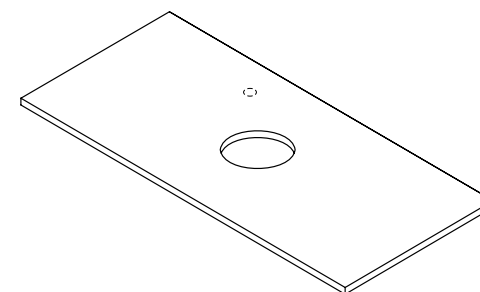

## TOP | p. 46

top laccato senza foro

laquered top without hole

codice	largh.	colore	euro
MATT COLORS			
ACA100	M		250*
GLOSSY COLORS			
ACA100	L		290*

Foro lavabo "A" senza rubinetto

Hole basin "A" without taphole

codice	colore	euro
SCH101	00	80
SCH201	00	80
SCH301	00	80
SCH402	00	80

Schema 1 Foro "A" top Relax  
con foro rubinetto

Diagram 1 Hole "A" top Relax  
with taphole

codice	colore	euro
SCH101	01 Foro B/Hole B	80
SCH101	02 Foro C/Hole C	80

Schema 2 Foro "A" top Relax  
con foro rubinetto

Diagram 2 Hole "A" top Relax  
with taphole

codice	colore	euro
SCH201	01 Foro B/Hole B	80
SCH201	02 Foro C/Hole C	80

Schema 3 Foro "A" top Relax  
con foro rubinetto

Diagram 3 Hole "A" top Relax  
with taphole

codice	colore	euro
SCH301	01 Foro B/Hole B	80
SCH301	02 Foro C/Hole C	80

Schema 4 Fori "A" top Relax  
con fori rubinetti

Diagram 4 Holes "A" top Relax  
with tapholes

codice	colore	euro
SCH402	01 Foro B/Hole B	80
SCH402	02 Foro C/Hole C	80
SCH402	03 Foro B1/Hole B1	80
SCH402	04 Foro C1/Hole C1	80

Per schemi posizionamento fori andare a pag 142  
For hole positioning diagrams go to page 142

\*Calcolo prezzo: (base cassetto + base a giorno)\*prezzo finitura  
Price calculation: (base with drawer + open base)\*finishing price

# RELAX OVERVIEW

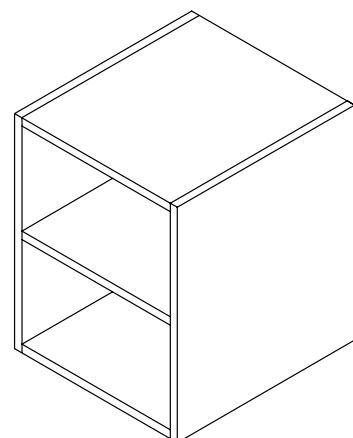

## RELAX | p. 46

base a giorno

*open base*

codice	largh.	colore	euro
MATT COLORS			
ACM125	25	M	545
ACM130	30	M	550
ACM135	35	M	555
ACM140	40	M	560
ACM145	45	M	570
ACM150	50	M	575
GLOSSY COLORS			
ACM125	25	L	680
ACM130	30	L	690
ACM135	35	L	695
ACM140	40	L	710
ACM145	45	L	720
ACM150	50	L	730

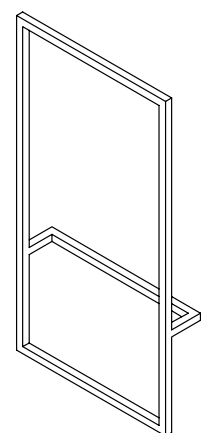

## RELAX

accessorio mobile in metallo  
dx/sx

*metal accessory for furniture rh/lh*

codice	largh.	colore	euro
STRUCTURE			
ACA101			400

# RELAX OVERVIEW

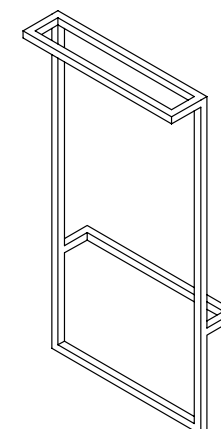

## RELAX

accessorio mobile in metallo  
con portasciugamani dx/sx

*metal accessory for  
furniture with towelholder  
rh/lh*

codice	largh.	colore	euro
STRUCTURE			
ACA102			450

# CHU RCH



Scopri online  
Discover it online

Collezione di strutture  
a 3 e 4 tubi in metallo  
per lavabi d'appoggio

Collection of 3 and 4 pipe  
metal structures  
for countertop washbasins



## STRUCTURES COLLECTION

Functional Harmony.  
Church is a small piece of architecture for the bathroom.  
A structure, a collage of pipes defining the space beneath  
countertop washbasins, giving it character and identity.  
Three or four metal pipes evoke the image of a church organ,  
which inspired the evocative name.

# Armonia funzionale.

Church è una piccola opera  
d'architettura per il bagno.  
Una struttura, un collage di tubi che  
definiscono lo spazio sotto i lavabi  
da appoggio, conferendogli carattere  
e identità. Tre o quattro canne  
metalliche riportano iconicamente  
alla mente l'organo, da cui nasce  
il nome evocativo.

ACA085 | Ø 39 h 71  
Struttura 3 tubi in metallo  
per lavabi appoggio  
3-pipe metal structure  
for countertop washbasins  
moka



**ACA085 | Ø 39 h 71**

Struttura 3 tubi in metallo  
per lavabi appoggio  
*3-pipe metal structure  
for countertop washbasins  
moka*



**ACA085 | Ø 39 h 71**

Struttura 3 tubi in metallo  
per lavabi appoggio  
*3-pipe metal structure  
for countertop washbasins  
nero matt / matt black*

Its towel rail becomes an integral part of the structure, an iconic detail that encircles and connects the pipes supporting the washbasin. A functional feature that turns into a distinctive design sign.

L'elemento portasalviette diventa parte integrante della struttura, un segno distintivo che abbraccia e unisce le canne metalliche di supporto al lavabo. Un dettaglio funzionale che si trasforma in tratto iconico.

**ACA086 | 34 x 53 h 71**

Struttura 4 tubi in metallo  
per lavabi appoggio  
*4-pipe metal structure  
for countertop washbasins*  
nero matt / matt black



# CHURCH 3 SYSTEM

La struttura metallica a 3 canne Church è coordinabile ai lavabi della produzione Artceram.  
I lavabi vengono così "sorretti ed elevati" a dei veri e propri centrostanza!

*The structure with 3 metal pipes Church on which basins made by Artceram can be mounted.  
The washbasins are "supported and raised" to real centerpieces!*

**BRERA (BRL001)**  
lavabo appoggio  
countertop washbasin  
Ø43

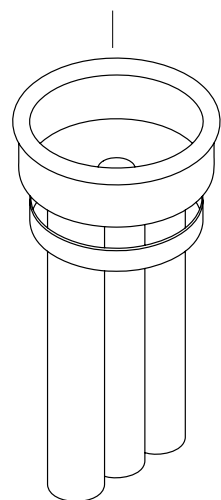

**COGNAC 42 (COL001)**  
lavabo appoggio  
countertop washbasin  
Ø42

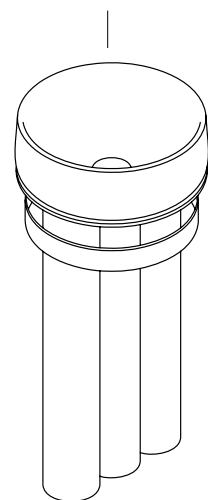

**COGNAC 35 (COL004)**  
lavabo appoggio  
countertop washbasin  
Ø35

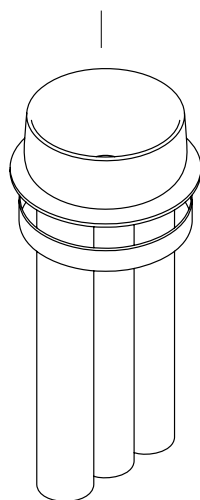

**COGNAC 48 (COL002)**  
lavabo appoggio  
countertop washbasin  
Ø48

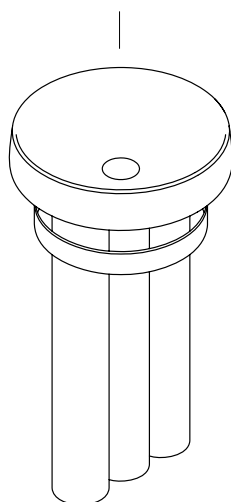

**ROMBO (OSL009)**  
lavabo appoggio  
countertop washbasin  
Ø44

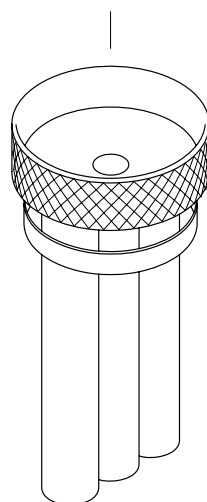

**MILLERIGHE (OSL010)**  
lavabo appoggio  
countertop washbasin  
Ø44

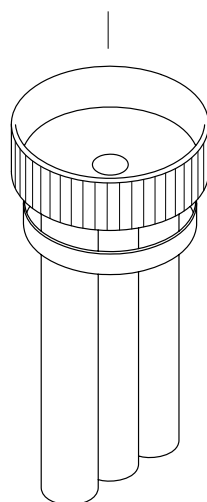

**WON 44 (WNL002)**  
lavabo appoggio  
countertop washbasin  
Ø44

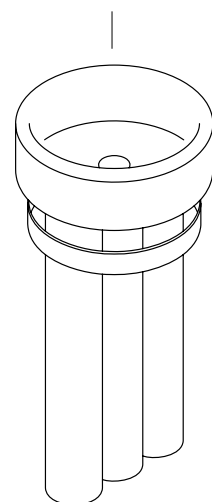

Per le specifiche dei lavabi consigliati andare a pag. 410  
All the specifications of the recommended washbasins at page 410

# CHURCH 4 SYSTEM

La gamma di lavabi disponibili sulla struttura a 4 canne è più ridotta rispetto a quella precedente,  
ma non è meno iconica nella sua estetica finale!

*The range of washbasins available on the 4 metal pipes structure is smaller than the previous one,  
but it's no less iconic in its final aesthetic!*

**BRERA (BRL003)**  
lavabo appoggio  
countertop washbasin  
60x40

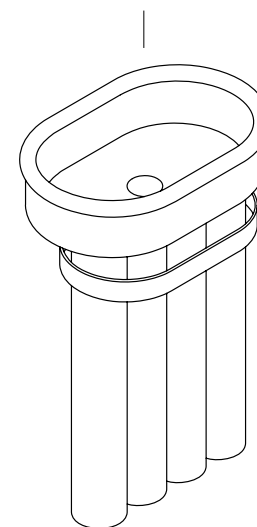

**COGNAC 55 (COL003)**  
lavabo appoggio  
countertop washbasin  
55x35

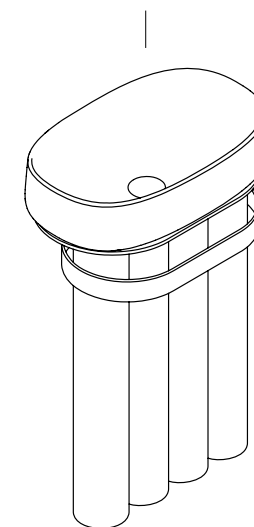

**WON 55 (WNL001)**  
lavabo appoggio  
countertop washbasin  
55x37

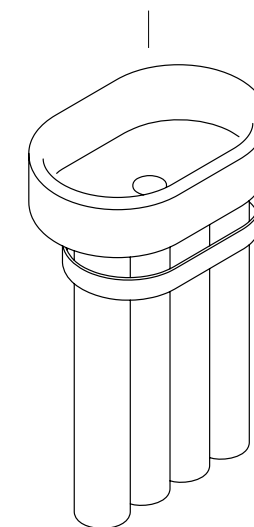

Per le specifiche dei lavabi consigliati andare a pag. 410  
All the specifications of the recommended washbasins at page 410

**ACA086 | 34 x 53 h 71**

Struttura 4 tubi in metallo  
per lavabi appoggio  
*4-pipe metal structure  
for countertop washbasins*  
bianco matt / *matt white*



# CHURCH STYLES

## STRUCTURE



cod. 05  
bianco matt / *matt white*  
RAL 9016



cod. 17  
nero matt / *matt black*  
RAL 9005



cod. 56  
moka / *moka*  
RAL 8014

## CHURCH OVERVIEW



### CHURCH 3 | Ø 39 h 71

struttura 3 tubi metallo  
per lavabi appoggio con piletta  
cromo filettata inclusa  
nel prezzo

*3-pipe metal structure  
for countertop washbasins  
with threaded chrome  
drain included in the price*



schede tecniche  
technical drawing



### CHURCH 4 | 34 x 53 h 71

struttura 4 tubi metallo  
per lavabi appoggio con piletta  
cromo filettata inclusa  
nel prezzo

*4-pipe metal structure  
for countertop washbasins  
with threaded chrome  
drain included in the price*



schede tecniche  
technical drawing

codice	colore	kg	pz. pallet Italia	pz. pallet Export	euro
STRUCTURE <b>ACA085</b>		21	-	-	1700

codice	colore	kg	pz. pallet Italia	pz. pallet Export	euro
STRUCTURE <b>ACA086</b>		27	-	-	1995

# SANITARY WARE

SANITARI  
THE.ARTCERAM

SOLIDA (P.162)

SETA (P.180)

A16 (P.200)

VITA (P.222)

ATELIER (P.242)

FILE 2.0 (P.266)

MONET (P.284)

HYPE (P.306)

CIVITAS (P.322)

HERMITAGE (P.350)

TEN (P.376)

# SOLI DA



Scopri online  
Discover it online

Collezione di sanitari sospesi  
scarico The.Reel

Wall-hung The.Reel  
sanitaryware collection



# SANITARYWARE COLLECTION

Essence takes shape.  
Solida is the new collection of wall-hung sanitaryware that interprets the contemporary bathroom with a refined balance between structured geometry and visual softness. Sharp, precise lines meet rounded, lightweight volumes, creating an essential aesthetic that conveys visual and tactile comfort at first glance. Designed for quiet, carefully curated spaces, Solida expresses a pure design in which every detail contributes to an overall harmony of proportions, surfaces, and lightness.

# L'essenza prende forma.

Solida è la nuova collezione di sanitari sospesi che interpreta il bagno contemporaneo con un equilibrio raffinato tra geometria strutturata e morbidezza visiva. Linee nette e precise incontrano volumi arrotondati e leggeri, dando vita a un'estetica essenziale che trasmette comfort visivo e tattile sin dal primo sguardo. Pensata per spazi silenziosi e curati, Solida esprime un design essenziale in cui ogni dettaglio contribuisce a creare un'armonia fatta di proporzioni, superfici e leggerezza.

SOV001 + FLA016 | 36 x 53

Vaso sospeso The.Reel  
Wall-hung The.Reel WC

SOB001 | 36 x 53

Bidet sospeso  
Wall-hung bidet



**SOV001 + FLA016 | 36 x 53**

Vaso sospeso The.Reel  
Wall-hung The.Reel WC

**SOB001 | 36 x 53**

Bidet sospeso  
Wall-hung bidet



The wall-hung WC stands out with a strong yet harmonious presence, featuring compact, continuous shapes made even more distinctive. The bidet combines soft yet defined surfaces, both inside the bowl and in its external geometry, achieving a carefully balanced harmony between function and elegance.

Il vaso sospeso si distingue per una presenza decisa ma armoniosa, con forme compatte e continue, ancora più riconoscibili. Il bidet combina superfici morbide e definite, sia all'interno del catino sia nelle geometrie esterne, in un equilibrio calibrato tra funzione ed eleganza.



**SOV001 + FLA016 | 36 x 53**  
Vaso sospeso The.Reel  
*Wall-hung The.Reel WC*

**SOB001 | 36 x 53**  
Bidet sospeso  
*Wall-hung bidet*



Solida è proposta nell'ampia palette cromatica di Artceram: finiture lucide e opache, colori attuali e materici, capaci di valorizzare ogni ambiente bagno con naturalezza e un'eleganza silenziosa, senza tempo.

A destra / On the right:

**SOV001 + FLA016 | 36 x 53**

Vaso sospeso The.Reel  
Wall-hung The.Reel WC  
paprika

**SOB001 | 36 x 53**

Bidet sospeso  
Wall-hung bidet  
paprika



Solida is available in Artceram's wide colour palette, featuring glossy and matt finishes in contemporary, tactile shades that enhance any bathroom with natural, timeless, and quiet elegance.





**SOV001 + FLA016 | 36 x 53**  
Vaso sospeso The.Reel  
Wall-hung The.Reel WC  
paprika

**SOB001 | 36 x 53**  
Bidet sospeso  
Wall-hung bidet  
paprika



SOV001 + FLA016 | 36 x 53

Vaso sospeso The.Reel  
Wall-hung The.Reel WC

SOB001 | 36 x 53

Bidet sospeso  
Wall-hung bidet



## SOLIDA COLLECTION DNA

Scopri le caratteristiche tecniche principali della collezione Solida  
Discover the main technical features of the Solida collection

### THE.REEL

Sistema di scarico a vortice universale: può essere installato sia su cassette standard 6/3 L, sia su cassette a risparmio idrico 4/2 L, garantendo sempre un risciacquo potente, uniforme e silenzioso.

*Universal vortex flush system: can be installed on both standard 6/3 L cisterns and water-saving 4/2 L models, while always ensuring a powerful, even and quiet flush.*



### THE.SANIGLAZE

Trattamento antibatterico ed easy-to-clean integrato nella ceramica: gli ioni attivi rendono la superficie più liscia, idrofila, brillante e resistente, con protezione certificata.

*Antibacterial, easy-to-clean treatment built into the ceramic: active ions make the surface smoother, hydrophilic, shinier, and more durable, with certified protection.*



**-99,98%  
BACTERIA**



# SOLIDA STYLES

## CLASSIC COLORS



bianco lucido / glossy white



bianco matt / matt white



nero matt / matt black

## MATT COLORS



marrone matra / brown matra



sabbia / sand



ghiaia / gravel

## GLOSSY COLORS



curcuma / turmeric



paprika / paprika



edera / ivy



zefiro / zephyr

# SOLIDA OVERVIEW



THE REEL

THE SANIGLAZE

## SOLIDA | 36 x 53

vaso sospeso con nuovo scarico universale a vortice, con Saniglaze

wall-hung wc with new universal whirl-flush, with Saniglaze



schede tecniche  
technical drawing

codice	colore	kg	pz. pallet Italia	pz. pallet Export	euro
--------	--------	----	-------------------	-------------------	------

### CLASSIC COLORS

SOV001	○ 01; 00	22,5	12	20	480
SOV001	◎ 05; 00	22,5	12	20	670
SOV001	● 17; 00	22,5	12	20	670

### MATT COLORS

SOV001		00	22,5	12	20	670
--------	--	----	------	----	----	-----

### GLOSSY COLORS

SOV001		00	22,5	12	20	670
--------	--	----	------	----	----	-----

\* kit fissaggio per sanitari sospesi obbligatorio, non incluso con il sanitario

mandatory fitting system kit for wall-hung sanitaryware, not included with the sanitaryware

ACA052		0,3	-	-	25
--------	--	-----	---	---	----



THE SANIGLAZE

## SOLIDA | 36 x 53

bidet sospeso 1 foro, con Saniglaze

wall-hung bidet 1 hole, with Saniglaze



schede tecniche  
technical drawing

### CLASSIC COLORS

SOB001	○ 01; 00	19,5	12	20	480
SOB001	◎ 05; 00	19,5	12	20	670
SOB001	● 17; 00	19,5	12	20	670

### MATT COLORS

SOB001		00	19,5	12	20	670
--------	--	----	------	----	----	-----

### GLOSSY COLORS

SOB001		00	19,5	12	20	670
--------	--	----	------	----	----	-----

\* kit fissaggio per sanitari sospesi obbligatorio, non incluso con il sanitario

mandatory fitting system kit for wall-hung sanitaryware, not included with the sanitaryware

ACA052		0,3	-	-	25
--------	--	-----	---	---	----

\*

Il tappo del troppopieno è coordinato al colore della ceramica, ad eccezione della versione in ceramica bianca lucida, abbinata a tappo cromo.

\*

The overflow cover is matched to the ceramic color, except for the glossy white ceramic version, which is paired with a chrome cover.

# SOLIDA OVERVIEW



## VITA/SOLIDA

seduta Flat avvolgente  
per WC frizionata a sgancio  
rapido

*easy take off soft-close  
enveloping Flat WC seat*

codice	colore	kg	pz. pallet Italia	pz. pallet Export	euro
CLASSIC COLORS					
FLA018	○ 01	3	-	-	185
FLA018	◎ 05	3	-	-	280
FLA018	● 17	3	-	-	280
MATT COLORS					
FLA018		3	-	-	280
GLOSSY COLORS					
FLA018		3	-	-	280



## VITA/SOLIDA

seduta Flat per WC frizionata  
a sgancio rapido

*easy take off soft-close  
Flat WC seat*

codice	colore	kg	pz. pallet Italia	pz. pallet Export	euro
CLASSIC COLORS					
FLA016	○ 01; 71	3	-	-	185
FLA016	◎ 05; 71	3	-	-	280
FLA016	● 17; 71	3	-	-	280
MATT COLORS					
FLA016		3	-	-	280
GLOSSY COLORS					
FLA016		3	-	-	280



## VITA/SOLIDA

seduta Flat per WC frizionata  
a sgancio rapido Magiclight

*easy take off soft-close  
Magiclight Flat WC seat*

FLA016	○ 01; 20	3,5	-	-	295
--------	----------	-----	---	---	-----

# SOLIDA ACCESSORIES

piletta universale  
up & down cromo

*chrome up & down drain*



piletta universale up & down  
con tappo in ceramica,  
con Saniglaze

*up & down universal drain with  
ceramic cover for washbasins,  
with Saniglaze*

codice	colore	kg	pz. pallet Italia	pz. pallet Export	euro
ACA032		0,3	-	-	75
CLASSIC COLORS					
ACA036	○ 01; 34	0,3	-	-	80
ACA038	◎ 05; 34	0,3	-	-	90
ACA038	● 17; 34	0,3	-	-	90
MATT COLORS					
ACA038		34	0,3	-	90
GLOSSY COLORS					
ACA038		34	0,3	-	90

sifone ridotto - *reduced siphon*

staffe di fissaggio per sospesi  
*fitting system kit for wall-hung*

protezione adesiva antirumore  
zig/zag  
*soundproof zig/zag*

ACA021		1	-	-	100
ACA016		4	-	-	70
ACA104		0,3	-	-	15

# SETA



Scopri online  
Discover it online

Collezione di sanitari a terra  
filomuro e sospesi scarico  
The.Reel

Wall-hung and back to wall  
The.Reel sanitaryware collection



# SANITARYWARE COLLECTION

Fluid forms, essential elegance.  
The new Seta ceramic sanitaryware collection brings delicacy and fluidity to the bathroom. It is best represented by the image of a silk scarf moved by the wind: soft shapes that flow naturally and harmoniously through space, far from the rigidity of straight lines. A collection designed to inspire elegant, relaxing spaces.

# Forme fluide, eleganza essenziale.

La nuova collezione di ceramica sanitaria Seta porta nel bagno delicatezza e fluidità. L'immagine che la rappresenta al meglio è quella di un foulard di seta mosso dal vento: forme morbide che si muovono nello spazio con naturalezza e armonia, lontane dalla rigidità delle linee rette. Una collezione che vuole ispirare ambienti eleganti e rilassanti.



**SEV001 + SEA001 | 36 x 53**

Vaso sospeso con nuovo scarico universale a vortice  
*Wall-hung wc with new universal whirl-flush*  
edera/ivy

**SEB001 | 36 x 53**

Bidet sospeso  
*Wall-hung bidet*  
edera/ivy



Each piece reflects meticulous design work, with lines that balance a slightly more linear front with gently rounded sides, creating an elegant, dynamic profile. The wall-hung sanitaryware stands out for its generous dimensions and pure, balanced forms, while the wraparound seat cover, with its minimal thickness, offers surprising visual lightness. The floor-standing pieces, sharing the same harmony, complete the collection with versatile, refined solutions.

Ogni sanitario riflette un accurato lavoro di design, con linee che bilanciano una parte anteriore leggermente più lineare con un raccordo laterale tondeggiante, definendo un profilo elegante e dinamico. I sanitari sospesi si distinguono per dimensioni generose e purezza formale, con un copriwater avvolgente dal minimo spessore per una sorprendente leggerezza visiva. I pezzi a terra, con la stessa armonia, completano la collezione con soluzioni versatili e raffinate.

**SEV001 + SEA001 | 36 x 53**

Vaso sospeso con nuovo  
scarico universale a vortice  
*Wall-hung wc with new  
universal whirl-flush  
edera/ivy*

**SEB001 | 36 x 53**

Bidet sospeso  
*Wall-hung bidet  
edera/ivy*



**SEV002 + SEA001 | 36 x 54**

Vaso terra filomuro traslato  
con nuovo scarico vortice universale  
*Back to wall wc with new universal  
adjustable whirl-flush*





**SEV002 + SEA001 | 36 x 54**

Vaso terra filomuro traslato  
con nuovo scarico vortice universale  
*Back to wall wc with new universal  
adjustable whirl-flush*

**SEB002 | 36 x 54**

Bidet terra filomuro  
*Back to wall bidet*



A destra / On the right:

**SEV002 + SEA001 | 36 x 54**

Vaso terra filomuro traslato  
con nuovo scarico vortice  
universale

*Back to wall wc with new  
universal adjustable  
whirl-flush*

**SEB002 | 36 x 54**

Bidet terra filomuro  
*Back to wall bidet*



# SETA COLLECTION DNA

Scopri le caratteristiche tecniche principali della collezione Seta  
Discover the main technical features of the Seta collection

## THE REEL

Sistema di scarico a vortice universale: può essere installato sia su cassette standard 6/3 L, sia su cassette a risparmio idrico 4/2 L, garantendo sempre un risciacquo potente, uniforme e silenzioso.

*Universal vortex flush system: can be installed on both standard 6/3 L cisterns and water-saving 4/2 L models, while always ensuring a powerful, even and quiet flush.*



## THE SANIGLAZE

Trattamento antibatterico ed easy-to-clean integrato nella ceramica: gli ioni attivi rendono la superficie più liscia, idrofila, brillante e resistente, con protezione certificata.

*Antibacterial, easy-to-clean treatment built into the ceramic: active ions make the surface smoother, hydrophilic, shinier, and more durable, with certified protection.*



## SCARICO TRASLATO

Il vaso filomuro dispone di scarico traslato. Le connessioni di scarico sono regolabili grazie agli abbinamenti delle curve con i manicotti (concentrico od eccentrici) - da acquistare separatamente.

*The back to wall WC has an adjustable flush. Drainage connections can be adjust thanks to the combinations of the curves with the pipes (concentric or eccentric) - to be purchased separately.*

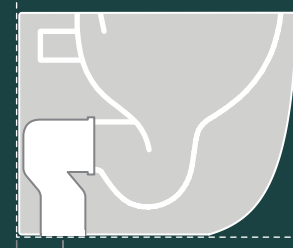

**ACA005 + ACA076** > 10 CM  
**ACA005 + ACA077** > 8/10 CM  
**ACA005 + ACA078** > 14 CM  
CURVA TECNICA S + MANICOTTO DI SCARICO A PAVIMENTO ELBOW AT FLOOR S + ARRANGEMENT DISCHARGE TO FLOOR

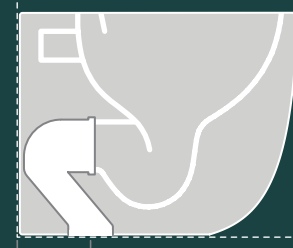

**ACA074 + ACA076** > 15 CM  
**ACA074 + ACA077** > 13/17 CM  
CURVA TECNICA TRASLATA + MANICOTTO DI SCARICO A PAVIMENTO ADJUSTABLE PIPE + ARRANGEMENT DISCHARGE TO FLOOR

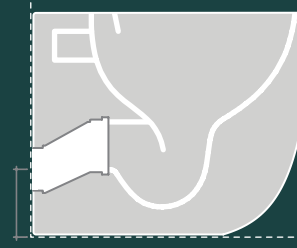

**ACA075**  
RACCORDO DI SCARICO A PARETE TRASLATO H 18 CM WALL TRAP ADJUSTABLE PIPE H 18 CM

## HIDDEN FIXING SYSTEM

Sistema di fissaggio nascosto: installazione pulita ed essenziale, senza elementi visibili. Garantisce montaggio semplice, stabile e preciso, con estetica impeccabile.

*Hidden fixing system: clean, minimal installation with no visible elements. Ensures easy, stable and precise mounting while preserving flawless design.*

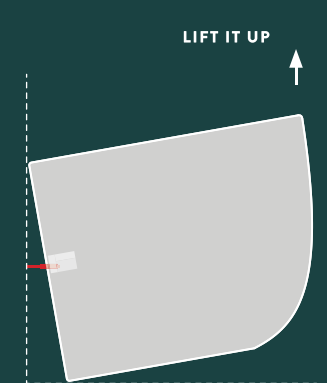
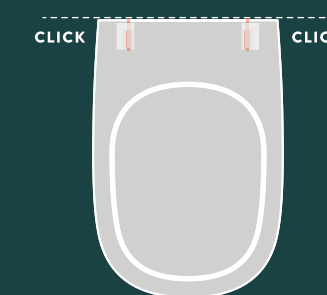
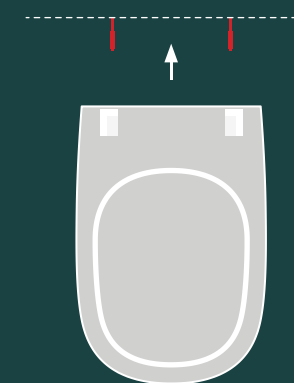

# SETA STYLES

## CLASSIC COLORS



cod. 01  
bianco lucido / glossy white



cod. 05  
bianco matt / matt white



cod. 17  
nero matt / matt black

## MATT COLORS



cod. 41  
marrone matera / brown matera



cod. 59  
sabbia / sand



cod. 60  
ghiaia / gravel

## GLOSSY COLORS



cod. 67  
curcuma / turmeric



cod. 68  
paprika / paprika



cod. 69  
edera / ivy



cod. 70  
zefiro / zephyr

# SETA OVERVIEW



THE REEL

THE SANIGLAZE

## SETA | 36 x 53

vaso sospeso con nuovo scarico universale a vortice, con Saniglaze

wall-hung wc with new universal whirl-flush, with Saniglaze



schede tecniche  
technical drawing

codice	colore	kg	pz. pallet Italia	pz. pallet Export	euro
--------	--------	----	-------------------	-------------------	------

### CLASSIC COLORS

SEV001	○ 01	34	24,5	12	20	450
--------	------	----	------	----	----	-----

SEV001	◎ 05	34	24,5	12	20	630
--------	------	----	------	----	----	-----

SEV001	● 17	34	24,5	12	20	630
--------	------	----	------	----	----	-----

### MATT COLORS

SEV001		34	24,5	12	20	630
--------	--	----	------	----	----	-----

### GLOSSY COLORS

SEV001		34	24,5	12	20	630
--------	--	----	------	----	----	-----

\* kit fissaggio per sanitari sospesi obbligatorio, non incluso con il sanitario

mandatory fitting system kit for wall-hung sanitaryware, not included with the sanitaryware

ACA052		0,3	-	-	-	25
--------	--	-----	---	---	---	----

THE SANIGLAZE



## SETA | 36 x 53

bidet sospeso 1 foro, con Saniglaze

wall-hung bidet 1 hole, with Saniglaze



schede tecniche  
technical drawing

### CLASSIC COLORS

SEB001	○ 01	34	21	12	20	450
--------	------	----	----	----	----	-----

SEB001	◎ 05	34	21	12	20	630
--------	------	----	----	----	----	-----

SEB001	● 17	34	21	12	20	630
--------	------	----	----	----	----	-----

### MATT COLORS

SEB001		34	21	12	20	630
--------	--	----	----	----	----	-----

### GLOSSY COLORS

SEB001		34	21	12	20	630
--------	--	----	----	----	----	-----

\* kit fissaggio per sanitari sospesi obbligatorio, non incluso con il sanitario

mandatory fitting system kit for wall-hung sanitaryware, not included with the sanitaryware

ACA052		0,3	-	-	-	25
--------	--	-----	---	---	---	----

\*

Il tappo del troppopieno è coordinato al colore della ceramica, ad eccezione della versione in ceramica bianca lucida, abbinata a tappo cromo.

\*

The overflow cover is matched to the ceramic color, except for the glossy white ceramic version, which is paired with a chrome cover.

# SETA OVERVIEW



THE REEL

THE SANIGLAZE

SCARICO TRASLATO

## SETA | 36 x 54

vaso terra filomuro traslato con nuovo scarico vortice universale, con Saniglaze

back to wall wc with new universal adjustable whirl-flush, with Saniglaze



schede tecniche  
technical drawing

codice	colore	kg	pz. pallet Italia	pz. pallet Export	euro	
CLASSIC COLORS						
SEV002	○ 01; 00	28	10	15	450	
SEV002	◎ 05; 00	28	10	15	630	
SEV002	● 17; 00	28	10	15	630	
MATT COLORS						
SEV002		00	28	10	15	630
GLOSSY COLORS						
SEV002		00	28	10	15	630

\* kit fissaggio nascosto per sanitari filomuro obbligatorio, non incluso con il sanitario

mandatory hidden fitting system kit for back to wall sanitaryware, not included with the sanitaryware

ACA039		0,3	-	-	25
--------	--	-----	---	---	----



THE SANIGLAZE

## SETA | 36 x 54

bidet terra filomuro 1 foro, con Saniglaze

back to wall bidet 1 hole, with Saniglaze



schede tecniche  
technical drawing

codice	colore	kg	pz. pallet Italia	pz. pallet Export	euro	
CLASSIC COLORS						
SEB002	○ 01; 00	25	10	15	450	
SEB002	◎ 05; 00	25	10	15	630	
SEB002	● 17; 00	25	10	15	630	
MATT COLORS						
SEB002		00	25	10	15	630
GLOSSY COLORS						
SEB002		00	25	10	15	630

\* kit fissaggio nascosto per sanitari filomuro obbligatorio, non incluso con il sanitario

mandatory hidden fitting system kit for back to wall sanitaryware, not included with the sanitaryware

ACA039		0,3	-	-	25
--------	--	-----	---	---	----

# SETA OVERVIEW



## SETA

seduta per WC frizionata a sgancio rapido

easy take off soft-close WC seat

codice	colore	kg	pz. pallet Italia	pz. pallet Export	euro	
CLASSIC COLORS						
SEA001	○ 01; 71	3	-	-	185	
SEA001	◎ 05; 71	3	-	-	280	
SEA001	● 17; 71	3	-	-	280	
MATT COLORS						
SEA001		71	3	-	-	280
GLOSSY COLORS						
SEA001		71	3	-	-	280



## SETA

seduta per WC frizionata a sgancio rapido Magiclight

easy take off soft-close Magiclight WC seat

SEA001	○ 01; 20	3,5	-	-	295
--------	----------	-----	---	---	-----

# SETA ACCESSORIES

	codice	colore	kg	pz. pallet Italia	pz. pallet Export	euro
piletta universale up & down cromo  <i>chrome up &amp; down drain</i>	<b>ACA032</b>		0,3	-	-	<b>75</b>
 <p>piletta universale up &amp; down con tappo in ceramica, con Saniglaze  <i>up &amp; down universal drain with ceramic cover for washbasins, with Saniglaze</i></p>	CLASSIC COLORS					
	<b>ACA036</b>	○ 01; 34	0,3	-	-	<b>80</b>
	<b>ACA038</b>	◎ 05; 34	0,3	-	-	<b>90</b>
	<b>ACA038</b>	● 17; 34	0,3	-	-	<b>90</b>
	MATT COLORS					
	<b>ACA038</b>		34	0,3	-	-
GLOSSY COLORS						
<b>ACA038</b>		34	0,3	-	-	<b>90</b>
sifone ridotto - <i>reduced siphon</i>	<b>ACA021</b>		1	-	-	<b>100</b>
staffe di fissaggio per sospesi <i>fitting system kit for wall-hung</i>	<b>ACA016</b>		4	-	-	<b>70</b>
riduttore di flusso di scarico per WC <i>plug for reducing water flow</i>	<b>ACA064</b>		4	-	-	<b>15</b>
curva tecnica traslata <i>adjustable pipe</i>	<b>ACA074</b>		0,3	-	-	<b>40</b>
curva tecnica S <i>elbow at floor S</i>	<b>ACA005</b>		0,3	-	-	<b>25</b>

# SETA ACCESSORIES

	codice	colore	kg	pz. pallet Italia	pz. pallet Export	euro
manicotto concentrico <i>concentric pipe</i>	<b>ACA076</b>		0,3	-	-	<b>20</b>
manicotto eccentrico 2 cm <i>eccentric pipe 2 cm</i>	<b>ACA077</b>		0,3	-	-	<b>20</b>
manicotto eccentrico 4 cm <i>eccentric pipe 4 cm</i>	<b>ACA078</b>		0,3	-	-	<b>25</b>
raccordo scarico parete "P" traslato <i>"P" trap adjustable pipe</i>	<b>ACA075</b>		0,3	-	-	<b>25</b>
protezione adesiva antirumore zig/zag <i>soundproof zig/zag</i>	<b>ACA104</b>		0,3	-	-	<b>15</b>

# A16



Scopri la online  
Discover it online

Collezione di sanitari a terra  
filomuro e sospesi scarico  
The.Reel; con variante MINI  
sospesa rimless

Wall-hung and back to wall  
The.Reel sanitaryware  
collection; with the MINI  
rimless wall-hung version



# SANITARYWARE COLLECTION

Designed to last.  
A16 is a technical and contemporary collection designed for those seeking formal precision and advanced functionality. Its slightly squared and controlled geometries create an essential language where straight lines and measured curves coexist, shaping clean, versatile volumes suited to any modern bathroom.

# Progettato per restare.

A16 è una collezione tecnica e contemporanea, pensata per chi cerca precisione formale e funzionalità evoluta. Le sue geometrie leggermente squadrate e controllate creano un linguaggio essenziale, dove linee rette e curve misurate convivono in equilibrio dando vita a volumi puliti e versatili, adatti a qualsiasi bagno moderno.

**ASV007 + ASA001 | 36 x 52**  
Vaso terra filomuro traslato  
con nuovo scarico vortice universale  
*Back to wall wc with new universal  
adjustable whirl-flush*

**ASB005 | 36 x 52**  
Bidet terra filomuro  
*Back to wall bidet*



**ASV007 + ASA001 | 36 x 52**

Vaso terra filomuro traslato  
con nuovo scarico vortice universale  
*Back to wall wc with new universal  
adjustable whirl-flush*

**ASB005 | 36 x 52**

Bidet terra filomuro  
*Back to wall bidet*



Designed for high performance, A16 incorporates Artceram's latest innovations: from the powerful, silent, universal The.Reel flush system to the antibacterial The.Saniglaze treatment, which enhances brilliance, hygiene, and ceramic durability. The back-to-wall version also offers an adjustable flush, ensuring maximum installation flexibility and easy adaptation to different configurations.

Progettata per alte prestazioni, A16 integra le più recenti innovazioni Artceram: dal sistema di scarico The.Reel, potente, silenzioso e universale, al trattamento antibatterico The.Saniglaze, che migliora brillantezza, igiene e durata della ceramica. Nella versione a terra filomuro è disponibile lo scarico traslato, che offre massima flessibilità d'installazione, adattandosi alle diverse configurazioni.

**ASV007 + ASA001 | 36 x 52**

Vaso terra filomuro traslato  
con nuovo scarico vortice universale  
*Back to wall wc with new universal  
adjustable whirl-flush*

**ASB005 | 36 x 52**

Bidet terra filomuro  
*Back to wall bidet*

A destra / On the right:

**ASV006 + ASA001 | 36 x 52**

Vaso sospeso con nuovo  
scarico universale a vortice  
*Wall-hung wc with new  
universal whirl-flush  
sabbia / sand*

**ASB004 | 36 x 52**

Bidet sospeso  
*Wall-hung bidet  
sabbia / sand*





**ASV006 + ASA001 | 36 x 52**

Vaso sospeso con nuovo  
scarico universale a vortice  
*Wall-hung wc with new  
universal whirl-flush  
sabbia / sand*



**ASB004 | 36 x 52**

Bidet sospeso  
*Wall-hung bidet  
sabbia / sand*



ASV005 + ASA002 | 36 x 45 (MINI)

Vaso sospeso Senza Brida  
Wall-hung Rimless WC

ASB003 | 36 x 45 (MINI)

Bidet sospeso  
Wall-hung bidet



Alongside the standard models, the range includes A16 MINI, a compact-depth variant ideal for smaller spaces, featuring a rimless flush for more direct cleaning. Essential, precise, and flexible, A16 delivers a balanced blend of aesthetics and performance, suited to many contexts and to bathrooms that value functionality and contemporary style.



Accanto ai modelli standard c'è A16 MINI, una variante più compatta in profondità, ideale per spazi contenuti e dotata di scarico senza brida per una pulizia più diretta. Essenziale, precisa e flessibile, A16 offre una sintesi equilibrata tra estetica e prestazioni, adatta a molteplici contesti e a un bagno funzionale e contemporaneo.

# A16 COLLECTION DNA

Scopri le caratteristiche tecniche principali della collezione A16  
 Discover the main technical features of the A16 collection

## THE REEL

Sistema di scarico a vortice universale: può essere installato sia su cassette standard 6/3 L, sia su cassette a risparmio idrico 4/2 L, garantendo sempre un risciacquo potente, uniforme e silenzioso.

*Universal vortex flush system: can be installed on both standard 6/3 L cisterns and water-saving 4/2 L models, while always ensuring a powerful, even and quiet flush.*



## THE SANIGLAZE

Trattamento antibatterico ed easy-to-clean integrato nella ceramica: gli ioni attivi rendono la superficie più liscia, idrofila, brillante e resistente, con protezione certificata.

*Antibacterial, easy-to-clean treatment built into the ceramic: active ions make the surface smoother, hydrophilic, shinier, and more durable, with certified protection.*



## SCARICO TRASLATO

Il vaso filomuro dispone di scarico traslato. Le connessioni di scarico sono regolabili grazie agli abbinamenti delle curve con i manicotti (concentrico od eccentrici) - da acquistare separatamente.

*The back to wall WC has an adjustable flush. Drainage connections can be adjust thanks to the combinations of the curves with the pipes (concentric or eccentric) - to be purchased separately.*

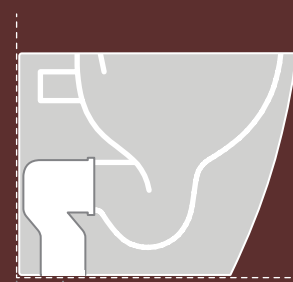

**ACA005 + ACA076** > 10 CM  
**ACA005 + ACA077** > 8/10 CM  
**ACA005 + ACA078** > 14 CM  
 CURVA TECNICA S + MANICOTTO DI SCARICO A PAVIMENTO  
 ELBOW AT FLOOR S + ARRANGEMENT DISCHARGE TO FLOOR

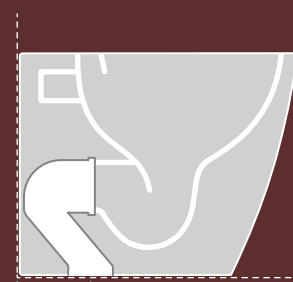

**ACA074 + ACA076** > 15 CM  
**ACA074 + ACA077** > 13/17 CM  
 CURVA TECNICA TRASLATA + MANICOTTO DI SCARICO A PAVIMENTO  
 ADJUSTABLE PIPE + ARRANGEMENT DISCHARGE TO FLOOR

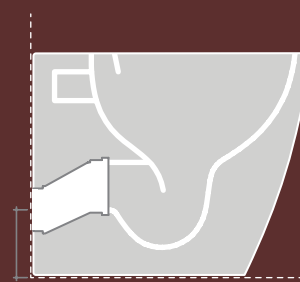

**ACA075**  
 RACCORDO DI SCARICO A PARETE TRASLATO H 18 CM  
 WALL TRAP ADJUSTABLE PIPE H 18 CM

## HIDDEN FIXING SYSTEM

Sistema di fissaggio nascosto: installazione pulita ed essenziale, senza elementi visibili. Garantisce montaggio semplice, stabile e preciso, con estetica impeccabile.

*Hidden fixing system: clean, minimal installation with no visible elements. Ensures easy, stable and precise mounting while preserving flawless design.*

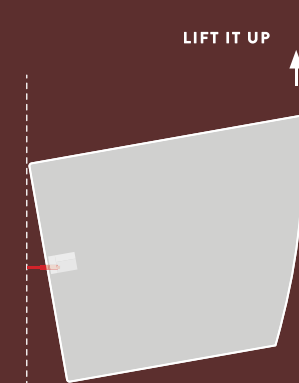
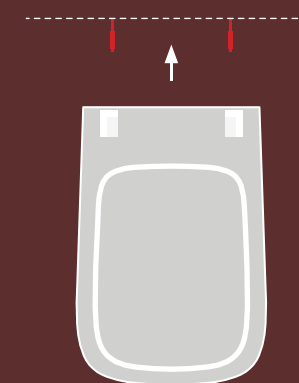

# A16 COLLECTION DNA

Scopri le caratteristiche tecniche principali della collezione A16  
Discover the main technical features of the A16 collection

## DUE DIMENSIONI

La collezione è disponibile in due varianti, A16 e A16 MINI. La versione MINI propone dimensioni più compatte rispetto al modello standard. La profondità si riduce da 52 cm a 45 cm, offrendo una soluzione più snella pensata per ottimizzare lo spazio.

*The collection is available in two versions, A16 and A16 MINI. The MINI version offers more compact dimension. The depth is reduced from 52 cm to 45 cm, providing a slimmer solution designed to optimise space.*



## THE RIMLESS (A16 MINI)

Sistema di scarico senza brida: niente zone nascoste, pulizia più facile e getto uniforme per migliore igiene ed efficienza. Solo su A16 Mini.

*Rimless flush system: no hidden areas, easier cleaning, and an even water flow for better hygiene and efficiency. Only for A16 Mini.*



# A16 STYLES

## CLASSIC COLORS



bianco lucido / glossy white



bianco matt / matt white



nero matt / matt black

## MATT COLORS



marrone matera / brown matera



sabbia / sand



ghiaia / gravel

# A16 OVERVIEW



THE REEL

THE SANIGLAZE

## A16 | 36 x 52

vaso sospeso con nuovo scarico universale a vortice, con Saniglaze

wall-hung wc with new universal whirl-flush, with Saniglaze



schede tecniche  
technical drawing

codice	colore	kg	pz. pallet Italia	pz. pallet Export	euro
CLASSIC COLORS					
ASV006	○ 01; 00	23	12	20	470
ASV006	◎ 05; 00	23	12	20	640
ASV006	● 17; 00	23	12	20	640
MATT COLORS					
ASV006	00	23	12	20	640

\* kit fissaggio per sanitari sospesi obbligatorio, non incluso con il sanitario

ACA052	0,3	-	-	25
--------	-----	---	---	----

mandatory fitting system kit for wall-hung sanitaryware, not included with the sanitaryware



THE SANIGLAZE

## A16 | 36 x 52

bidet sospeso 1 foro, con Saniglaze

wall-hung bidet 1 hole, with Saniglaze



schede tecniche  
technical drawing

codice	colore	kg	pz. pallet Italia	pz. pallet Export	euro
CLASSIC COLORS					
ASB004	○ 01; 00	21	12	20	470
ASB004	◎ 05; 00	21	12	20	640
ASB004	● 17; 00	21	12	20	640
MATT COLORS					
ASB004	00	21	12	20	640

\* kit fissaggio per sanitari sospesi obbligatorio, non incluso con il sanitario

ACA052	0,3	-	-	25
--------	-----	---	---	----

mandatory fitting system kit for wall-hung sanitaryware, not included with the sanitaryware

\*

Il tappo del troppopieno è coordinato al colore della ceramica, ad eccezione della versione in ceramica bianca lucida, abbinata a tappo cromo.

\*

The overflow cover is matched to the ceramic color, except for the glossy white ceramic version, which is paired with a chrome cover.

# A16 OVERVIEW



THE REEL

THE SANIGLAZE

SCARICO TRASLATO

## A16 | 36 x 52

vaso terra filomuro traslato con nuovo scarico vortice universale, con Saniglaze

back to wall wc with new universal adjustable whirl-flush, with Saniglaze



schede tecniche  
technical drawing

codice	colore	kg	pz. pallet Italia	pz. pallet Export	euro
CLASSIC COLORS					
ASV007	○ 01; 00	28	10	15	470
ASV007	◎ 05; 00	28	10	15	640
ASV007	● 17; 00	28	10	15	640
MATT COLORS					
ASV007	00	28	10	15	640

\* kit fissaggio nascosto per sanitari filomuro obbligatorio, non incluso con il sanitario

ACA039	0,3	-	-	25
--------	-----	---	---	----

mandatory hidden fitting system kit for back to wall sanitaryware, not included with the sanitaryware



THE SANIGLAZE

## A16 | 36 x 52

bidet terra filomuro 1 foro, con Saniglaze

back to wall bidet 1 hole, with Saniglaze



schede tecniche  
technical drawing

codice	colore	kg	pz. pallet Italia	pz. pallet Export	euro
CLASSIC COLORS					
ASB005	○ 01; 00	28	10	15	470
ASB005	◎ 05; 00	28	10	15	640
ASB005	● 17; 00	28	10	15	640
MATT COLORS					
ASB005	00	28	10	15	640

\* kit fissaggio nascosto per sanitari filomuro obbligatorio, non incluso con il sanitario

ACA039	0,3	-	-	25
--------	-----	---	---	----

mandatory hidden fitting system kit for back to wall sanitaryware, not included with the sanitaryware

# A16 OVERVIEW



THE RIMLESS

## A16 MINI | 36 x 45

vaso sospeso Senza Brida

wall-hung Rimless WC



schede tecniche  
technical drawing

codice	colore	kg	pz. pallet Italia	pz. pallet Export	euro
CLASSIC COLORS					
ASV005	○ 01; 00	18	12	20	440
ASV005	◎ 05; 00	18	12	20	610
ASV005	● 17; 00	18	12	20	610

\* kit fissaggio per sanitari sospesi obbligatorio, non incluso con il sanitario

ACA052	0,3	-	-	25
--------	-----	---	---	----

mandatory fitting system kit for wall-hung sanitaryware, not included with the sanitaryware



## A16 MINI | 36 x 45

bidet sospeso 1 foro

wall-hung bidet 1 hole



schede tecniche  
technical drawing

codice	colore	kg	pz. pallet Italia	pz. pallet Export	euro
CLASSIC COLORS					
ASB003	○ 01; 00	18	12	20	440
ASB003	◎ 05; 00	18	12	20	610
ASB003	● 17; 00	18	12	20	610

\* kit fissaggio per sanitari sospesi obbligatorio, non incluso con il sanitario

ACA052	0,3	-	-	25
--------	-----	---	---	----

mandatory fitting system kit for wall-hung sanitaryware, not included with the sanitaryware

# A16 OVERVIEW



## A16

seduta per WC frizionata Slim sgancio rapido

easy take off soft-close  
Slim seat

codice	colore	kg	pz. pallet Italia	pz. pallet Export	euro
CLASSIC COLORS					
ASA001	○ 01; 71	3	-	-	185
ASA001	◎ 05; 71	3	-	-	285
ASA001	● 17; 71	3	-	-	285
MATT COLORS					
ASA001		71	3	-	285



## A16

seduta per WC frizionata a sgancio rapido Magiclight

easy take off soft-close  
Magiclight WC seat

ASA006	○ 01; 20	3,5	-	-	295
--------	----------	-----	---	---	-----



## A16 MINI

seduta per WC frizionata Slim sgancio rapido

easy take off soft-close  
Slim seat

codice	colore	kg	pz. pallet Italia	pz. pallet Export	euro
CLASSIC COLORS					
ASA002	○ 01; 71	3	-	-	185
ASA002	◎ 05; 71	3	-	-	285
ASA002	● 17; 71	3	-	-	285





## A16 MINI

seduta per WC frizionata a sgancio rapido Magiclight

easy take off soft-close  
Magiclight WC seat

ASA002	○ 01; 20	3,5	-	-	295
--------	----------	-----	---	---	-----

# A16 ACCESSORIES

	codice	colore	kg	pz. pallet Italia	pz. pallet Export	euro
piletta universale up & down cromo <i>chrome up &amp; down drain</i>	<b>ACA032</b>		0,3	-	-	<b>75</b>
<div style="display: flex; align-items: center;"> <div style="border: 1px solid blue; border-radius: 50%; padding: 5px; margin-right: 10px; text-align: center;"> <p style="color: blue; font-weight: bold; margin: 0;">THE. SANIGLAZE</p> </div> <div> <p>piletta universale up &amp; down con tappo in ceramica, con Saniglaze</p> <p><i>up &amp; down universal drain with ceramic cover for washbasins, with Saniglaze</i></p> </div> <div style="margin-left: 20px;"> <p>CLASSIC COLORS</p> <p><b>ACA036</b>  <b>01; 34</b> 0,3 - - <b>80</b></p> <p><b>ACA038</b>  <b>05; 34</b> 0,3 - - <b>90</b></p> <p><b>ACA038</b>  <b>17; 34</b> 0,3 - - <b>90</b></p> </div> </div>						
sifone ridotto - <i>reduced siphon</i>	<b>ACA021</b>		1	-	-	<b>100</b>
staffe di fissaggio per sospesi <i>fitting system kit for wall-hung</i>	<b>ACA016</b>		4	-	-	<b>70</b>
riduttore di flusso di scarico per WC <i>plug for reducing water flow</i>	<b>ACA064</b>		4	-	-	<b>15</b>
curva tecnica traslata <i>adjustable pipe</i>	<b>ACA074</b>		0,3	-	-	<b>40</b>
curva tecnica S <i>elbow at floor S</i>	<b>ACA005</b>		0,3	-	-	<b>25</b>
manicotto concentrico <i>concentric pipe</i>	<b>ACA076</b>		0,3	-	-	<b>20</b>

# A16 ACCESSORIES

	codice	colore	kg	pz. pallet Italia	pz. pallet Export	euro
manicotto eccentrico 2 cm <i>eccentric pipe 2 cm</i>	<b>ACA077</b>		0,3	-	-	<b>20</b>
manicotto eccentrico 4 cm <i>eccentric pipe 4 cm</i>	<b>ACA078</b>		0,3	-	-	<b>25</b>
raccordo scarico parete "P" traslato <i>"P" trap adjustable pipe</i>	<b>ACA075</b>		0,3	-	-	<b>25</b>
protezione adesiva antirumore zig/zag <i>soundproof zig/zag</i>	<b>ACA104</b>		0,3	-	-	<b>15</b>

# VITA



Scopri online  
Discover it online

Collezione di sanitari a terra  
filomuro e sospesi scarico  
The.Reel

Wall-hung and back to wall  
The.Reel sanitaryware collection



# SANITARYWARE COLLECTION

The natural shape of living.  
Vita was created with the idea of transforming everyday life into a gesture that is simple, natural, and harmonious. Soft, welcoming, and perfectly balanced lines define a collection with a fluid, contemporary language designed to blend effortlessly into any interior style. Available in both wall-hung and floor-standing close-coupled versions, Vita adapts seamlessly to modern living spaces and rhythms.

# La forma naturale del vivere.

Vita nasce dall'idea di trasformare la quotidianità in un gesto semplice, naturale e armonioso. Linee morbide, accoglienti e perfettamente bilanciate definiscono una collezione dal linguaggio fluido e contemporaneo, pensata per inserirsi con spontaneità in ogni stile abitativo. Disponibile in versione sospesa o a terra filomuro, Vita si adatta con facilità agli spazi e ai ritmi dell'abitare moderno.

**VIV001 + FLA016 | 37 x 53**

Vaso sospeso con nuovo scarico universale a vortice  
Wall-hung wc with new universal whirl-flush

**VIB001 | 37 x 53**

Bidet sospeso  
Wall-hung bidet



**VIV001 + FLA016 | 37 x 53**

Vaso sospeso con nuovo  
scarico universale a vortice  
*Wall-hung wc with new  
universal whirl-flush*

**VIB001 | 37 x 53**

Bidet sospeso  
*Wall-hung bidet*



Vita does not aim to impress through excess, but through simplicity. Each element is designed to appear visually light, achieving a natural balance between form and technology that makes the space more essential, fluid, and "alive". The collection gently supports everyday life, restoring the bathroom to its most authentic and human dimension, where functionality and beauty coexist in a harmonious and intuitive way.

Vita non vuole sorprendere con eccessi, ma con la sua semplicità. Ogni elemento è progettato per essere visivamente leggero, raggiungendo un equilibrio naturale tra forma e tecnologia che rende lo spazio più essenziale, fluido e "vivo". La collezione accompagna il quotidiano con delicatezza, restituendo all'ambiente bagno la sua dimensione più autentica e umana, dove funzionalità e bellezza convivono in modo armonioso e intuitivo.

A destra / On the right:

**VIV001 + FLA016 | 37 x 53**

Vaso sospeso con nuovo  
scarico universale a vortice  
*Wall-hung wc with new  
universal whirl-flush*

**VIB001 | 37 x 53**

Bidet sospeso  
*Wall-hung bidet*





**VIV002 + FLA018 | 36 x 52**

Vaso terra filomuro traslato  
con nuovo scarico vortice universale  
*Back to wall wc with new universal  
adjustable whirl-flush*

**VIB002 | 36 x 52**

Bidet terra filomuro  
*Back to wall bidet*





A destra / On the right:

**VIV002 + FLA018 | 36 x 52**

Vaso terra filomuro traslato  
con nuovo scarico vortice  
universale

*Back to wall wc with new  
universal adjustable whirl-flush*

**VIB002 | 36 x 52**

Bidet terra filomuro  
*Back to wall bidet*



# VITA COLLECTION DNA

Scopri le caratteristiche tecniche principali della collezione Vita  
Discover the main technical features of the Vita collection

## THE REEL

Sistema di scarico a vortice universale: può essere installato sia su cassette standard 6/3 L, sia su cassette a risparmio idrico 4/2 L, garantendo sempre un risciacquo potente, uniforme e silenzioso.

*Universal vortex flush system: can be installed on both standard 6/3 L cisterns and water-saving 4/2 L models, while always ensuring a powerful, even and quiet flush.*



## THE SANIGLAZE

Trattamento antibatterico ed easy-to-clean integrato nella ceramica: gli ioni attivi rendono la superficie più liscia, idrofila, brillante e resistente, con protezione certificata.

*Antibacterial, easy-to-clean treatment built into the ceramic: active ions make the surface smoother, hydrophilic, shinier, and more durable, with certified protection.*



**-99,98%  
BACTERIA**



## SCARICO TRASLATO

Il vaso filomuro dispone di scarico traslato. Le connessioni di scarico sono regolabili grazie agli abbinamenti delle curve con i manicotti (concentrico od eccentrici) - da acquistare separatamente.

*The back to wall WC has an adjustable flush. Drainage connections can be adjust thanks to the combinations of the curves with the pipes (concentric or eccentric) - to be purchased separately.*

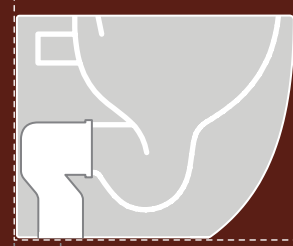

**ACA005 + ACA076 > 10 CM**  
**ACA005 + ACA077 > 8/10 CM**  
**ACA005 + ACA078 > 14 CM**  
CURVA TECNICA S + MANICOTTO DI SCARICO A PAVIMENTO ELBOW AT FLOOR S + ARRANGEMENT DISCHARGE TO FLOOR

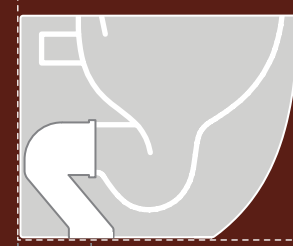

**ACA074 + ACA076 > 15 CM**  
**ACA074 + ACA077 > 13/17 CM**  
CURVA TECNICA TRASLATA + MANICOTTO DI SCARICO A PAVIMENTO ADJUSTABLE PIPE + ARRANGEMENT DISCHARGE TO FLOOR

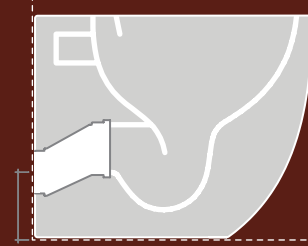

**ACA075**  
RACCORDO DI SCARICO A PARETE TRASLATO H 18 CM WALL TRAP ADJUSTABLE PIPE H 18 CM

## HIDDEN FIXING SYSTEM

Sistema di fissaggio nascosto: installazione pulita ed essenziale, senza elementi visibili. Garantisce montaggio semplice, stabile e preciso, con estetica impeccabile.

*Hidden fixing system: clean, minimal installation with no visible elements. Ensures easy, stable and precise mounting while preserving flawless design.*

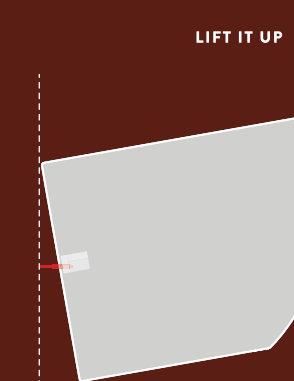
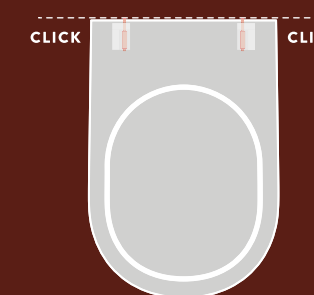
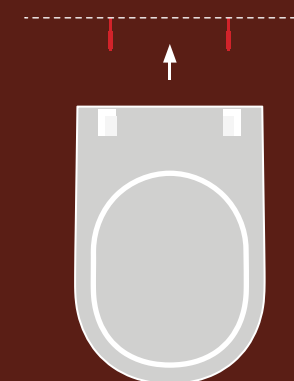

# VITA STYLES

## CLASSIC COLORS



cod. 01  
bianco lucido / glossy white



cod. 05  
bianco matt / matt white



cod. 17  
nero matt / matt black

## MATT COLORS



cod. 41  
marrone matra / brown matra



cod. 59  
sabbia / sand



cod. 60  
ghiaia / gravel

# VITA OVERVIEW



THE REEL

## VITA | 37 x 53

vaso sospeso con nuovo scarico universale a vortice, con Saniglaze

THE SANIGLAZE

wall-hung wc with new universal whirl-flush, with Saniglaze



schede tecniche  
technical drawing

codice	colore	kg	pz. pallet Italia	pz. pallet Export	euro
--------	--------	----	-------------------	-------------------	------

### CLASSIC COLORS

VIV001	○ 01; 00	24,5	12	20	380
VIV001	◎ 05; 00	24,5	12	20	530
VIV001	● 17; 00	24,5	12	20	530

### MATT COLORS

VIV001	00	24,5	12	20	530
--------	----	------	----	----	-----

\* kit fissaggio per sanitari sospesi obbligatorio, non incluso con il sanitario

ACA052	0,3	-	-	25
--------	-----	---	---	----

mandatory fitting system kit for wall-hung sanitaryware, not included with the sanitaryware



THE SANIGLAZE

## VITA | 37 x 53

bidet sospeso 1 foro, con Saniglaze

wall-hung bidet 1 hole, with Saniglaze



schede tecniche  
technical drawing

### CLASSIC COLORS

VIB001	○ 01; 00	21	12	20	380
VIB001	◎ 05; 00	21	12	20	530
VIB001	● 17; 00	21	12	20	530

### MATT COLORS

VIB001	00	21	12	20	530
--------	----	----	----	----	-----

\* kit fissaggio per sanitari sospesi obbligatorio, non incluso con il sanitario

ACA052	0,3	-	-	25
--------	-----	---	---	----

mandatory fitting system kit for wall-hung sanitaryware, not included with the sanitaryware

\*

Il tappo del troppopieno è coordinato al colore della ceramica, ad eccezione della versione in ceramica bianca lucida, abbinata a tappo cromo.

\*

The overflow cover is matched to the ceramic color, except for the glossy white ceramic version, which is paired with a chrome cover.

# VITA OVERVIEW



THE REEL

THE SANIGLAZE

SCARICO TRASLATO

## VITA | 36 x 52

vaso terra filomuro traslato con nuovo scarico vortice universale, con Saniglaze

back to wall wc with new universal adjustable whirl-flush, with Saniglaze



schede tecniche  
technical drawing

codice	colore	kg	pz. pallet Italia	pz. pallet Export	euro
CLASSIC COLORS					
VIV002	01	27,5	10	20	380
VIV002	05	27,5	10	20	530
VIV002	17	27,5	10	20	530
MATT COLORS					
VIV002	00	27,5	10	20	530

\* kit fissaggio nascosto per sanitari filomuro obbligatorio, non incluso con il sanitario

mandatory hidden fitting system kit for back to wall sanitaryware, not included with the sanitaryware

ACA039	0,3	-	-	-	25
--------	-----	---	---	---	----



THE SANIGLAZE

## VITA | 36 x 52

bidet terra filomuro 1 foro, con Saniglaze

back to wall bidet 1 hole, with Saniglaze



schede tecniche  
technical drawing

codice	colore	kg	pz. pallet Italia	pz. pallet Export	euro
CLASSIC COLORS					
VIB002	01	24	10	20	380
VIB002	05	24	10	20	530
VIB002	17	24	10	20	530
MATT COLORS					
VIB002	00	24	10	20	530

\* kit fissaggio nascosto per sanitari filomuro obbligatorio, non incluso con il sanitario

mandatory hidden fitting system kit for back to wall sanitaryware, not included with the sanitaryware

ACA039	0,3	-	-	-	25
--------	-----	---	---	---	----

# VITA OVERVIEW



## VITA/SOLIDA

seduta Flat avvolgente per WC frizionata a sgancio rapido

easy take off soft-close enveloping Flat WC seat

codice	colore	kg	pz. pallet Italia	pz. pallet Export	euro
CLASSIC COLORS					
FLA018	01	3	-	-	185
FLA018	05	3	-	-	280
FLA018	17	3	-	-	280
MATT COLORS					
FLA018		3	-	-	280



## VITA/SOLIDA

seduta Flat per WC frizionata a sgancio rapido

easy take off soft-close Flat WC seat

codice	colore	kg	pz. pallet Italia	pz. pallet Export	euro
CLASSIC COLORS					
FLA016	01	71	3	-	185
FLA016	05	71	3	-	280
FLA016	17	71	3	-	280
MATT COLORS					
FLA016		3	-	-	280



## VITA/SOLIDA

seduta Flat per WC frizionata a sgancio rapido Magiclight

easy take off soft-close Magiclight Flat WC seat

FLA016	01	20	3,5	-	295
--------	----	----	-----	---	-----



## VITA

seduta contract Flat per WC frizionata a sgancio rapido

easy take off soft-close contract Flat WC seat

FLA019	01	3,5	-	-	95
--------	----	-----	---	---	----

# VITA ACCESSORIES

	codice	colore	kg	pz. pallet Italia	pz. pallet Export	euro
piletta universale up & down cromo  <i>chrome up &amp; down drain</i>	<b>ACA032</b>		0,3	-	-	<b>75</b>
 <p>piletta universale up &amp; down con tappo in ceramica, con Saniglaze</p> <p><i>up &amp; down universal drain with ceramic cover for washbasins, with Saniglaze</i></p>	CLASSIC COLORS					
	<b>ACA036</b>	○ 01; 34	0,3	-	-	<b>80</b>
	<b>ACA038</b>	◎ 05; 34	0,3	-	-	<b>90</b>
	<b>ACA038</b>	● 17; 34	0,3	-	-	<b>90</b>
	MATT COLORS					
<b>ACA038</b>		34	0,3	-	-	<b>90</b>
sifone ridotto - <i>reduced siphon</i>	<b>ACA021</b>		1	-	-	<b>100</b>
staffe di fissaggio per sospesi <i>fitting system kit for wall-hung</i>	<b>ACA016</b>		4	-	-	<b>70</b>
riduttore di flusso di scarico per WC <i>plug for reducing water flow</i>	<b>ACA064</b>		4	-	-	<b>15</b>
curva tecnica traslata <i>adjustable pipe</i>	<b>ACA074</b>		0,3	-	-	<b>40</b>
curva tecnica S <i>elbow at floor S</i>	<b>ACA005</b>		0,3	-	-	<b>25</b>

# VITA ACCESSORIES

	codice	colore	kg	pz. pallet Italia	pz. pallet Export	euro
manicotto concentrico <i>concentric pipe</i>	<b>ACA076</b>		0,3	-	-	<b>20</b>
manicotto eccentrico 2 cm <i>eccentric pipe 2 cm</i>	<b>ACA077</b>		0,3	-	-	<b>20</b>
manicotto eccentrico 4 cm <i>eccentric pipe 4 cm</i>	<b>ACA078</b>		0,3	-	-	<b>25</b>
raccordo scarico parete "P" traslato <i>"P" trap adjustable pipe</i>	<b>ACA075</b>		0,3	-	-	<b>25</b>
protezione adesiva antirumore zig/zag <i>soundproof zig/zag</i>	<b>ACA104</b>		0,3	-	-	<b>15</b>

# ATE LIER



Scopri online  
Discover it online

Collezione di sanitari a terra  
filomuro e sospesi scarico  
The.Rimless; con lavabi  
coordinati

Wall-hung and back to  
wall The.Rimless sanitaryware  
collection; with coordinated  
washbasins



**SANITARYWARE  
& WASHBASINS  
COLLECTION**

Minimal-Retró: where eras meet.  
We live in a fascinating and complex world, full of contrasts and contradictions. We look ahead, yet remain deeply connected to our past; we embrace technology while treasuring the scents and flavors of memory. "Melting pot" and "vintage" perfectly describe the spirit of the Atelier collection.

# Minimal-Retró: l'incontro tra epoche.

Viviamo in un mondo straordinario, complesso, fatto di contrasti e contraddizioni. Guardiamo avanti ma restiamo legati al passato; abbracciamo l'innovazione tecnologica ma custodiamo gli odori e i sapori della memoria. "Melting pot" e "vintage" sono le parole chiave che meglio descrivono la collezione Atelier.



**ATV001 + AZA001 | 37 x 52**  
Vaso sospeso Senza Breda  
Wall-hung Rimless WC

**ATB001 | 37 x 52**  
Bidet sospeso  
Wall-hung bidet

ATV001 + AZA001 | 37 x 52  
Vaso sospeso Senza Brida  
Wall-hung Rimless WC

ATB001 | 37 x 52  
Bidet sospeso  
Wall-hung bidet



A true creative atelier where past and present meet, giving life to a minimal-retró collection: clean, linear shapes enhanced by a fine rim that contrasts and harmonizes with the rounded, iconic profile – a perfect balance between essential design and timeless memory.

Un vero e proprio laboratorio creativo dove presente e passato si incontrano per dare vita a una collezione minimal-retró: lineare nelle forme, impreziosita da un bordo sottile che dialoga con la rotondità e l'iconicità del suo profilo, in un perfetto equilibrio tra essenzialità e memoria.

**ATV001 + AZA001 | 37 x 52**  
Vaso sospeso Senza Brida  
Wall-hung Rimless WC

**ATB001 | 37 x 52**  
Bidet sospeso  
Wall-hung bidet

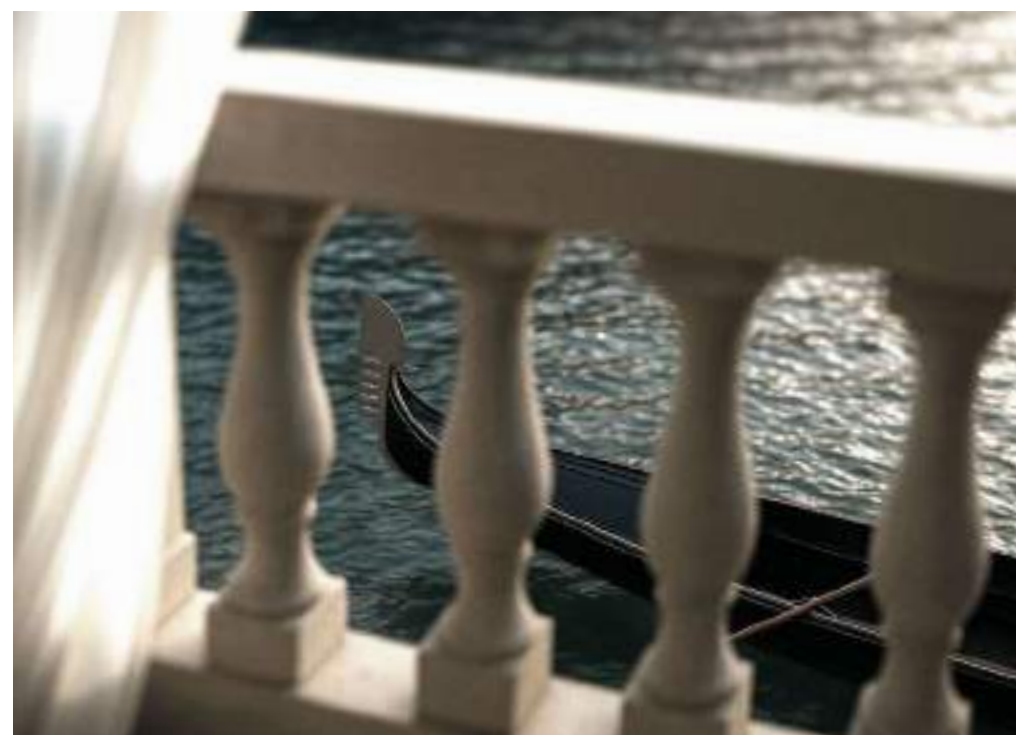



A sinistra / On the left:

**ATV002 + AZA001 | 37 x 52**  
Vaso terra filomuro Senza Brida  
*Back to wall Rimless WC*

**ATB002 | 37 x 52**  
Bidet terra filomuro  
*Back to wall bidet*



**ATV002 + AZA001 | 37 x 52**

Vaso terra filomuro Senza Brida  
Back to wall Rimless WC

**ATB002 | 37 x 52**

Bidet terra filomuro  
Back to wall bidet





**ATL002 | 60 x 40**  
Lavabo appoggio  
*Countertop washbasin*





**ATL001 | Ø 44**  
Lavabo appoggio  
*Countertop washbasin*



# ATELIER COLLECTION DNA

Scopri le caratteristiche tecniche principali della collezione Atelier  
*Discover the main technical features of the Atelier collection*

## THE RIMLESS

Sistema di scarico senza brida: niente zone nascoste, pulizia più facile e getto uniforme per migliore igiene ed efficienza.

*Rimless flush system: no hidden areas, easier cleaning, and an even water flow for better hygiene and efficiency.*



## HIDDEN FIXING SYSTEM

Sistema di fissaggio nascosto: installazione pulita ed essenziale, senza elementi visibili. Garantisce montaggio semplice, stabile e preciso, con estetica impeccabile.

*Hidden fixing system: clean, minimal installation with no visible elements. Ensures easy, stable and precise mounting while preserving flawless design.*



## THE SANIGLAZE

Trattamento antibatterico ed easy-to-clean integrato nella ceramica: gli ioni attivi rendono la superficie più liscia, idrofila, brillante e resistente, con protezione certificata.

*Antibacterial, easy-to-clean treatment built into the ceramic: active ions make the surface smoother, hydrophilic, shinier, and more durable, with certified protection.*



# ATELIER STYLES

## CLASSIC COLORS



cod. 01

bianco lucido / glossy white



cod. 05

bianco matt / matt white



cod. 17

nero matt / matt black

# ATELIER OVERVIEW



THE RIMLESS

THE SANIGLAZE

## ATELIER | 37 x 52

vaso sospeso Senza Brida, con Saniglaze

wall-hung Rimless WC, with Saniglaze



schede tecniche  
technical drawing

codice	colore	kg	pz. pallet Italia	pz. pallet Export	euro
--------	--------	----	-------------------	-------------------	------

### CLASSIC COLORS

ATV001	○ 01; 00	21	12	20	460
ATV001	◎ 05; 00	21	12	20	640
ATV001	● 17; 00	21	12	20	640

\* kit fissaggio per sanitari sospesi obbligatorio, non incluso con il sanitario

ACA052

0,3 - - 25

mandatory fitting system kit for wall-hung sanitaryware, not included with the sanitaryware



THE SANIGLAZE

## ATELIER | 37 x 52

bidet sospeso 1 foro, con Saniglaze

wall-hung bidet 1 hole, with Saniglaze



schede tecniche  
technical drawing

### CLASSIC COLORS

ATB001	○ 01; 00	20	12	20	460
ATB001	◎ 05; 00	20	12	20	640
ATB001	● 17; 00	20	12	20	640

\* kit fissaggio per sanitari sospesi obbligatorio, non incluso con il sanitario

ACA052

0,3 - - 25

mandatory fitting system kit for wall-hung sanitaryware, not included with the sanitaryware

\*

Il tappo del troppopieno è coordinato al colore della ceramica, ad eccezione della versione in ceramica bianca lucida, abbinata a tappo cromo.

\*

The overflow cover is matched to the ceramic color, except for the glossy white ceramic version, which is paired with a chrome cover.

# ATELIER OVERVIEW



THE RIMLESS

THE SANIGLAZE

## ATELIER | 37 x 52

vaso terra filomuro Senza Brida, con Saniglaze

back to wall Rimless WC, with Saniglaze



schede tecniche  
technical drawing

codice	colore	kg	pz. pallet Italia	pz. pallet Export	euro
CLASSIC COLORS					
ATV002	○ 01; 00	29	10	20	460
ATV002	◎ 05; 00	29	10	20	640
ATV002	● 17; 00	29	10	20	640

\* kit fissaggio nascosto per sanitari filomuro obbligatorio, non incluso con il sanitario

ACA039 0,3 - - 25

mandatory hidden fitting system kit for back to wall sanitaryware, not included with the sanitaryware



THE SANIGLAZE

## ATELIER | 37 x 52

bidet terra filomuro 1 foro, con Saniglaze

back to wall bidet 1 hole, with Saniglaze



schede tecniche  
technical drawing

codice	colore	kg	pz. pallet Italia	pz. pallet Export	euro
CLASSIC COLORS					
ATB002	○ 01; 00	28	10	20	460
ATB002	◎ 05; 00	28	10	20	640
ATB002	● 17; 00	28	10	20	640

\* kit fissaggio nascosto per sanitari filomuro obbligatorio, non incluso con il sanitario

ACA039 0,3 - - 25

mandatory hidden fitting system kit for back to wall sanitaryware, not included with the sanitaryware

# ATELIER OVERVIEW



## ATELIER/AZULEY

seduta per WC frizionata, cerniera cromo

soft-close WC seat, chrome hinge

codice	colore	kg	pz. pallet Italia	pz. pallet Export	euro
CLASSIC COLORS					
AZA001	○ 01; 71	3,7	-	-	185
AZA001	◎ 05; 71	3,7	-	-	280
AZA001	● 17; 71	3,7	-	-	280

## ATELIER/AZULEY

seduta per WC frizionata a sgancio rapido Magiclight

easy take off soft-close Magiclight WC seat

codice	colore	kg	pz. pallet Italia	pz. pallet Export	euro
AZA001	○ 01; 20	3,5	-	-	295

# ATELIER OVERVIEW



THE.  
SANIGLAZE

## ATELIER | Ø44

lavabo appoggio, con Saniglaze

countertop washbasin,  
with Saniglaze



schede tecniche  
technical drawing

codice	colore	kg	pz. pallet Italia	pz. pallet Export	euro
CLASSIC COLORS					
ATL001	○ 01; 00	10	24	48	320
ATL001	◎ 05; 00	10	24	48	480
ATL001	● 17; 00	10	24	48	480



THE.  
SANIGLAZE

## ATELIER | 60 x 40

lavabo appoggio, con Saniglaze

countertop washbasin,  
with Saniglaze



schede tecniche  
technical drawing

codice	colore	kg	pz. pallet Italia	pz. pallet Export	euro
CLASSIC COLORS					
ATL002	○ 01; 00	12	20	40	345
ATL002	◎ 05; 00	12	20	40	520
ATL002	● 17; 00	12	20	40	520

# ATELIER ACCESSORIES

piletta universale  
up & down cromo

ACA032 0,3 - - 75

chrome up & down drain

THE.  
SANIGLAZE

piletta universale up & down  
con tappo in ceramica,  
con Saniglaze

codice	colore	kg	pz. pallet Italia	pz. pallet Export	euro
CLASSIC COLORS					
ACA036	○ 01; 34	0,3	-	-	80
ACA038	◎ 05; 34	0,3	-	-	90
ACA038	● 17; 34	0,3	-	-	90

up & down universal drain with  
ceramic cover for washbasins,  
with Saniglaze

piletta cromo con troppo pieno  
integrato

ACA096 0,3 - - 85

chrome drain with integral  
overflow

THE.  
SANIGLAZE

piletta con tappo in ceramica  
e troppo pieno integrato,  
con Saniglaze

codice	colore	kg	pz. pallet Italia	pz. pallet Export	euro
CLASSIC COLORS					
ACA097	○ 01; 34	0,3	-	-	90
ACA097	◎ 05; 34	0,3	-	-	90
ACA097	● 17; 34	0,3	-	-	90

drain with ceramic cover  
and integral overflow,  
with Saniglaze

sifone ridotto - reduced siphon

ACA021 1 - - 100

staffe di fissaggio per sospesi  
fitting system kit for wall-hung

ACA016 4 - - 70

riduttore di flusso di scarico per WC  
plug for reducing water flow

ACA064 4 - - 15

protezione adesiva antirumore  
zig/zag  
soundproof zig/zag

ACA104 0,3 - - 15

# FILE 2.0



Scopri la online  
Discover it online

Collezione di sanitari a terra  
filomuro e sospesi scarico  
The.Rimless

Wall-hung and back to wall  
The.Rimless sanitaryware  
collection



# SANITARYWARE COLLECTION

Evolution of a timeless icon.  
Soft lines and harmonious proportions define File 2.0, a sanitaryware collection designed to adapt naturally to a wide range of settings. It combines formal simplicity with functionality, establishing itself as one of Artceram's most recognizable and appreciated collections. Small refinements introduced over time have made File 2.0 an even more balanced and functional proposal, confirming its role as a best-seller and a reliable choice for those seeking timeless, dependable design.

# Evoluzione di un'icona senza tempo.

Linee morbide e proporzioni armoniose definiscono File 2.0, una collezione di sanitari capace di adattarsi con naturalezza a contesti diversi. Unisce semplicità formale e funzionalità, affermandosi come una delle collezioni più riconoscibili e apprezzate di Artceram. Piccoli affinamenti introdotti nel tempo hanno reso File 2.0 una proposta ancora più equilibrata e funzionale, confermandone il ruolo di best-seller e di scelta sicura per chi cerca un design senza tempo e affidabile.

**FLV004 + FLA014 | 37 x 52**  
Vaso sospeso Senza Brida  
Wall-hung Rimless WC

**FLB001 | 37 x 52**  
Bidet sospeso  
Wall-hung bidet



FLV004 + FLA014 | 37 x 52

Vaso sospeso Senza Brida  
Wall-hung Rimless WC

FLB001 | 37 x 52

Bidet sospeso  
Wall-hung bidet



The rounded, clean design is paired with the Rimless flushing system, which ensures maximum hygiene and ease of cleaning by eliminating the internal rim. A technical solution that enhances ceramic continuity and improves everyday user experience. Versatile and contemporary, File 2.0 can adapt effortlessly to both residential and contract environments.

Il design arrotondato e pulito dialoga con il sistema di scarico Rimless, che garantisce massima igiene e facilità di pulizia grazie all'eliminazione del bordo interno. Una soluzione tecnica che valorizza la continuità della ceramica e migliora l'esperienza d'uso quotidiana. Versatile e contemporanea, File 2.0 si adatta con disinvoltura sia ad ambienti residenziali sia contract.

**FLV004 + FLA014 | 37 x 52**  
Vaso sospeso Senza Brida  
*Wall-hung Rimless WC*

**FLB001 | 37 x 52**  
Bidet sospeso  
*Wall-hung bidet*



**FLV005 + FLA014 | 37 x 52**  
Vaso terra filomuro Senza Brida traslato  
*Back to wall Rimless WC*

**FLB002 | 37 x 52**  
Bidet terra filomuro  
*Back to wall bidet*





**FLV005 + FLA014 | 37 x 52**  
Vaso terra filomuro Senza Brida traslato  
*Back to wall Rimless WC*

**FLB002 | 37 x 52**  
Bidet terra filomuro  
*Back to wall bidet*



# FILE 2.0 COLLECTION DNA

Scopri le caratteristiche tecniche principali della collezione File 2.0  
*Discover the main technical features of the File 2.0 collection*

## THE RIMLESS

Sistema di scarico senza brida: niente zone nascoste, pulizia più facile e getto uniforme per migliore igiene ed efficienza.

*Rimless flush system: no hidden areas, easier cleaning, and an even water flow for better hygiene and efficiency.*



## SCARICO TRASLATO

Il vaso filomuro dispone di scarico traslato. Le connessioni di scarico sono regolabili grazie agli abbinamenti delle curve con i manicotti (concentrico od eccentrici) – da acquistare separatamente.

*The back to wall WC has an adjustable flush. Drainage connections can be adjust thanks to the combinations of the curves with the pipes (concentric or eccentric) – to be purchased separately.*

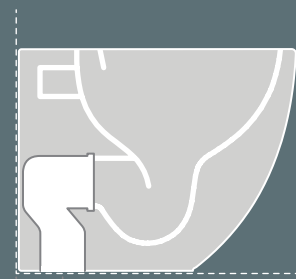

**ACA005**  
CURVA TECNICA S  
SCARICO FISSO 15 CM  
ELBOW AT FLOOR S  
FIXED DRAIN 15 CM

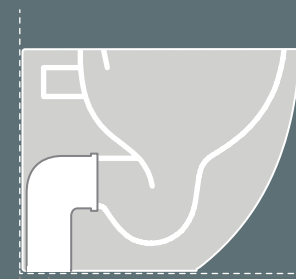

**ACA033**  
CURVA TECNICA A 90°  
REGOLABILE DA 7 A 14 CM  
ADJUSTABLE 90° ELBOW  
FROM 7 TO 14 CM

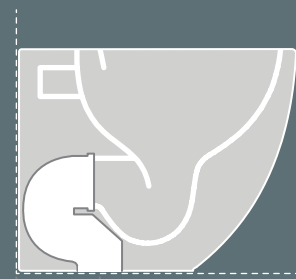

# FILE 2.0 STYLES

## CLASSIC COLORS



cod. 01  
bianco lucido / glossy white



cod. 05  
bianco matt / matt white

# FILE 2.0 OVERVIEW



THE RIMLESS

## FILE 2.0 | 37 x 52

vaso sospeso Senza Brida + kit di fissaggio

wall-hung Rimless WC + fitting system kit



schede tecniche  
technical drawing

codice	colore	kg	pz. pallet Italia	pz. pallet Export	euro
CLASSIC COLORS					
FLV004	○ 01; 30	22	12	20	349
FLV004	◎ 05; 30	22	12	20	449

\* kit fissaggio per sanitari sospesi obbligatorio, non incluso con il sanitario

ACA052 0,3 - - 25

mandatory fitting system kit for wall-hung sanitaryware, not included with the sanitaryware



## FILE 2.0 | 37 x 52

bidet sospeso 1 foro

wall-hung bidet 1 hole



schede tecniche  
technical drawing

codice	colore	kg	pz. pallet Italia	pz. pallet Export	euro
CLASSIC COLORS					
FLB001	○ 01; 30	19	12	20	349
FLB001	◎ 05; 30	19	12	20	449

\* kit fissaggio per sanitari sospesi obbligatorio, non incluso con il sanitario

ACA052 0,3 - - 25

mandatory fitting system kit for wall-hung sanitaryware, not included with the sanitaryware

\*

Il tappo del troppopieno è coordinato al colore della ceramica, ad eccezione della versione in ceramica bianca lucida, abbinata a tappo cromo.

\*

The overflow cover is matched to the ceramic color, except for the glossy white ceramic version, which is paired with a chrome cover.

# FILE 2.0 OVERVIEW



THE RIMLESS

SCARICO TRASLATO

## FILE 2.0 | 37 x 52

vaso terra filomuro Senza Brida traslato

back to wall Rimless Wc adjustable flush



schede tecniche  
technical drawing

codice	colore	kg	pz. pallet Italia	pz. pallet Export	euro
CLASSIC COLORS					
FLV005	○ 01; 30	27	12	20	349
FLV005	◎ 05; 30	27	12	20	449

\* kit fissaggio laterale per sanitari obbligatorio, non incluso con il sanitario

ACA020 0,3 - - 15

mandatory fitting system kit for sanitaryware, not included with the sanitaryware



## FILE 2.0 | 37 x 52

bidet terra filomuro 1 foro

back to wall bidet 1 hole



schede tecniche  
technical drawing

codice	colore	kg	pz. pallet Italia	pz. pallet Export	euro
CLASSIC COLORS					
FLB002	○ 01; 30	23	12	20	349
FLB002	◎ 05; 30	23	12	20	449

\* kit fissaggio laterale per sanitari obbligatorio, non incluso con il sanitario

ACA020 0,3 - - 15

mandatory fitting system kit for sanitaryware, not included with the sanitaryware

# FILE 2.0 OVERVIEW



## FILE 2.0 | 37 x 67

vaso monoblocco

close-coupled Wc



schede tecniche  
technical drawing

\* kit fissaggio laterale per sanitari obbligatorio, non incluso con il sanitario

mandatory fitting system kit for sanitaryware, not included with the sanitaryware



## FILE 2.0 | 32 x 50

cassetta monoblocco

ceramic cistern

meccanismo di scarico doppio flusso per FLC001

waste system double flow for FLC001

codice	colore	kg	pz. pallet Italia	pz. pallet Export	euro
FLV003	○ 01; ○ 00	34	6	9	490

ACA020		0,3	-	-	15
--------	--	-----	---	---	----

FLC001	○ 01; ○ 00	12	-	-	170
--------	------------	----	---	---	-----

FLA001		5	-	-	105
--------	--	---	---	---	-----

# FILE 2.0 OVERVIEW



## FILE 2.0

seduta Slim per WC frizionata a sgancio rapido

easy take off soft-close  
Slim WC seat



## FILE 2.0

seduta Slim per WC frizionata a sgancio rapido Magiclight

easy take off soft-close  
Magiclight Slim WC seat



## FILE 2.0

seduta contract Flat avvolgente per WC frizionata a sgancio rapido

easy take off soft-close  
enveloping Flat WC seat

codice	colore	kg	pz. pallet Italia	pz. pallet Export	euro
CLASSIC COLORS					
FLA014	○ 01	3	-	-	185
FLA014	⊙ 05	3	-	-	280

FLA014	○	20	3,5	-	-	295
--------	---	----	-----	---	---	-----

FLA017	○ 01	3,5	-	-	95
--------	------	-----	---	---	----

## FILE 2.0 ACCESSORIES



	codice	colore	kg	pz. pallet Italia	pz. pallet Export	euro
piletta universale up & down cromo <i>chrome up &amp; down drain</i>	<b>ACA032</b>		0,3	-	-	<b>75</b>
piletta universale up & down con tappo in ceramica, con Saniglaze	<b>ACA036</b>	○ 01; 34	0,3	-	-	<b>80</b>
	<b>ACA038</b>	◎ 05; 34	0,3	-	-	<b>90</b>
<i>up &amp; down universal drain with ceramic cover for washbasins, with Saniglaze</i>						
sifone ridotto - <i>reduced siphon</i>	<b>ACA021</b>		1	-	-	<b>100</b>
staffe di fissaggio per sospesi <i>fitting system kit for wall-hung</i>	<b>ACA016</b>		4	-	-	<b>70</b>
riduttore di flusso di scarico per WC <i>plug for reducing water flow</i>	<b>ACA064</b>		4	-	-	<b>15</b>
curva tecnica S <i>elbow at floor S</i>	<b>ACA005</b>		0,3	-	-	<b>25</b>
raccordo a parete P <i>pipe at wall P</i>	<b>ACA004</b>		0,3	-	-	<b>29</b>
cannotto traslato per modifica ingresso acqua +/- 2 cm  <i>adjustable pipe for water inlet change +/- 2 cm</i>	<b>ACA035</b>		0,2	-	-	<b>29</b>

## FILE 2.0 ACCESSORIES

	codice	colore	kg	pz. pallet Italia	pz. pallet Export	euro
curva tecnica 90° regolabile <i>adjustable 90° elbow</i>	<b>ACA033</b>		1	-	-	<b>35</b>
curva tecnica traslata regolabile <i>adjustable pipe</i>	<b>ACA034</b>		1	-	-	<b>35</b>
protezione adesiva antirumore zig/zag <i>soundproof zig/zag</i>	<b>ACA104</b>		0,3	-	-	<b>15</b>

# MO NET



Scopri online  
Discover it online

Collezione di sanitari a terra  
filomuro e sospesi scarico  
The.Rimless; con variante PLUS  
a dimensioni maggiorate

Wall-hung and back to  
wall The.Rimless sanitaryware  
collection; with the PLUS  
version, featuring increased  
dimensions



# SANITARYWARE COLLECTION

Welcoming Balance.

Monet is a collection of floor-standing and wall-hung rimless sanitaryware with adjustable flush, designed to anticipate and fulfill the desires of its users. Classic lines are reinterpreted in a contemporary key through generous shapes, essential profiles, and clean geometries. It's a formal aesthetic synthesis between straight and curved lines, between stillness and movement - crafted to soothe the senses and convey a deep sense of well-being.

# Equilibrio che accoglie.

Monet è una collezione di sanitari a terra e sospesi, rimless e con scarico traslato, pensata per intuire e soddisfare i desideri del pubblico. Le linee classiche vengono reinterpretate in chiave contemporanea attraverso forme generose, profili essenziali e geometrie pulite. Un equilibrio tra curve e linee rette, tra staticità e movimento, per un'estetica che parla ai sensi e trasmette una sensazione di armonia e benessere.

**MNV001 + MNA001 | 36 x 52**  
Vaso sospeso Senza Brida  
*Wall-hung Rimless WC*

**MNB001 | 36 x 52**  
Bidet sospeso  
*Wall-hung bidet*



**MNV001 + MNA001 | 36 x 52**  
Vaso sospeso Senza Brida  
*Wall-hung Rimless WC*

**MNB001 | 36 x 52**  
Bidet sospeso  
*Wall-hung bidet*



The project stands out for its unique "squareoval" footprint and the exclusive slim wraparound toilet seat: a detail that makes an impression with its uniqueness while simultaneously offering comfort and ease. A balanced design that blends character and comfort into a visually and emotionally engaging presence.

Il progetto si distingue per la sua pianta "squareoval" e per l'esclusivo copriwater avvolgente slim: un dettaglio che colpisce per unicità, ma al tempo stesso rilassa, accoglie e mette a proprio agio. Un design bilanciato che unisce carattere e comfort in una sintesi formale dal forte impatto emotivo.

**MNV001 + MNA001 | 36 x 52**  
Vaso sospeso Senza Brida  
*Wall-hung Rimless WC*

**MNB001 | 36 x 52**  
Bidet sospeso  
*Wall-hung bidet*





A sinistra / On the left:

**MNV002 + MNA001 | 36 x 52**

Vaso terra filomuro Senza Brida  
*Back to wall Rimless WC*

**MNB002 | 36 x 52**

Bidet terra filomuro  
*Back to wall bidet*





**MNV002 + MNA001 | 36 x 52**  
Vaso terra filomuro Senza Brida  
*Back to wall Rimless WC*

**MNB002 | 36 x 52**  
Bidet terra filomuro  
*Back to wall bidet*



**MNV003 + MNA001 | 36 x 54 h 48 (PLUS)**

Vaso terra filomuro Senza Brida  
Back to wall Rimless WC

**MNB003 | 36 x 54 h 48 (PLUS)**

Bidet terra filomuro  
Back to wall bidet



**MONET**

**MNV002**

Vaso terra filomuro Senza Brida  
Back to wall Rimless WC

**MNB002**

Bidet terra filomuro  
Back to wall bidet

**MONET PLUS**

**MNV003**

Vaso terra filomuro Senza Brida  
Back to wall Rimless WC

**MNB003**

Bidet terra filomuro  
Back to wall bidet

# MONET COLLECTION DNA

Scopri le caratteristiche tecniche principali della collezione Monet  
Discover the main technical features of the Monet collection

## THE RIMLESS

Sistema di scarico senza brida: niente zone nascoste, pulizia più facile e getto uniforme per migliore igiene ed efficienza.

*Rimless flush system: no hidden areas, easier cleaning, and an even water flow for better hygiene and efficiency.*



## THE SANIGLAZE

Trattamento antibatterico ed easy-to-clean integrato nella ceramica: gli ioni attivi rendono la superficie più liscia, idrofila, brillante e resistente, con protezione certificata.

*Antibacterial, easy-to-clean treatment built into the ceramic: active ions make the surface smoother, hydrophilic, shinier, and more durable, with certified protection.*



-99,98%  
BACTERIA



## SCARICO TRASLATO

Il vaso filomuro dispone di scarico traslato. Le connessioni di scarico sono regolabili grazie agli abbinamenti delle curve con i manicotti (concentrico od eccentrici) - da acquistare separatamente.

*The back to wall WC has an adjustable flush. Drainage connections can be adjust thanks to the combinations of the curves with the pipes (concentric or eccentric) - to be purchased separately.*

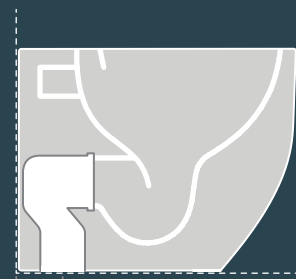

**ACA005 + ACA076** > 10 CM  
**ACA005 + ACA077** > 8/10 CM  
**ACA005 + ACA078** > 14 CM  
CURVA TECNICA S + MANICOTTO DI SCARICO A PAVIMENTO  
ELBOW AT FLOOR S + ARRANGEMENT DISCHARGE TO FLOOR

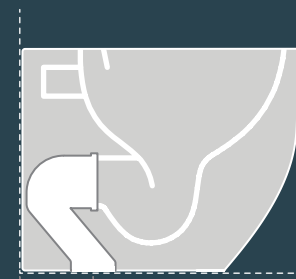

**ACA074 + ACA076** > 17 CM  
**ACA074 + ACA077** > 15/19 CM  
CURVA TECNICA TRASLATA + MANICOTTO DI SCARICO A PAVIMENTO  
ADJUSTABLE PIPE + ARRANGEMENT DISCHARGE TO FLOOR

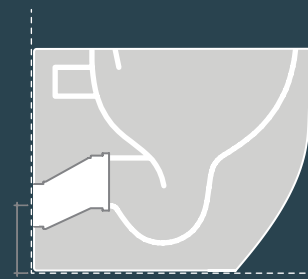

**ACA075**  
RACCORDO DI SCARICO A PARETE TRASLATO H 18 CM  
WALL TRAP ADJUSTABLE PIPE H 18 CM

## DUE DIMENSIONI

La collezione è disponibile in due varianti, Monet e Monet Plus. Monet Plus offre dimensioni maggiorate, mantenendo le stesse linee e proporzioni della collezione "madre". Il copriwater rimane lo stesso per tutti i modelli, avvolgente e ben bilanciato.

*The collection comes in two variants, Monet and Monet Plus. Monet Plus features larger dimensions while preserving the lines and proportions of the "mother" collection. The toilet seat remains the same for all models, enveloping and well balanced.*

MONET PLUS (MNV003)

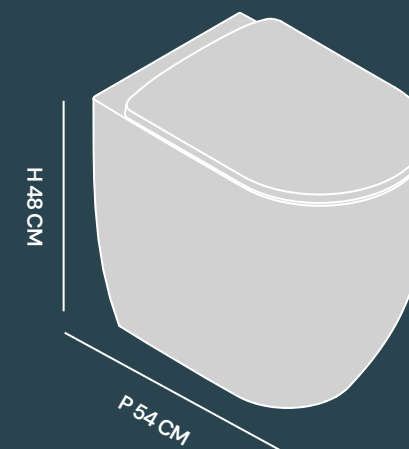

MONET (MNV002)

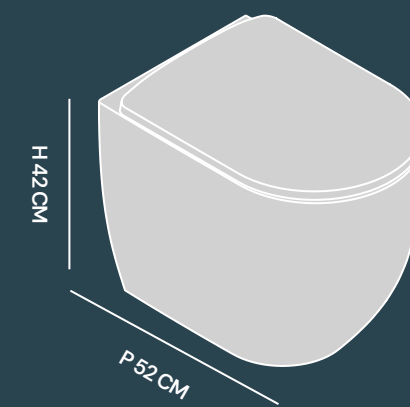

# MONET STYLES

## CLASSIC COLORS



cod. 01

bianco lucido / glossy white



cod. 05

bianco matt / matt white

# MONET OVERVIEW



THE RIMLESS

## MONET | 36 x 52

vaso sospeso Senza Brida

wall-hung Rimless WC



schede tecniche  
technical drawing

codice	colore	kg	pz. pallet Italia	pz. pallet Export	euro
--------	--------	----	-------------------	-------------------	------

CLASSIC COLORS

MNV001	○ 01; 00	22	12	20	340
MNV001	◎ 05; 00	22	12	20	480

\* kit fissaggio per sanitari sospesi obbligatorio, non incluso con il sanitario

ACA052

0,3 - - 25

mandatory fitting system kit for wall-hung sanitaryware, not included with the sanitaryware



## MONET | 36 x 52

bidet sospeso 1 foro

wall-hung bidet 1 hole



schede tecniche  
technical drawing

CLASSIC COLORS

MNB001	○ 01; 00	21	12	20	340
MNB001	◎ 05; 00	21	12	20	480

\* kit fissaggio per sanitari sospesi obbligatorio, non incluso con il sanitario

ACA052

0,3 - - 25

mandatory fitting system kit for wall-hung sanitaryware, not included with the sanitaryware

\*

Il tappo del troppopieno è coordinato al colore della ceramica, ad eccezione della versione in ceramica bianca lucida, abbinata a tappo cromo.

\*

The overflow cover is matched to the ceramic color, except for the glossy white ceramic version, which is paired with a chrome cover.

# MONET OVERVIEW



THE RIMLESS

SCARICO TRASLATO

## MONET | 36 x 52

vaso terra filomuro Senza Brida traslato, curve tecniche non incluse

back to wall Rimless Wc adjustable flush, traps not included



schede tecniche  
technical drawing

codice	colore	kg	pz. pallet Italia	pz. pallet Export	euro
CLASSIC COLORS					
MNV002	○ 01; 00	22	10	20	340
MNV002	◎ 05; 00	22	10	20	480

\* kit fissaggio laterale per sanitari obbligatorio, non incluso con il sanitario

mandatory fitting system kit for sanitaryware, not included with the sanitaryware

ACA020	0,3	-	-	15
--------	-----	---	---	----



## MONET | 36 x 52

bidet terra filomuro 1 foro

back to wall bidet 1 hole



schede tecniche  
technical drawing

codice	colore	kg	pz. pallet Italia	pz. pallet Export	euro
CLASSIC COLORS					
MNB002	○ 01; 00	21	10	20	340
MNB002	◎ 05; 00	21	10	20	480

\* kit fissaggio laterale per sanitari obbligatorio, non incluso con il sanitario

mandatory fitting system kit for sanitaryware, not included with the sanitaryware

ACA020	0,3	-	-	15
--------	-----	---	---	----

# MONET OVERVIEW



THE RIMLESS

THE SANIGLAZE

SCARICO TRASLATO

## MONET PLUS | 36 x 54 h 48

vaso terra filomuro Senza Brida traslato, con Saniglaze

back to wall Rimless wc adjustable flush, with Saniglaze



schede tecniche  
technical drawing

codice	colore	kg	pz. pallet Italia	pz. pallet Export	euro
CLASSIC COLORS					
MNV003	○ 01; 00	31	10	20	440
MNV003	◎ 05; 00	31	10	20	620

\* kit fissaggio laterale per sanitari obbligatorio, non incluso con il sanitario

mandatory fitting system kit for sanitaryware, not included with the sanitaryware

ACA020	0,3	-	-	15
--------	-----	---	---	----



THE SANIGLAZE

## MONET PLUS | 36 x 54 h 48

bidet terra filomuro, con Saniglaze

back to wall bidet, with Saniglaze



schede tecniche  
technical drawing

codice	colore	kg	pz. pallet Italia	pz. pallet Export	euro
CLASSIC COLORS					
MNB003	○ 01; 00	27	10	20	440
MNB003	◎ 05; 00	27	10	20	620

\* kit fissaggio laterale per sanitari obbligatorio, non incluso con il sanitario

mandatory fitting system kit for sanitaryware, not included with the sanitaryware

ACA020	0,3	-	-	15
--------	-----	---	---	----

# MONET OVERVIEW



## MONET

seduta per WC frizionata  
sgancio rapido

*easy take off soft-close  
WC seat*

codice	colore	kg	pz. pallet Italia	pz. pallet Export	euro
CLASSIC COLORS					
<b>MNA001</b>	○ 01; 00	3	-	-	<b>185</b>
<b>MNA001</b>	◎ 05; 00	3	-	-	<b>280</b>



## MONET

seduta per WC frizionata  
a sgancio rapido Magiclight

*easy take off soft-close  
Magiclight WC seat*

<b>MNA001</b>	○ 01; 20	3,5	-	-	<b>295</b>
---------------	----------	-----	---	---	------------

# MONET ACCESSORIES

	codice	colore	kg	pz. pallet Italia	pz. pallet Export	euro
piletta universale up & down cromo	<b>ACA032</b>		0,3	-	-	<b>75</b>
<i>chrome up &amp; down drain</i>						
piletta universale up & down con tappo in ceramica, con Saniglaze	CLASSIC COLORS					
	<b>ACA036</b>	○ 01; 34	0,3	-	-	<b>80</b>
	<b>ACA038</b>	◎ 05; 34	0,3	-	-	<b>90</b>
<i>up &amp; down universal drain with ceramic cover for washbasins, with Saniglaze</i>						
sifone ridotto - <i>reduced siphon</i>	<b>ACA021</b>		1	-	-	<b>100</b>
staffe di fissaggio per sospesi <i>fitting system kit for wall-hung</i>	<b>ACA016</b>		4	-	-	<b>70</b>
riduttore di flusso di scarico per WC <i>plug for reducing water flow</i>	<b>ACA064</b>		4	-	-	<b>15</b>
curva tecnica S <i>elbow at floor S</i>	<b>ACA005</b>		0,3	-	-	<b>25</b>
manicotto concentrico <i>concentric pipe</i>	<b>ACA076</b>		0,3	-	-	<b>20</b>
manicotto eccentrico 2 cm <i>eccentric pipe 2 cm</i>	<b>ACA077</b>		0,3	-	-	<b>20</b>
manicotto eccentrico 4 cm <i>eccentric pipe 4 cm</i>	<b>ACA078</b>		0,3	-	-	<b>25</b>
raccordo scarico parete "P" traslato <i>"P" trap adjustable pipe</i>	<b>ACA075</b>		0,3	-	-	<b>25</b>
curva tecnica traslata <i>adjustable pipe</i>	<b>ACA074</b>		0,3	-	-	<b>40</b>
protezione adesiva antirumore zig/zag <i>soundproof zig/zag</i>	<b>ACA104</b>		0,3	-	-	<b>15</b>



# HYY PE

Collezione di smart toilet  
a terra filomuro e sospesa  
scarico The.Rimless

Wall-hung and back to wall  
The.Rimless smart toilet  
collection



Scopri online  
Discover it online



# SMART TOILET COLLECTION

The smart revolution of everyday comfort.  
Hype represents a new concept of smart toilets!  
An innovating system consisting of only five elements:  
a Wc, a fixing plate, an electronic bidet, a shell,  
and a seat. A simple and revolutionary product attentive  
to the environmental impact.

# La rivoluzione smart del comfort quotidiano

Hype, un nuovo concetto di smart toilet! Un sistema innovativo, sviluppato con tecnologia HYGEA, che si compone di solo cinque elementi: il sanitario, la piastra di fissaggio, il bidet elettronico, il coperchio che lo contiene ed il sedile. Un prodotto semplice, rivoluzionario e particolarmente attento all'impatto ambientale.



**HYV002 + HYA001 | 38 x 59**

Vaso terra Senza Brida  
multi-funzione  
*Back to wall multi-function*  
*Rimless WC*

This is not a simple smart toilet since the “electronic bidet module” can be installed or replaced very easily through a cartridge that is inserted in the Wc from the top and which is totally disconnected from its shell and seat. The bidet module is the beating heart of Hype! Made using the best Korean technology, it was designed to meet the needs of demanding customers.

Non un semplice smart toilet, perché il “modulo bidet elettronico” può essere installato o sostituito molto facilmente come una cartuccia, che viene inserita nel sanitario dall’alto ed è completamente scollegato dal suo involucro e dal sedile. In HYPE il bidet elettronico è il cuore pulsante! Realizzato con la migliore tecnologia coreana, è studiato per soddisfare le richieste dei clienti più esigenti.

# HYPE COMPONENTS



**HYV001 + HYA001 | 38 x 59**

Vaso sospeso Senza Brida  
multi-funzione  
*Wall-hung multi-function  
Rimless WC*



# HYPE FEATURES

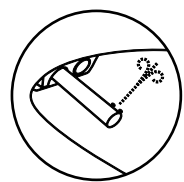

igiene posteriore  
posterior cleansing

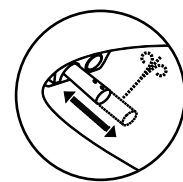

movimento oscillante ugello  
oscillating nozzle

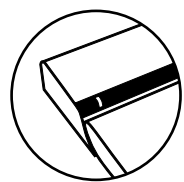

LED di notifica  
operational LED

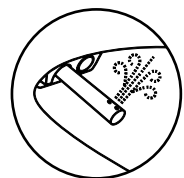

igiene femminile  
feminine cleansing

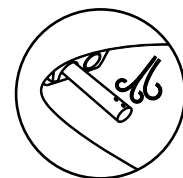

pulizia automatica ugello  
automatic cleansing of the nozzle

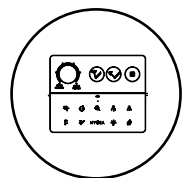

telecomando  
remote control



igiene bambini  
"kids" function

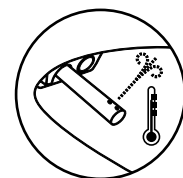

temperatura acqua regolabile  
warm water with variable  
temperature setting

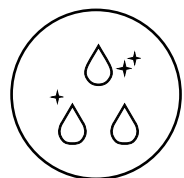

programma anticalcare  
anti-lime program

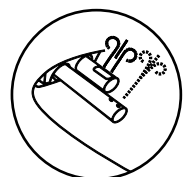

funzione "auto" (igiene+asciugatura)  
"auto" function (hygiene+dryer)

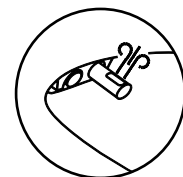

asciugatura (2 int. 5 livelli di temp.)  
air drying (2 int. 5 temp. levels)

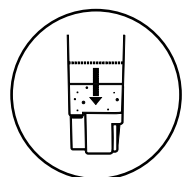

svuotamento automatico tanica  
automatic draining of the tank

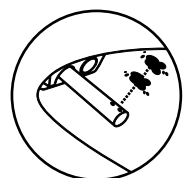

getto a intensità variabile  
variable spray



2 memorie utente  
user's memories: 2

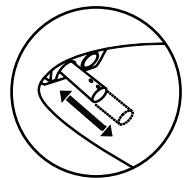

posizione ugello regolabile  
position of the nozzle variable

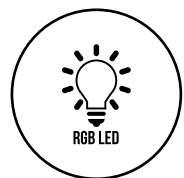

luce di cortesia intensità variabile  
dimming courtesy light

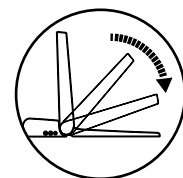

chiusura rallentata  
soft closing

# HYPE CONTROLLER

Le funzioni sono state accuratamente selezionate ed ottimizzate per fornire la miglior esperienza possibile.

Un ugello in acciaio inossidabile provvede all'igiene intima, mentre l'asciugatura viene effettuata da un dispositivo ad alta efficienza. La funzione "svuotamento automatico della tanica" e il programma anticalcare assicurano maggior igiene ed affidabilità. Particolare attenzione anche al risparmio idrico, perchè il suo sistema di scarico utilizza solamente 3,5 litri di acqua!

*Functions have been accurately selected and optimized to provide best possible experience.*

*A stainless steel nozzle provide personal hygiene while the drying is carried out through a high-performance device. The "automatic emptying of tank" function and anti-limescale program ensure the best hygiene and reliability. Particular attention has been paid to water saving solutions resulting in a flushing system that uses only 3.5 litres of water!*





# HYPE COLLECTION DNA

Scopri le caratteristiche tecniche principali della collezione Hype  
*Discover the main technical features of the Hype collection*

## THE. RIMLESS

Sistema di scarico senza brida: niente zone nascoste, pulizia più facile e getto uniforme per migliore igiene ed efficienza.

*Rimless flush system: no hidden areas, easier cleaning, and an even water flow for better hygiene and efficiency.*



Guarda il video  
Watch the video

## THE. SANIGLAZE

Trattamento antibatterico ed easy-to-clean integrato nella ceramica: gli ioni attivi rendono la superficie più liscia, idrofila, brillante e resistente, con protezione certificata.

*Antibacterial, easy-to-clean treatment built into the ceramic: active ions make the surface smoother, hydrophilic, shinier, and more durable, with certified protection.*



-99,98%  
BACTERIA



# HYPE STYLES

## CLASSIC COLORS



cod. 01

bianco lucido / glossy white



cod. 05

bianco matt / matt white

# HYPE OVERVIEW



THE RIMLESS

THE SANIGLAZE

## HYPE | 38 x 59

vaso sospeso Senza Brida multi-funzione + kit di fissaggio, con Saniglaze

wall-hung multi-function Rimless WC + fitting system kit, with Saniglaze



schede tecniche  
technical drawing

codice	colore	kg	pz. pallet Italia	pz. pallet Export	euro
CLASSIC COLORS					
HYV001	○ 01; 00	23	6	9	800
HYV001	◎ 05; 00	23	6	9	1100



THE RIMLESS

THE SANIGLAZE

## HYPE | 38 x 59

vaso terra filomuro Senza Brida multi-funzione + kit di fissaggio, con Saniglaze

back to wall multi-function Rimless WC + fitting system kit, with Saniglaze



schede tecniche  
technical drawing

codice	colore	kg	pz. pallet Italia	pz. pallet Export	euro
CLASSIC COLORS					
HYV002	○ 01; 00	23	6	9	900
HYV002	◎ 05; 00	23	6	9	1200



# HYPE OVERVIEW

	codice	colore	kg	pz. pallet Italia	pz. pallet Export	euro
<b>HYPE</b>	CLASSIC COLORS					
sedile rallentato	HYA001	○ 01; 71	3	6	9	150
multi-functions soft-close seat	HYA001	◎ 05; 71	3	6	9	450

<b>HYPE</b>	HYA001	○ 01; 20	3,5	-	-	295
seduta per WC frizionata a sgancio rapido Magiclight						
easy take off soft-close Magiclight WC seat						

<b>HYPE</b>	CLASSIC COLORS					
modulo elettronico con telecomando	HYA002	○ 01;	3,5	6	9	1900
electronic module with remot control	HYA002	◎ 05;	3,5	6	9	2350

<b>HYPE</b>	HYA003		1,5	6	9	170
accessori installazione installation accessories						

# CIVITAS



Scopri online  
Discover it online



Collezione di sanitari a terra,  
filomuro, sospesi e monoblocco  
con lavabi coordinati  
e strutture dedicate

Wall-hung, back to wall  
and close-coupled sanitaryware  
collection, with coordinated  
washbasins and dedicated  
structures

## SANITARYWARE, WASHBASINS & STRUCTURES COLLECTION

Minimal-Retro: the meeting of eras.  
Civitas restyles the conception of the classical column,  
supporting architectural icon, by refining it and making  
it much more contemporary compared to what is known  
in the ceramic field.

# Minimal-Retró: l'incontro tra epoche.

Civitas ridisegna il modello  
della colonna classica, icona  
architettonica portante, dandone  
una versione dal design raffinato  
e contemporaneo, applicato alla  
ceramica sanitaria. Curve e superfici  
ben proporzionate definiscono  
lo spazio in verticale.

**CIL001 + CIC001 | 68 x 50**

Lavabo + colonna  
Washbasin + column

**CIV002 + CIA010 | 36 x 54**

Vaso terra  
Wc with floor drain

**CIB002 | 36 x 54**

Bidet terra  
Floor bidet



CIL001 + CIC001 | 68 x 50

Lavabo + colonna

Washbasin + column



Balanced lines and surfaces define the vertical space. The octagonal base is characterized by smooth, shaped lines decorating the ceramic column which is the hallmark of this collection topped with a smooth oval basin. Past values and tradition are at the base of this evergreen collection.

La base di forma ottagonale è caratterizzata da fasce sagomate lisce con funzione decorativa a sostegno della colonna in ceramica, vero elemento caratterizzante la collezione, su cui è appoggiato il morbido catino ovale. Un progetto ispirato ai valori della memoria e della tradizione, per una collezione senza tempo.

**CIV002 + CIA010 | 36 x 54**

Vaso terra  
Wc with floor drain

**CIB002 | 36 x 54**

Bidet terra  
Floor bidet



**CIL002 + CIC002 | 90 x 50**  
Consolle + gambe in ceramica  
*Consolle + ceramic legs*



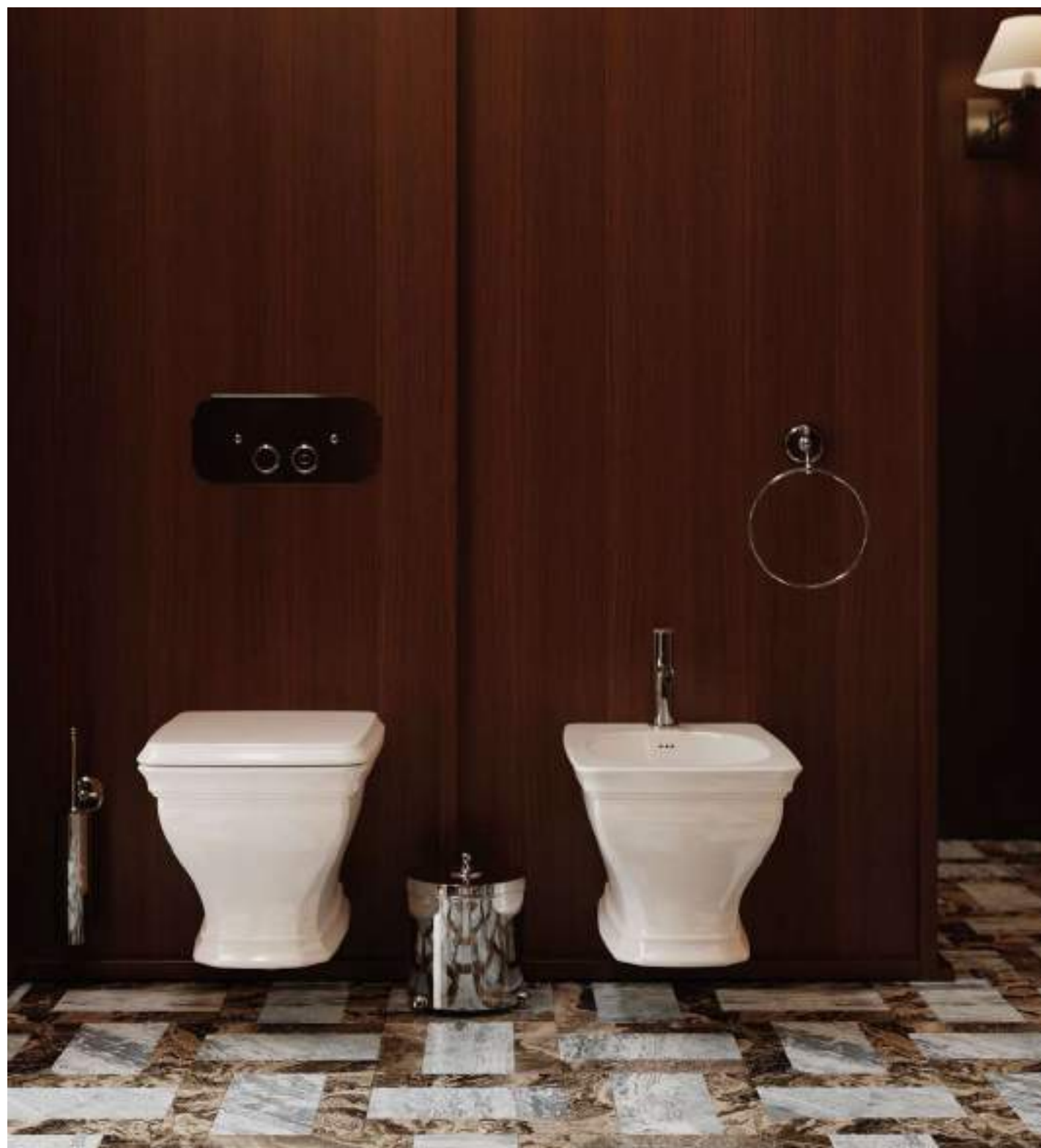

**CIV001 + CIA010 | 36 x 54**

Vaso sospeso  
Wall-hung wc

**CIB001 | 36 x 54**

Bidet sospeso  
Wall-hung bidet



**CIL002 + CIA005 | 90 x 50**

Consolle + struttura Quadra  
con griglia  
Consolle + Quadra structure  
with grate shelf



## CIVITAS SYSTEM

I lavabi Civitas possono essere completati da pratiche strutture metalliche pensate ad hoc!  
La struttura Quadra nasce dalla necessità di aggiornare il linguaggio estetico di questo elemento, non una semplice variazione decorativa o formale, ma una vera e propria innovazione paradigmatica. Lo studio fatto sul giunto pressofuso permette di avere diverse tipologie di "allestimento" e di dimensioni, un design ricercato e non banale per una collezione dall'estrema semplicità compositiva che risolve con originalità le più svariate esigenze funzionali.

*Civitas washbasins are completed by practical ad-hoc metal structures! The Quadra structure was designed to update the aesthetical language of this element, not just through a simple decorative and formal variation but through an exemplary innovation. The careful study on die cast joint allows to have various types of fittings and dimensions, not a trivial idea but a refined design on a collection characterized by an extremely simple composition that aims to originally meet any functional demand.*

### QUADRA STRUCTURE

L. 68 - 90 cm

vuota / empty



con griglia / with grate shelf



con vetro / with glass



# CIVITAS SYSTEM

Con un design studiato più classico e discreto, la struttura Tonda appare maggiormente slanciata grazie alla conformazione delle gambe. Questa seconda variante creata per le strutture Civitas è disponibile solo sulla consolle 90. Le diverse configurazioni sono ottenute mediante semplice piegatura del tubolare metallico, che è elemento strutturale ma anche pratico portasciugamani integrato.

La struttura si completa con un piano di appoggio inferiore, disponibile in vetro o griglia; e come la precedente è declinata nelle 3 varianti cromatiche metalliche a disposizione.

*Thanks to a refined and discrete careful study, the Tonda structure has a sleek look due to the shape of its legs. This alternative solution of Civitas structures is available only for the consolle 90. The various setups can be obtained through the bending of the metal tube which is a structural element turning into a practical integrated towel holder. The structure is completed by a bottom top, glass or metal grid; like the other structures, 3 different metal colours are available.*



## METALS



cromato  
chrome  
cod. 71



oro rosa  
pink gold  
cod. 77



oro  
gold  
cod. 73

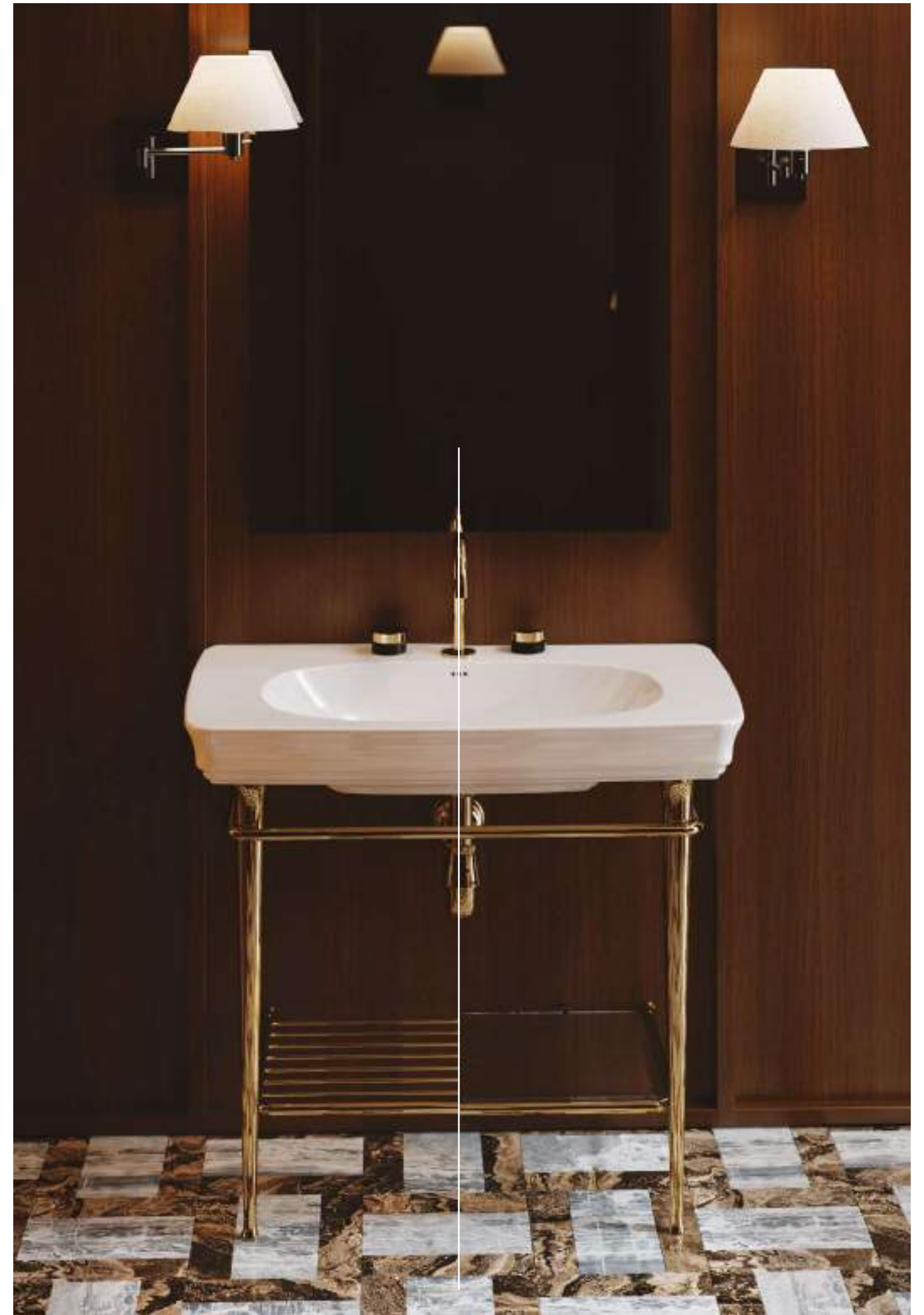

**CIV004 + CIC007 | 36 x 54**

Vaso monoblocco  
con cassetta a zaino  
Wc with low ceramic cistern

**CIB002 | 36 x 54**

Bidet terra  
Floor bidet



**CIV004 + CIC009 | 36 x 54**

Vaso monoblocco  
con scarico universale  
Wc with universal drain

**CIB002 | 36 x 54**

Bidet terra  
Floor bidet

# CIVITAS STYLES

## CLASSIC COLORS



cod. 01

bianco lucido / glossy white

## METALS



cod. 71

cromato / chrome



cod. 77

oro rosa / pink gold



cod. 73

oro / gold

# CIVITAS OVERVIEW



## CIVITAS | 36 x 54

codice	colore	kg	pz. pallet Italia	pz. pallet Export	euro
CIV001	○ 01; 00	21	12	20	460

vaso sospeso

wall-hung WC



schede tecniche  
technical drawing

\* kit fissaggio per sanitari sospesi obbligatorio, non incluso con il sanitario

ACA052

0,3 - - 25

*mandatory fitting system kit for wall-hung sanitaryware, not included with the sanitaryware*



## CIVITAS | 36 x 54

codice	colore	kg	pz. pallet Italia	pz. pallet Export	euro
CIB001	○ 01; 00	18	12	20	460

bidet sospeso solo 1 foro

wall-hung WC just 1 hole



schede tecniche  
technical drawing

\* kit fissaggio per sanitari sospesi obbligatorio, non incluso con il sanitario

ACA052

0,3 - - 25

*mandatory fitting system kit for wall-hung sanitaryware, not included with the sanitaryware*



## CIVITAS | 36 x 54

codice	colore	kg	pz. pallet Italia	pz. pallet Export	euro
CIV002	○ 01; 00	19	10	15	460

vaso terra scarico "S"

WC with floor drain



schede tecniche  
technical drawing

# CIVITAS OVERVIEW



## CIVITAS | 36 x 54

codice	colore	kg	pz. pallet Italia	pz. pallet Export	euro
CIV003	○ 01; 00	19	10	15	460

vaso terra scarico "P"

WC with wall drain



schede tecniche  
technical drawing



## CIVITAS | 36 x 54

codice	colore	kg	pz. pallet Italia	pz. pallet Export	euro
CIB002	○ 01; 00	18	10	15	460

bidet terra 1 foro  
(predisposto tre fori)

floor bidet 1 hole  
with arrangement for 3 holes



schede tecniche  
technical drawing



## CIVITAS | 36 x 54

codice	colore	kg	pz. pallet Italia	pz. pallet Export	euro
CIV004	○ 01; 00	22	6	12	550

vaso monoblocco  
con scarico universale

WC with universal drain



schede tecniche  
technical drawing

# CIVITAS OVERVIEW



## CIVITAS | 44 x 39

codice	colore	kg	pz. pallet Italia	pz. pallet Export	euro
CIC009	○ 01; 00	14	-	-	250

cassetta monoblocco  
con coperchio

ceramic cistern with cover

meccanismo di scarico universale  
con pulsante doppio flusso, cromo,  
oro rosa, oro

double flow discharge  
with button, standard valve  
mechanism, chrome,  
rose gold, gold

METALS

HEA010	● 71	1	-	-	105
HEA010	● 77	1	-	-	130
HEA010	● 73	1	-	-	130



## CIVITAS | 44 x 39

codice	colore	kg	pz. pallet Italia	pz. pallet Export	euro
CIC007	○ 01; 00	14	-	-	250

cassetta a zaino con coperchio,  
predisposizione per maniglia

low level ceramic cistern with cover  
pre-arranged for handle



schede tecniche  
technical drawing

meccanismo scarico  
con maniglia frontale e tubo  
esterno di scarico  
in cromo, oro rosa, oro

flushing system with front  
handle and flush pipe in chrome,  
rose gold, gold

METALS

HEA013	● 71	1	-	-	480
HEA013	● 77	1	-	-	600
HEA013	● 73	1	-	-	600

# CIVITAS OVERVIEW



	codice	colore	kg	pz. pallet Italia	pz. pallet Export	euro
<b>CIVITAS   44 X 39</b>	<b>CIC006</b>	○ 01; 00	14	-	-	250

cassetta alta con coperchio

*high ceramic cistern with cover*



schede tecniche  
technical drawing

meccanismo di scarico  
con maniglia in ceramica, catenella  
e tubo esterno  
cromo, oro rosa, oro

METALS

<b>HEA006</b>	● 71	1	-	-	480
<b>HEA006</b>	● 77	1	-	-	600
<b>HEA006</b>	● 73	1	-	-	600

*flushing system, with ceramic pull,  
chain and flush pipe  
in chrome, rose gold, gold*

pomello ceramica  
per meccanismo di scarico  
HEA013/HEA006

<b>ACA063</b>	○ 01; 00	-	-	-	50
---------------	----------	---	---	---	----

ceramic knob for flushing  
system HEA013/HEA006

# CIVITAS OVERVIEW



	codice	colore	kg	pz. pallet Italia	pz. pallet Export	euro
<b>CIVITAS</b>	<b>CIA010</b>	● 01; 71	3	-	-	185

seduta per WC frizionata,  
cerniera cromo

*soft-close WC seat,  
chrome hinge*

seduta per WC frizionata, cerniera oro rosa	<b>CIA010</b>	● 01; 77	3	-	-	280
--	---------------	----------	---	---	---	-----

*soft-close WC seat,  
rose gold hinge*

seduta per WC frizionata, cerniera oro	<b>CIA010</b>	● 01; 73	3	-	-	280
---	---------------	----------	---	---	---	-----

*soft-close WC seat,  
gold hinge*

# CIVITAS OVERVIEW



## CIVITAS | 68 x 50

lavabo sospeso/da colonna  
1 foro (predisposto 3 fori)

wall-hung/for column  
washbasin 1 hole with arrangements  
for 3 holes

codice	colore	kg	pz. pallet Italia	pz. pallet Export	euro
CIL001	○ 01; 00	20	16	24	395



schede tecniche  
technical drawing

\* tasselli per fissaggio lavabi  
sospesi, non inclusi con il lavabo

ACA007		0,3	-	-	15
--------	--	-----	---	---	----

fitting system kit for wall-hung  
washbasins, not included  
with the washbasin



## CIVITAS

colonna per lavabo 68

column for washbasin 68

CIC001	○ 01; 00	12	14	27	250
--------	----------	----	----	----	-----



## CIVITAS | 90 x 50

consolle 1 foro  
(predisposto tre fori)

consolle 1 hole  
with arrangement for 3 holes

CIL002	○ 01; 00	25	8	9	560
--------	----------	----	---	---	-----



schede tecniche  
technical drawing

\* tasselli per fissaggio lavabi  
sospesi, non inclusi con il lavabo

ACA007		0,3	-	-	15
--------	--	-----	---	---	----

fitting system kit for wall-hung  
washbasins, not included  
with the washbasin



## CIVITAS

coppia gambe ceramica

pair of ceramic legs

CIC002	○ 01; 00	13	-	-	415
--------	----------	----	---	---	-----

# CIVITAS OVERVIEW



## CIVITAS

struttura Tonda per consolle 90,  
cromo, oro rosa, oro + griglia

Tonda structure for consolle 90,  
chrome, rose gold, gold + grate  
shelf

codice	colore	kg	pz. pallet Italia	pz. pallet Export	euro
CIA008	● 71	14	-	-	1860
CIA008	● 77	14	-	-	2420
CIA008	● 73	14	-	-	2420



schede tecniche  
technical drawing



## CIVITAS

struttura Tonda per consolle 90,  
cromo, oro rosa, oro + vetro

Tonda structure for consolle 90,  
chrome, rose gold, gold + glass

codice	colore	kg	pz. pallet Italia	pz. pallet Export	euro
CIA009	● 71	14	-	-	1720
CIA009	● 77	14	-	-	2120
CIA009	● 73	14	-	-	2120



schede tecniche  
technical drawing



## CIVITAS

struttura Quadra per lavabo 68,  
cromo, oro rosa, oro

Quadra structure for washbasin 68,  
chrome, rose gold, gold

codice	colore	kg	pz. pallet Italia	pz. pallet Export	euro
CIA001	● 71	12	-	-	1460
CIA001	● 77	12	-	-	1720
CIA001	● 73	12	-	-	1720



schede tecniche  
technical drawing



## CIVITAS

struttura Quadra per lavabo 68,  
cromo, oro rosa, oro + griglia

Quadra structure for washbasin  
68, chrome, rose gold, gold + grate  
shelf

codice	colore	kg	pz. pallet Italia	pz. pallet Export	euro
CIA002	● 71	14	-	-	1980
CIA002	● 77	14	-	-	2520
CIA002	● 73	14	-	-	2520



schede tecniche  
technical drawing

# CIVITAS OVERVIEW



## CIVITAS

struttura Quadra per lavabo 68,  
cromo, oro rosa, oro + vetro

*Quadra structure for washbasin 68,  
chrome, rose gold, gold + glass*

codice	colore	kg	pz. pallet Italia	pz. pallet Export	euro
METALS					
CIA003	71	14	-	-	1720
CIA003	77	14	-	-	2120
CIA003	73	14	-	-	2120



schede tecniche  
technical drawing



## CIVITAS

struttura Quadra per consolle 90,  
cromo, oro rosa, oro

*Quadra structure for consolle 90,  
chrome, rose gold, gold*

codice	colore	kg	pz. pallet Italia	pz. pallet Export	euro
METALS					
CIA004	71	14	-	-	1460
CIA004	77	14	-	-	1860
CIA004	73	14	-	-	1860



schede tecniche  
technical drawing



## CIVITAS

struttura Quadra per consolle 90,  
cromo, oro rosa, oro + griglia

*Quadra structure for consolle 90,  
chrome, rose gold, gold + grate  
shelf*

codice	colore	kg	pz. pallet Italia	pz. pallet Export	euro
METALS					
CIA005	71	16	-	-	2120
CIA005	77	16	-	-	2620
CIA005	73	16	-	-	2620



schede tecniche  
technical drawing



## CIVITAS

struttura Quadra per consolle 90,  
cromo, oro rosa, oro + vetro

*Quadra structure for consolle 90,  
chrome, rose gold, gold + glass*

codice	colore	kg	pz. pallet Italia	pz. pallet Export	euro
METALS					
CIA006	71	16	-	-	1720
CIA006	77	16	-	-	2260
CIA006	73	16	-	-	2260



schede tecniche  
technical drawing

# CIVITAS ACCESSORIES

	codice	colore	kg	pz. pallet Italia	pz. pallet Export	euro
piletta universale up & down cromo	ACA032		0,3	-	-	75
<i>chrome up &amp; down drain</i>						



piletta universale lavabo  
up & down tappo in ceramica,  
con Saniglaze

ACA036 01; 34 0,3 - - 80

*up & down universal drain  
with ceramic cover  
for washbasins, with Saniglaze*

sifone cilindrico cromo <i>chrome siphon</i>	ACA022		1	-	-	130
---	--------	--	---	---	---	-----

sifone ridotto - <i>reduced siphon</i>	ACA021		1	-	-	100
--	--------	--	---	---	---	-----

staffe di fissaggio per sospesi <i>fitting system kit for wall-hung</i>	ACA016		4	-	-	70
--	--------	--	---	---	---	----

protezione adesiva antirumore zig/zag <i>soundproof zig/zag</i>	ACA104		0,3	-	-	15
---	--------	--	-----	---	---	----

# HER MITA GE

Collezione di sanitari a terra,  
filomuro, sospesi e monoblocco  
con lavabi coordinati  
e strutture dedicate

Wall-hung, back to wall  
and close-coupled sanitaryware  
collection, with coordinated  
washbasins and dedicated  
structures



Scopri online  
Discover it online



## SANITARYWARE, WASHBASINS & STRUCTURES COLLECTION

Baroque hints.  
Hermitage evokes a sense of security and stability, inspiring confidence through a design that transcends time. Its harmonious shapes recall evocative, bygone atmospheres, enriched with stylistic references – at times almost baroque – that define a refined and timeless elegance. A true classic that brings back the charm of the 19th century, Hermitage expresses its full potential in interiors with a strong classical soul, where soft proportions and decorative details dialogue with stylistic elements of the past, making it unexpectedly contemporary.

# Citazioni barocche.

Hermitage evoca un senso di sicurezza e stabilità, ispirando fiducia attraverso un design che sfugge al tempo. Le sue forme armoniose richiamano atmosfere d'antan, con citazioni stilistiche – talvolta quasi barocche – che definiscono un'eleganza ricercata e senza tempo. Un grande classico che rievoca la raffinatezza dell'Ottocento, Hermitage trova la sua massima espressione negli ambienti dalla forte anima classica, dove proporzioni morbide e dettagli decorativi dialogano con gli stilemi del passato rendendola sorprendentemente attuale.

**HELO02 + HEC002 | 68 x 55**

Lavabo con colonna  
Washbasin with column

**HEV002 + HEC004 + HEA005 | 36 x 55**

Vaso terra scarico "S" Senza Brida  
con cassetta alta con coperchio  
Rimless WC with floor drain  
with high ceramic cistern with cover

**HEB002 | 36 x 55**

Bidet terra  
Floor bidet



HELOO2 + HEC002 | 68 x 55

Lavabo con colonna  
Washbasin with column



Its pure, balanced lines allow the collection to blend naturally even into more modern settings, adding a touch of character and charm. The series includes, in addition to sanitaryware available in various installation types, washbasins with pedestal or dedicated structures, enhanced by fine details and coordinated accessories. Elegant lines, baroque references and timeless beauty make Hermitage the ideal choice for those who seek a classic, welcoming and characterful bathroom environment.

SANITARYWARE

La sua purezza formale permette alla collezione di inserirsi con naturalezza anche in contesti più contemporanei, portando un tocco di charme e personalità. La serie comprende, oltre ai sanitari disponibili in diverse tipologie di installazione, anche lavabi con colonna o con strutture dedicate, arricchiti da dettagli pregiati e accessori coordinabili. Linee eleganti, citazioni barocche e una bellezza senza tempo rendono Hermitage la scelta ideale per chi desidera un bagno classico, accogliente e ricco di carattere.

**HEV002 + HEC004 + HEA005 | 36 x 55**

Vaso terra scarico "S" Senza Brida  
con cassetta alta con coperchio  
*Rimless WC with floor drain  
with high ceramic cistern with cover*

**HEB002 | 36 x 55**

Bidet terra  
*Floor bidet*





**HEL004 + HEC003 | 112 x 63**

Consolle 1 foro con gambe ceramica  
*Console 1 hole with pair of ceramic legs*



**HEV010 + HEA005 | 36 x 55**

Vaso sospeso  
Wall-hung WC

**HEB003 | 36 x 55**

Bidet sospeso  
Wall-hung bidet





A sinistra / On the left:

**HEV002 + HEA005 | 36 x 55**

Vaso terra scarico "S" Senza Brida  
*Rimless WC with floor drain*

**HEB002 | 36 x 55**

Bidet terra  
*Floor bidet*



**HEW001 | 170 x 80 h 72**

Vasca bianca  
con accessori metallici cromo  
*White bathroom  
with metal chrome accessories*





A sinistra / On the left:

**HEV006 + HEA005 + HEC009 | 36 x 71**

Vaso monoblocco filomuro  
con cassetta con coperchio  
*Back to wall close-coupled WC  
with ceramic cistern*

**HEB001 | 36 x 55**

Bidet terra filomuro  
*Back to wall bidet*

**HEV005 + HEA005 | 36 x 55**

Vaso terra filomuro  
*Back to wall WC*

**HEB001 | 36 x 55**

Bidet terra filomuro  
*Back to wall bidet*



# HERMITAGE COLLECTION DNA

Scopri le caratteristiche tecniche principali della collezione Hermitage  
Discover the main technical features of the Hermitage collection

## THE RIMLESS

Sistema di scarico senza brida: niente zone nascoste, pulizia più facile e getto uniforme per migliore igiene ed efficienza.

*Rimless flush system: no hidden areas, easier cleaning, and an even water flow for better hygiene and efficiency.*



## HERMITAGE STYLES

### CLASSIC COLORS



cod. 01

bianco lucido / glossy white

### METALS



cod. 76

bianco lucido / glossy white



cod. 71

cromato / chrome



cod. 72

bronzo / bronze



cod. 73

oro / gold

# HERMITAGE OVERVIEW



### HERMITAGE | 36 x 55

codice	colore	kg	pz. pallet Italia	pz. pallet Export	euro
HEV010	01; 00	21	15	20	405

vaso sospeso

wall-hung WC



schede tecniche  
technical drawing

\* kit fissaggio per sanitari sospesi obbligatorio, non incluso con il sanitario

ACA052

0,3 - - 25

*mandatory fitting system kit for wall-hung sanitaryware, not included with the sanitaryware*



### HERMITAGE | 36 x 55

codice	colore	kg	pz. pallet Italia	pz. pallet Export	euro
HEB003	01; 00	18	15	20	405

bidet sospeso solo 1 foro

wall-hung bidet just 1 hole



schede tecniche  
technical drawing

\* kit fissaggio per sanitari sospesi obbligatorio, non incluso con il sanitario

ACA052

0,3 - - 25

*mandatory fitting system kit for wall-hung sanitaryware, not included with the sanitaryware*

THE RIMLESS



### HERMITAGE | 36 x 55

codice	colore	kg	pz. pallet Italia	pz. pallet Export	euro
HEV002	01; 00	29	15	20	405

vaso terra scarico "S" senza Brida

Rimless WC with floor drain



schede tecniche  
technical drawing

vaso terra scarico "P" senza Brida

Rimless WC with wall drain

codice	colore	kg	pz. pallet Italia	pz. pallet Export	euro
HEV003	01; 00	29	15	20	405

\* kit fissaggio verticale per sanitari obbligatorio, non incluso con il sanitario

ACA103

0,3 - - 15

*mandatory fitting system kit for sanitaryware, not included with the sanitaryware*

# HERMITAGE OVERVIEW

# HERMITAGE OVERVIEW



## HERMITAGE | 36 x 55

bidet terra 1 foro (predisposto 3 fori)

floor bidet 1 hole with arrangement for 3 holes

codice	colore	kg	pz. pallet Italia	pz. pallet Export	euro
HEB002	01; 00	24	15	20	405



schede tecniche technical drawing

\* kit fissaggio verticale per sanitari obbligatorio, non incluso con il sanitario

ACA103	0,3	-	-	15
--------	-----	---	---	----

mandatory fitting system kit for sanitaryware, not included with the sanitaryware



## HERMITAGE | 36 x 55

vaso terra filomuro + raccordo di scarico

back to wall WC + pipe

HEV005	01; 00	22	10	20	440
--------	--------	----	----	----	-----



schede tecniche technical drawing

\* kit fissaggio laterale per sanitari obbligatorio, non incluso con il sanitario

ACA020	0,3	-	-	15
--------	-----	---	---	----

mandatory fitting system kit for sanitaryware, not included with the sanitaryware



## HERMITAGE | 36 x 55

bidet terra filomuro solo 1 foro

back to wall bidet just 1 hole

HEB001	01; 00	19	10	20	440
--------	--------	----	----	----	-----



schede tecniche technical drawing

\* kit fissaggio laterale per sanitari obbligatorio, non incluso con il sanitario

ACA020	0,3	-	-	15
--------	-----	---	---	----

mandatory fitting system kit for sanitaryware, not included with the sanitaryware



## HERMITAGE | 36 x 71

vaso monoblocco con scarico P senza Brida

close-coupled Rimless Wc with wall drain

codice	colore	kg	pz. pallet Italia	pz. pallet Export	euro
HEV004	01; 00	22	8	12	470



schede tecniche technical drawing

vaso monoblocco con scarico S

HEV008	01; 00	22	8	12	470
--------	--------	----	---	----	-----

close-coupled Wc with floor drain

\* kit fissaggio verticale per sanitari obbligatorio, non incluso con il sanitario

ACA103	0,3	-	-	15
--------	-----	---	---	----

mandatory fitting system kit for sanitaryware, not included with the sanitaryware



## HERMITAGE | 36 x 55

cassetta monoblocco

ceramic cistern

HEC001	01; 00	14	-	-	240
--------	--------	----	---	---	-----

meccanismo di scarico universale con pulsante doppio flusso, cromo, bronzo, oro

METALS

HEA010	71	5	-	-	105
--------	----	---	---	---	-----

HEA010	72	5	-	-	130
--------	----	---	---	---	-----

HEA010	73	5	-	-	130
--------	----	---	---	---	-----

double flow discharge with button, standard valve mechanism, chrome, rose gold, gold



## HERMITAGE | 36 x 71

vaso monoblocco filomuro + raccordo di scarico

back to wall close-coupled WC + pipe

HEV006	01; 00	34	6	9	570
--------	--------	----	---	---	-----



schede tecniche technical drawing

\* kit fissaggio laterale per sanitari obbligatorio, non incluso con il sanitario

ACA020	0,3	-	-	15
--------	-----	---	---	----

mandatory fitting system kit for sanitaryware, not included with the sanitaryware

# HERMITAGE OVERVIEW



**HERMITAGE | 36 x 55**      HEC009 ○ 01; 00 11 15 20 240

cassetta monoblocco filomuro con coperchio

*ceramic cistern*

cisterna in pvc con dispositivo di scarico doppio flusso geberit, in cromo, bronzo, oro

*geberit plastic cistern with waste system double flow, in chrome, bronze, gold*

METALS		kg	pz. pallet Italia	pz. pallet Export	euro
ACA006	71	5	-	-	220
ACA006	72	5	-	-	255
ACA006	73	5	-	-	255

**HERMITAGE | 36 x 55**      HEC004 ○ 01; 00 14 - - 240

cassetta alta con coperchio

*high ceramic cistern with cover*

batteria scarico, maniglia in ceramica con catenella e tubo scarico esterno, in cromo, bronzo, oro

*flushing system, with ceramic pull, chain and flush pipe, in chrome, bronze, gold*



schede tecniche  
technical drawing

pomello ceramica per meccanismo di scarico HEA013/HEA006      ACA063 ○ 01; 00 - - - 50

*ceramic knob for flushing system HEA013/HEA006*

# HERMITAGE OVERVIEW



**HERMITAGE | 42 x 41**      HEC005 ○ 01; 00 14 - - 240

cassetta a zaino con coperchio predisposizione per maniglia

*low level ceramic cistern with cover pre-arranged for handle*

meccanismo scarico con maniglia in ceramica frontale e tubo esterno di scarico, in cromo, bronzo, oro

*flushing system with front ceramic handle and flush pipe, in chrome, bronze, gold*



schede tecniche  
technical drawing

METALS		kg	pz. pallet Italia	pz. pallet Export	euro
HEA013	71	-	-	-	480
HEA013	72	-	-	-	600
HEA013	73	-	-	-	600

# HERMITAGE OVERVIEW

# HERMITAGE OVERVIEW



## HERMITAGE | 36 x 55

codice	colore	kg	pz. pallet Italia	pz. pallet Export	euro
HEA005	01; 71	3,5	-	-	195

seduta per WC frizionata a sgancio rapido, cerniera cromo

*easy take off soft-close WC seat, chrome hinge*

seduta per WC frizionata a sgancio rapido, cerniera bronzo

HEA005	01; 72	3,5	-	-	240
--------	--------	-----	---	---	-----

*easy take off soft-close WC seat, bronze hinge*

seduta per WC frizionata a sgancio rapido, cerniera oro

HEA005	01; 73	3,5	-	-	240
--------	--------	-----	---	---	-----

*easy take off soft-close WC seat, gold hinge*



## HERMITAGE | 36 x 55

HEA004	71	3,5	-	-	285
--------	----	-----	---	---	-----

seduta per WC in noce massello frizionata a sgancio rapido, cerniera cromo

*easy take off soft-close walnut wood WC seat, chrome hinge*

seduta per WC in noce massello frizionata a sgancio rapido, cerniera bronzo

HEA004	72	3,5	-	-	295
--------	----	-----	---	---	-----

*easy take off soft-close walnut wood WC seat, bronze hinge*

seduta per WC in noce massello frizionata a sgancio rapido, cerniera oro

HEA004	73	3,5	-	-	295
--------	----	-----	---	---	-----

*easy take off soft-close walnut wood WC seat, gold hinge*



## HERMITAGE | 68 x 55

codice	colore	kg	pz. pallet Italia	pz. pallet Export	euro
HEL002	01; 00	24	12	16	390

lavabo 1 foro (predisposto 3 fori) + kit di fissaggio

*washbasin 1 hole with arrangement for 3 holes + fitting system kit*



schede tecniche  
technical drawing



## HERMITAGE

HEC002	01; 00	12	14	27	240
--------	--------	----	----	----	-----

colonna per lavabo 68

*column for washbasin 68*



## HERMITAGE | 92 x 58

HEL005	01; 00	41	8	9	515
--------	--------	----	---	---	-----

consolle 1 foro (predisposto 3 fori) + kit di fissaggio

*consolle 1 hole with arrangement for 3 holes + fitting system kit*



schede tecniche  
technical drawing



## HERMITAGE | 112 x 63

HEL004	01; 00	49	6	7	540
--------	--------	----	---	---	-----

consolle 1 foro (predisposto 3 fori) + kit di fissaggio

*consolle 1 hole with arrangement for 3 holes + fitting system kit*



schede tecniche  
technical drawing

# HERMITAGE OVERVIEW

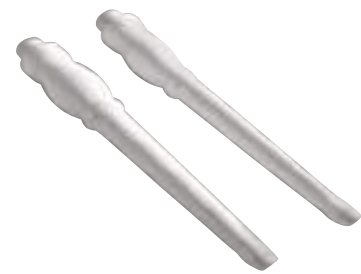

codice	colore	kg	pz. pallet Italia	pz. pallet Export	euro
<b>HERMITAGE</b>	<b>HEC003</b>	6,5	120	120	<b>430</b>

coppia gambe ceramica

*pair of ceramic legs*



codice	colore	kg	pz. pallet Italia	pz. pallet Export	euro
<b>HERMITAGE</b>	<b>HEA015</b>	10	-	-	<b>1500</b>
	<b>HEA015</b>	10	-	-	<b>1900</b>
	<b>HEA015</b>	10	-	-	<b>1900</b>

struttura per lavabo 68, cromo, bronzo, oro

*structure for washbasin 68 chrome, bronze, gold*



schede tecniche  
technical drawing



codice	colore	kg	pz. pallet Italia	pz. pallet Export	euro
<b>HERMITAGE</b>	<b>HEA016</b>	12	-	-	<b>1900</b>
	<b>HEA016</b>	12	-	-	<b>2400</b>
	<b>HEA016</b>	12	-	-	<b>2400</b>

struttura per lavabo 92 cromo, bronzo, oro

*structure for washbasin 92 chrome, bronze, gold*



schede tecniche  
technical drawing



codice	colore	kg	pz. pallet Italia	pz. pallet Export	euro
<b>HERMITAGE</b>	<b>HEA017</b>	13	-	-	<b>1800</b>
	<b>HEA017</b>	13	-	-	<b>2300</b>
	<b>HEA017</b>	13	-	-	<b>2300</b>

struttura per lavabo 112 cromo, bronzo, oro

*structure for washbasin 112 chrome, bronze, gold*



schede tecniche  
technical drawing

# HERMITAGE OVERVIEW



codice	colore	kg	pz. pallet Italia	pz. pallet Export	euro
<b>HERMITAGE   170 x 80 h 72</b>	<b>HEW001</b>	40	-	-	<b>3050</b>
	<b>HEW001</b>	40	-	-	<b>3400</b>
	<b>HEW001</b>	40	-	-	<b>3400</b>
	<b>HEW001</b>	40	-	-	<b>3400</b>

vasca bianca con accessori metallici cromo, bronzo, oro

*white bathtub with metal accessories chrome, bronze, gold*



schede tecniche  
technical drawing

# HERMITAGE ACCESSORIES

codice	colore	kg	pz. pallet Italia	pz. pallet Export	euro
<b>ACA032</b>		0,3	-	-	<b>75</b>
<b>ACA036</b>	<b>01</b>	0,3	-	-	<b>80</b>
<b>ACA022</b>		1	-	-	<b>130</b>
<b>ACA021</b>		1	-	-	<b>100</b>
<b>ACA016</b>		4	-	-	<b>70</b>
<b>ACA104</b>		0,3	-	-	<b>15</b>

piletta universale up & down cromo

*chrome up & down drain*



piletta universale up & down con tappo in ceramica, con Saniglaze

*up & down universal drain with ceramic cover for washbasins, with Saniglaze*

sifone cilindrico cromo  
*chrome siphon*

sifone ridotto - *reduced siphon*

staffe di fissaggio per sospesi  
*fitting system kit for wall-hung*

protezione adesiva antirumore zig/zag  
*soundproof zig/zag*

# TEN



Scopri online  
Discover it online

Collezione di sanitari a terra,  
filomuro e sospesi scarico  
The.Rimless; con lavabo  
coordinato

Wall-hung and back to wall  
The.Rimless sanitaryware  
collection; with coordinated  
washbasin



# SANITARYWARE COLLECTION

Measure, proportion, form.

The Ten collection expresses an essential, well-balanced design, conceived to integrate naturally into contemporary bathroom spaces. Clean, harmonious forms define a sober language that engages with architecture without overpowering it, leaving room for the overall project.

A versatile and cross-cutting series, Ten adapts to different contexts thanks to a discreet, contemporary and timeless aesthetic. The collection includes wall-hung, back-to-wall and floor-mounted sanitaryware detached from the wall, offering a complete range of design solutions.

# Misura, proporzione, forma.

La collezione Ten esprime un design essenziale e misurato, pensata per integrarsi con naturalezza nei bagni contemporanei. Le forme pulite ed equilibrate definiscono un linguaggio sobrio che dialoga con l'architettura senza imporsi, lasciando spazio al progetto nel suo insieme. È una serie versatile e trasversale, che si adatta a contesti diversi grazie a un'estetica discreta, attuale e senza tempo. La collezione comprende sanitari sospesi, filomuro e a terra staccati dalla parete, offrendo una gamma completa di soluzioni progettuali.

**TEV006 + TEA005 | 36 x 52**

Vaso sospeso Senza Brida  
*Wall-hung Rimless WC*

**TEB004 | 36 x 52**

Bidet sospeso  
*Wall-hung bidet*



**TEV006 + TEA005 | 36 x 52**

Vaso sospeso Senza Brida  
Wall-hung Rimless WC

**TEB004 | 36 x 52**

Bidet sospeso  
Wall-hung bidet



The volumes are characterised by a sinuous form that tapers towards a modern floor-standing base, a detail that visually lightens the composition and reinforces its contemporary identity. In the wall-hung version, the sanitaryware appears more compact and sharply defined, emphasising its formal clarity. Completing the series, the coordinated washbasin echoes the same formal language and can be installed in multiple configurations - wall-hung, on a column or semi-column - ensuring aesthetic consistency and design flexibility.

I volumi si caratterizzano per una forma sinuosa che rastrema verso un “piede a terra” dal disegno moderno, un dettaglio che alleggerisce visivamente l’insieme e ne rafforza l’identità contemporanea. Nella versione sospesa, il corpo del sanitario appare invece più netto e compatto, enfatizzandone la pulizia formale. A completamento della serie, il lavabo coordinato riprende lo stesso linguaggio formale dei sanitari ed è installabile in diverse configurazioni - sospeso, su colonna o semicolonna - garantendo coerenza estetica e flessibilità progettuale.



**TEV008 + TEA005 | 36 x 52**

Vaso terra filomuro Senza Brida traslato  
*Back to wall Rimless WC*

**TEB005 | 36 x 52**

Bidet terra filomuro  
*Back to wall bidet*





**TEV001 + TEA002 | 36 x 52**

Vaso terra scarico "S"  
"S" trap floor WC

**TEB003 | 36 x 52**

Bidet terra  
Floor bidet



**TELO01 + TEC004 | 65 x 51**

Lavabo con semicolonna  
*Washbasin with semi column*



# TEN COLLECTION DNA

Scopri le caratteristiche tecniche principali della collezione Ten  
*Discover the main technical features of the Ten collection*

## THE RIMLESS

Sistema di scarico senza brida: niente zone nascoste, pulizia più facile e getto uniforme per migliore igiene ed efficienza.

*Rimless flush system: no hidden areas, easier cleaning, and an even water flow for better hygiene and efficiency.*



## SCARICO TRASLATO

Il vaso filomuro dispone di scarico traslato. Le connessioni di scarico sono regolabili grazie agli abbinamenti delle curve con i manicotti (concentrico od eccentrici) – da acquistare separatamente.

*The back to wall WC has an adjustable flush. Drainage connections can be adjust thanks to the combinations of the curves with the pipes (concentric or eccentric) – to be purchased separately.*

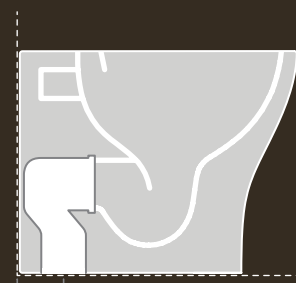

**ACA005 + ACA076** > 10 CM  
**ACA005 + ACA077** > 8/12 CM  
**ACA005 + ACA078** > 14 CM  
CURVA TECNICA S + MANICOTTO DI SCARICO A PAVIMENTO  
ELBOW AT FLOOR S + ARRANGEMENT DISCHARGE TO FLOOR

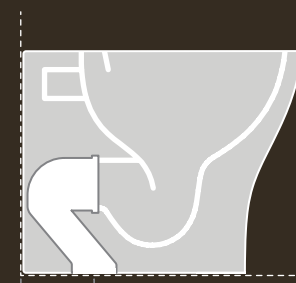

**ACA074 + ACA076** > 15 CM  
**ACA074 + ACA077** > 13/17 CM  
CURVA TECNICA TRASLATA + MANICOTTO DI SCARICO A PAVIMENTO  
ADJUSTABLE PIPE + ARRANGEMENT DISCHARGE TO FLOOR

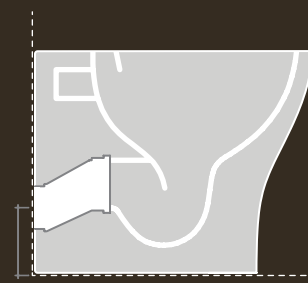

**ACA075**  
RACCORDO DI SCARICO A PARETE TRASLATO H 18 CM  
WALL TRAP ADJUSTABLE PIPE H 18 CM

# TEN STYLES

## CLASSIC COLORS



cod. 01

bianco lucido / glossy white



cod. 05

bianco matt / matt white

# TEN OVERVIEW



THE RIMLESS

## TEN 4.0 | 36 x 52

vaso sospeso Senza Brida

wall-hung Rimless Wc



schede tecniche  
technical drawing

codice	colore	kg	pz. pallet Italia	pz. pallet Export	euro
CLASSIC COLORS					
TEV006	○ 01; 00	20	12	20	270
TEV006	◎ 05; 00	20	12	20	390

* kit fissaggio per sanitari sospesi obbligatorio, non incluso con il sanitario	ACA052	0,3	-	-	25
---	--------	-----	---	---	----

mandatory fitting system kit for wall-hung sanitaryware, not included with the sanitaryware



## TEN 4.0 | 36 x 52

bidet sospeso 1 foro

wall-hung bidet 1 hole



schede tecniche  
technical drawing

codice	colore	kg	pz. pallet Italia	pz. pallet Export	euro
CLASSIC COLORS					
TEB004	○ 01; 00	20	12	20	270
TEB004	◎ 05; 00	20	12	20	390

* kit fissaggio per sanitari sospesi obbligatorio, non incluso con il sanitario	ACA052	0,3	-	-	25
---	--------	-----	---	---	----

mandatory fitting system kit for wall-hung sanitaryware, not included with the sanitaryware

\*

Il tappo del troppopieno è coordinato al colore della ceramica, ad eccezione della versione in ceramica bianca lucida, abbinata a tappo cromo.

\*

The overflow cover is matched to the ceramic color, except for the glossy white ceramic version, which is paired with a chrome cover.

# TEN OVERVIEW



THE RIMLESS

SCARICO TRASLATO

## TEN 4.0 | 36 x 52

vaso terra filomuro Senza Brida traslato

back to wall Rimless Wc adjustable flush



schede tecniche  
technical drawing

codice	colore	kg	pz. pallet Italia	pz. pallet Export	euro
CLASSIC COLORS					
TEV008	○ 01; 00	27	10	20	270
TEV008	◎ 05; 00	27	10	20	390

* kit fissaggio laterale per sanitari obbligatorio, non incluso con il sanitario	ACA020	0,3	-	-	15
--	--------	-----	---	---	----

mandatory fitting system kit for sanitaryware, not included with the sanitaryware



## TEN 4.0 | 36 x 52

bidet terra filomuro 1 foro

back to wall bidet 1 hole



schede tecniche  
technical drawing

codice	colore	kg	pz. pallet Italia	pz. pallet Export	euro
CLASSIC COLORS					
TEB005	○ 01; 00	26	10	20	270
TEB005	◎ 05; 00	26	10	20	390

* kit fissaggio laterale per sanitari obbligatorio, non incluso con il sanitario	ACA020	0,3	-	-	15
--	--------	-----	---	---	----

mandatory fitting system kit for sanitaryware, not included with the sanitaryware

# TEN OVERVIEW



## TEN | 36 x 52

codice	colore	kg	pz. pallet Italia	pz. pallet Export	euro
TEV001	○ 01; 00	26	10	20	290

vaso terra scarico "S"

"S" trap floor WC



schede tecniche  
technical drawing

* kit fissaggio laterale per sanitari obbligatorio, non incluso con il sanitario	ACA020	0,3	-	-	15
--	--------	-----	---	---	----

mandatory fitting system kit for sanitaryware, not included with the sanitaryware



## TEN | 36 x 52

codice	colore	kg	pz. pallet Italia	pz. pallet Export	euro
TEB003	○ 01; 00	24	10	20	290

bidet terra 1 foro

floor bidet 1 hole



schede tecniche  
technical drawing

* kit fissaggio laterale per sanitari obbligatorio, non incluso con il sanitario	ACA020	0,3	-	-	15
--	--------	-----	---	---	----

mandatory fitting system kit for sanitaryware, not included with the sanitaryware

# TEN OVERVIEW



## TEN | 45 x 23

codice	colore	kg	pz. pallet Italia	pz. pallet Export	euro
TEC001	○ 01; 00	5	-	-	75

cassetta alta universale

universal high ceramic cistern



## TEN

TEA002	○ 01; 20	3	-	-	95
--------	----------	---	---	---	----

seduta per Wc non frizionata

standard Wc seat



## TEN

CLASSIC COLORS

TEA005	○ 01; 00	3	-	-	180
--------	----------	---	---	---	-----

seduta Slim per Wc frizionata

soft-close Slim Wc seat

TEA011	⊙ 05; 00	3	-	-	260
--------	----------	---	---	---	-----



## TEN

TEA012	○ 01; 20	3,5	-	-	295
--------	----------	-----	---	---	-----

seduta per WC frizionata a sgancio rapido Magiclight

easy take off soft-close Magiclight WC seat

# TEN STYLES



## TEN | 65 x 51

lavabo 1 foro sospeso/da colonna

*wall-hung/for column 1 hole  
washbasin*



*schede tecniche  
technical drawing*

codice	colore	kg	pz. pallet Italia	pz. pallet Export	euro
TELO01	○ 01; 00	3	18	24	195

\* tasselli per fissaggio lavabi sospesi, non inclusi con il lavabo

*fitting system kit for wall-hung washbasins, not included with the washbasin*

ACA007		0,3	-	-	15
--------	--	-----	---	---	----



## TEN | 36 x 67

colonna - column

TEC003	○ 01; 00	14	8	12	175
--------	----------	----	---	----	-----



## TEN | 32 x 50

semicolonna - semi column

TEC004	○ 01; 00	7	-	-	145
--------	----------	---	---	---	-----

# TEN ACCESSORIES

	codice	colore	kg	pz. pallet Italia	pz. pallet Export	euro
sifone ridotto - <i>reduced siphon</i>	ACA021		1	-	-	100
staffe di fissaggio per sospesi <i>fitting system kit for wall-hung</i>	ACA016		4	-	-	70
riduttore di flusso di scarico per WC <i>plug for reducing water flow</i>	ACA064		4	-	-	15
curva tecnica S <i>elbow at floor S</i>	ACA005		0,3	-	-	25
manicotto concentrico <i>concentric pipe</i>	ACA076		0,3	-	-	20
manicotto eccentrico 2 cm <i>eccentric pipe 2 cm</i>	ACA077		0,3	-	-	20
manicotto eccentrico 4 cm <i>eccentric pipe 4 cm</i>	ACA078		0,3	-	-	25
raccordo scarico parete "P" traslato <i>"P" trap adjustable pipe</i>	ACA075		0,3	-	-	25
curva tecnica traslata <i>adjustable pipe</i>	ACA074		0,3	-	-	40
protezione adesiva antirumore zig/zag <i>soundproof zig/zag</i>	ACA104		0,3	-	-	15
sifone cilindrico cromo <i>chrome siphon</i>	ACA022		1	-	-	130

# URINALS

ORINATOI  
THE.ARTCERAM

BABILA (P.398)  
LA FONTANA 2.0 (P.404)

# BA BILA



Scopri online  
Discover it online



## URINAL COLLECTION

Evocative Minimalism.

Orinatoio / dal latino Urinalis / noun [der. of to urinate] - [a fixture used for urinating used only by men] ≈ (pop.) pisser. Down-to-earth things can be revisited in a much more noble appearance! We have perfectly balanced straight lines, arches and semi-arches defining space and architecture. A minimalist but evocative look that reminds of that transition period between fine art déco and Milanese monumental architecture, symbol of the typical architectural soul of the '20s.

# Minimalismo evocativo.

Orinatoio / dal latino Urinalis / s. m. [der. di orinare] - [apparecchiatura igienica per orinare destinata ai soli uomini] ≈ (pop.) pisciatoio, vespasiano. Perché anche le cose più umili possono essere rivisitate con una nuova veste più nobile! Abbiamo trovato il giusto equilibrio tra le linee rette, archie semi-archi che definiscono lo spazio e l'architettura. Per un'estetica minimale ma evocativa che rimanda a quel periodo di transizione tra fine art déco e architettura monumentale meneghina, simbolo della tipica anima architettonica anni '20.

**BR0001 | 37 x 30 h 64**

Orinatio

Urinal



**BR0001 | 37 x 30 h 64**  
 Orinatorio  
 Urinal



# BABILA STYLES

## CLASSIC COLORS



cod. 01  
 bianco lucido / glossy white



cod. 05  
 bianco matt / matt white



cod. 17  
 nero matt / matt black

## BABILA OVERVIEW



### BABILA | 37 x 30 h 64

orinatoio con sifone, con Saniglaze

urinal with siphon, with Saniglaze



schede tecniche  
 technical drawing

codice	colore	kg	pz. pallet Italia	pz. pallet Export	euro
CLASSIC COLORS					
<b>BR0001</b>	○ 01; 00	14	9	24	<b>390</b>
<b>BR0001</b>	◎ 05; 00	14	9	24	<b>550</b>
<b>BR0001</b>	● 17; 00	14	9	24	<b>550</b>

\* kit fissaggio laterale per sanitari obbligatorio, non incluso con il sanitario

**ACA020**

0,3 - - 15

mandatory fitting system kit for sanitaryware, not included with the sanitaryware

# LA FON TANA 2.0



Scopri online  
Discover it online



## URINAL COLLECTION

The Evolution of an Icon.  
Artceram will re-launch on the market the most iconic collection La Fontana, that represented a turning point in The.Artceram pathway. The urinal have now a new look, a 2.0 version characterized by a “Millennial oriented” touch addressed to young people with a new bathroom perspective. The idea behind the new La Fontana is innovation, respecting the original 2006 design, but with a look at the past and the main features of the original project.

# L'evoluzione di un'icona.

Artceram ripropone l'iconica collezione La Fontana, che rappresentò un vero e proprio punto di svolta nel percorso dell'azienda. L'orinatoio viene rivisitato in una nuova versione 2.0, che si potrebbe definire “Millennial oriented”, rivolta ad una clientela giovane e caratterizzata da un nuovo modo di leggere e vivere il bagno. La filosofia alla base della nuova La Fontana è la volontà di innovare e tenersi al passo con i tempi, con un occhio al passato e senza mai perdere di vista i capisaldi del progetto originale.

LF0002 | 33 x 31 h 62  
Orinatio  
Urinal



# LA FONTANA 2.0 STYLES

LF0002 | 33 x 31 h 62  
Orinatorio  
Urinal



## CLASSIC COLORS



bianco lucido / glossy white



bianco matt / matt white



nero matt / matt black

## LA FONTANA 2.0 OVERVIEW



THE  
SANIGLAZE

### LA FONTANA 2.0 33 x 31 h 62

orinatoio con sifone, con Saniglaze

urinal with siphon, with Saniglaze



schede tecniche  
technical drawing

codice	colore	kg	pz. pallet Italia	pz. pallet Export	euro
CLASSIC COLORS					
LF0002	01; 34	15	-	-	360
LF0002	05; 34	15	-	-	510
LF0002	17; 34	15	-	-	510

\* kit fissaggio laterale per sanitari obbligatorio, non incluso con il sanitario

ACA020

0,3 - - 15

mandatory fitting system kit for sanitaryware, not included with the sanitaryware

# WASH BASINS

LAVABI  
THE.ARTCERAM

JOLIE (P.412)  
BROOKLYN (P.424)  
WON (P.442)  
WHISKY (P.458)  
COGNAC  
& COGNAC QUADRO (P.468)  
RODOLFO (P.494)  
SCALINO (P.508)  
BRERA (P.522)  
FUORI SCALA (P.538)  
ROMBO & MILLERIGHE (P.550)  
ATELIER (P.564)  
GHOST (P.574)  
LA CIOTOLA (P.584)  
LAVAMANI (P.594)  
SOTTOPIANO (P.606)

# JOLIE



Scopri online  
Discover it online



WASHBASINS

Lavabo a colonna freestanding  
o da appoggio

Freestanding for column /  
countertop washbasin

# COLUMN WASHBASIN SYSTEM



archiproducts  
DESIGN AWARDS

WINNER 2021

A precious balance.  
Freestanding basin in ceramic with a “new vintage style”,  
solid and chameleonic, characterized by two precise,  
unbalanced and antithetic entities, divided but united  
through a binding element that looks like a jewel,  
a “divide et impera” ring exalting finishes and colours.

# Un equilibrio prezioso.

Centrostanza ceramico in stile “new vintage”, materico e camaleontico, caratterizzato da due entità ben precise, antitetiche e sbilanciate, tanto divise quanto unite attraverso un legante che possiamo definire un gioiello, un anello che “divide et impera” esaltando finiture e colori.

**JOL001 + JOC001 | Ø 50**  
Lavabo da colonna  
*For column washbasin*

**ACA073**  
Anello per colonna  
*For column washbasin  
oro / gold*





**JOL001 + JOC001 | Ø 50**  
Lavabo da colonna  
For column washbasin

**ACA073**  
Anello per colonna  
For column washbasin  
oro / gold

This is a contemporary project based on the instable balance of its parts, on the stability of the pedestal that supports an instable stoup. The instability and poetic idea of contrasting elements it's interrupted by a third solid element that unites the instable poles and creates a perfect stability.

Si tratta di un progetto contemporaneo, che si basa sull'equilibrio instabile delle parti, sulla stabilità della colonna che sorregge una precaria acquasantiera. Tuttavia la precarietà e la poetica degli opposti viene interrotta da un terzo elemento materico a contrasto che unisce i poli generando stabilità tra le parti.

A destra / On the right:

**JOL001 | Ø 50**

Lavabo da appoggio  
Countertop washbasin

## JOLIE SYSTEM

Il lavabo Jolie può tranquillamente "esistere" anche senza la sua colonna, semplicemente installandolo in appoggio su un piano! La vasca dalle dimensioni importanti, con un occhio di riguardo alla forma perfetta del cerchio, mette in risalto l'obiettività della forma armonica che va a braccetto con la contemporaneità.

*The basin Jolie can be installed even without its pedestal simply mounting it on a top!  
A very big bowl with a perfect round design exalting its balanced shape and matching it with contemporary ideas.*



**JOL001 + JOC001 | Ø 50**

Lavabo da colonna  
For column washbasin  
curcuma / turmeric

**ACA073**

Anello per colonna  
For column washbasin  
oro / gold



# JOLIE STYLES

## CLASSIC COLORS



cod. 01  
bianco lucido / glossy white



cod. 05  
bianco matt / matt white



cod. 17  
nero matt / matt black

## MATT COLORS



cod. 15  
grigio oliva / grey olive



cod. 38  
blu avio / blue avio



cod. 41  
marrone matera / brown matera



cod. 59  
sabbia / sand



cod. 60  
ghiaia / gravel

## GLOSSY COLORS



cod. 67  
curcuma / turmeric



cod. 68  
paprika / paprika



cod. 69  
edera / ivy



cod. 70  
zefiro / zephyr

## METALS



cod. 17  
nero matt / matt black  
RAL 9005

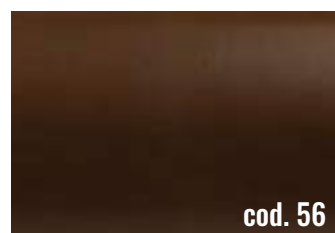

cod. 56  
moka / moka  
RAL 8014



cod. 53  
oro / gold

\*Disponibili solo per l'anello  
Available for the ring only

# JOLIE OVERVIEW



## JOLIE | Ø 50

lavabo appoggio/da colonna

countertop/for column  
washbasin



schede tecniche  
technical drawing



anello per colonna + piletta filettata  
cromo inclusa

ring for column with threaded  
chrome drain included  
in the price



colonna per lavabo Ø 50

column for washbasin Ø 50

\* É obbligatorio acquistare ed  
installare l'anello sulla colonna  
per montare il lavabo!

You must purchase and install  
the ring on the column for  
mounting the washbasin!

codice	colore	kg	pz. pallet Italia	pz. pallet Export	euro
--------	--------	----	-------------------	-------------------	------

### CLASSIC COLORS

JOL001	○ 01; 00	10	20	40	370
JOL001	◎ 05; 00	10	20	40	560
JOL001	● 17; 00	10	20	40	560

### MATT COLORS

JOL001	00	10	20	40	560
--------	----	----	----	----	-----

### GLOSSY COLORS

JOL001	00	10	20	40	560
--------	----	----	----	----	-----

### METALS

ACA073	● 53	0,2	-	-	190
ACA073	● 17	0,2	-	-	160
ACA073	● 56	0,2	-	-	160

### CLASSIC COLORS

JOC001	○ 01; 00	12	-	-	295
JOC001	◎ 05; 00	12	-	-	450
JOC001	● 17; 00	12	-	-	450

### MATT COLORS

JOC001	34	13	-	-	450
--------	----	----	---	---	-----

### GLOSSY COLORS

JOC001	34	13	-	-	450
--------	----	----	---	---	-----

# JOLIE ACCESSORIES

	codice	colore	kg	pz. pallet Italia	pz. pallet Export	euro
piletta universale up & down cromo	<b>ACA032</b>		0,3	-	-	<b>75</b>

*chrome up & down drain*



piletta universale up & down con tappo in ceramica, con Saniglaze

*up & down universal drain with ceramic cover for washbasins, with Saniglaze*

## CLASSIC COLORS

<b>ACA036</b>	○	01; 34	0,3	-	-	<b>80</b>
<b>ACA038</b>	◎	05; 34	0,3	-	-	<b>90</b>
<b>ACA038</b>	●	17; 34	0,3	-	-	<b>90</b>

## MATT COLORS

<b>ACA038</b>		34	0,3	-	-	<b>90</b>
---------------	--	----	-----	---	---	-----------

## GLOSSY COLORS

<b>ACA038</b>		34	0,3	-	-	<b>90</b>
---------------	--	----	-----	---	---	-----------

piletta cromo con troppo pieno integrato	<b>ACA096</b>		0,3	-	-	<b>85</b>
--	---------------	--	-----	---	---	-----------

*chrome drain with integral overflow*



piletta con tappo in ceramica e troppo pieno integrato, con Saniglaze

*drain with ceramic cover and integral overflow, with Saniglaze*

## CLASSIC COLORS

<b>ACA097</b>	○	01; 34	0,3	-	-	<b>90</b>
<b>ACA097</b>	◎	05; 34	0,3	-	-	<b>90</b>
<b>ACA097</b>	●	17; 34	0,3	-	-	<b>90</b>

## MATT COLORS

<b>ACA097</b>		34	0,3	-	-	<b>90</b>
---------------	--	----	-----	---	---	-----------

## GLOSSY COLORS

<b>ACA097</b>		34	0,3	-	-	<b>90</b>
---------------	--	----	-----	---	---	-----------

# JOLIE ACCESSORIES

	codice	colore	kg	pz. pallet Italia	pz. pallet Export	euro	
tappo in ceramica per piletta filettata	<b>ACA069</b>	○	01; 00	0,3	-	-	<b>29</b>

*ceramic cover for threaded drain*

## CLASSIC COLORS

<b>ACA069</b>	◎	05; 00	0,3	-	-	<b>29</b>
<b>ACA069</b>	●	17; 00	0,3	-	-	<b>29</b>

## MATT COLORS

<b>ACA069</b>			0,3	-	-	<b>29</b>
---------------	--	--	-----	---	---	-----------

## GLOSSY COLORS

<b>ACA069</b>			0,3	-	-	<b>29</b>
---------------	--	--	-----	---	---	-----------

sifone cilindrico cromo	<b>ACA022</b>		1	-	-	<b>130</b>
-------------------------	---------------	--	---	---	---	------------

*chrome siphon*

sifone cilindrico - siphon	<b>ACA099</b>	◎	05	1	-	-	<b>180</b>
	<b>ACA099</b>	●	17	1	-	-	<b>180</b>

# BROOKLYN



Scopri la online  
Discover it online



WASHBASINS

## WASHBASINS & STRUCTURES COLLECTION



Selezione Compasso d'Oro

archiproducts  
AWARDS  
WINNER



Collezione di lavabi sospesi,  
da appoggio e per strutture  
dedicate

Collection of countertop,  
wall-hung and for structure  
washbasins

Thin-edge elegance.

Brooklyn is an unconventional collection with thin edges, positioned halfway between a countertop sink and a console, merging features of both. It consists of four sinks with modern, soft lines, designed for those who seek an elegant, contemporary, and highly functional product.

# Eleganza a bordo fino.

Brooklyn è una collezione a bordo fino non convenzionale, a metà strada tra un lavabo d'appoggio e una consolle, capace di unire le caratteristiche di entrambi. La collezione comprende quattro lavabi dalle linee moderne e morbide, pensati per chi cerca un prodotto elegante, contemporaneo ed estremamente funzionale.



**BNL002 | 90 x 40**

Lavabo appoggio/sospeso/  
per struttura dedicata  
Countertop/wall-hung/  
for structure washbasin



**BNL002 + ACA092 | 90 x 40**

Lavabo sospeso  
con portasciugamani  
Wall-hung washbasin  
with towel rail



Each sink incorporates a ceramic "band" with a dual purpose: a countertop and a potential faucet support. This element divides and connects the perimeter of the sink into two distinct areas: a wet zone, the basin itself, and a dry "pocket" that offers storage or support for accessories. The flat part, either at the back or on the side depending on the model, becomes the junction between aesthetics and functionality, achieving a perfect balance.

WASHBASINS

Ogni lavabo integra una fascia in ceramica con duplice funzione: piano d'appoggio e supporto per il rubinetto. Questo elemento divide e collega il perimetro del lavabo in due aree distinte: una zona umida, il bacino stesso, e una zona secca, una "tasca" che può accogliere accessori o fungere da contenimento. La parte piana, posteriore o laterale a seconda delle dimensioni, diventa così punto di congiunzione tra estetica e praticità, in un equilibrio perfetto.

**BNL004 | 60 x 35**

Lavabo appoggio/sospeso  
Countertop/wall-hung  
washbasin



**BNL003 + ACA093 | 65 x 40**

Lavabo sospeso  
con portasciugamani  
Wall-hung washbasin  
with towel rail



A sinistra / On the left:

**BNL002 + ACM044 | 90 x 40**

Lavabo con struttura dedicata  
in massello noce canaletto  
con cassettone integrato  
laccato color moka matt

*Washbasin with structure  
in solid Canaletto walnut  
with integrated drawer  
lacquered in matt moka color*

**BNL001 | 100 x 50**

Lavabo sospeso/appoggio  
Wall-hung/countertop  
washbasin



# BROOKLYN FAUCET PLACEMENT

## BNL003 + ACM043 | 65 x 40

Lavabo con struttura dedicata  
in massello noce canaletto  
con cassettone integrato  
laccato color moka matt

*Washbasin with structure  
in solid Canaletto walnut  
with integrated drawer  
lacquered in matt moka color*



Offriamo la massima personalizzazione del prodotto! Con i lavabi Brooklyn, il cliente finale può scegliere se installare una rubinetteria classica monoforo, due fori o tre, o anche a muro; sia a DX che SX, in base alle proprie preferenze! Tutti i lavabi presentano fori 'preforati': la fascia di ceramica è piena e smaltata sulla parte superiore, mentre sul retro non smaltato sono segnati i fori, che potranno essere aperti da un installatore professionista per garantire fori precisi.

*We offer the highest level of product customization! With the Brooklyn sinks, the end customer can choose to install a classic single-hole, two-hole, or three-hole faucet, or even wall-mounted, either on the right or left, according to their preferences! All sinks feature 'preforated' holes: the ceramic rim is solid and glazed on the top, while on the unglazed back, the holes are marked, and can be opened by a professional installer to ensure precise holes.*

### BROOKLYN 100 (BNL001)

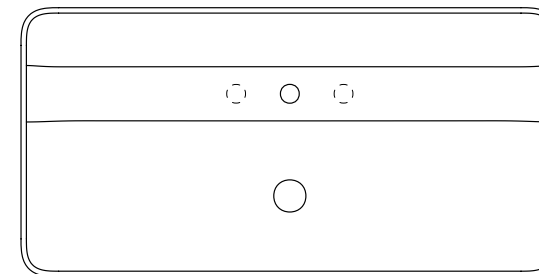

### BROOKLYN 90 (BNL002)

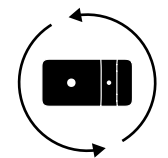
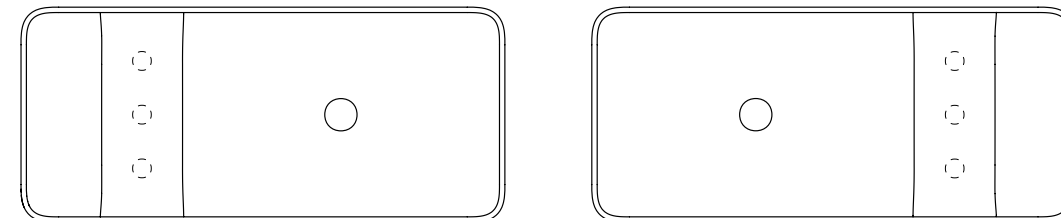

### BROOKLYN 65 (BNL003)

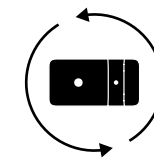
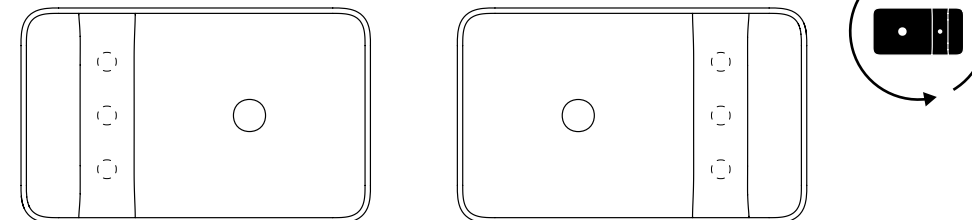

### BROOKLYN 60 (BNL004)

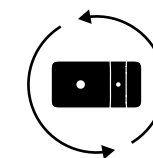
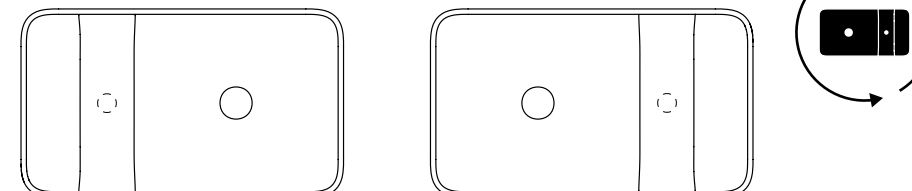

# BROOKLYN STYLES

## CLASSIC COLORS



cod. 01

bianco lucido / glossy white



cod. 05

bianco matt / matt white



cod. 17

nero matt / matt black

## MATT COLORS



cod. 15

grigio oliva / grey olive



cod. 38

blu avio / blue avio



cod. 41

marrone matera / brown matera



cod. 59

sabbia / sand



cod. 60

ghiaia / gravel

## GLOSSY COLORS



cod. 67

curcuma / turmeric



cod. 68

paprika / paprika



cod. 69

edera / ivy



cod. 70

zefiro / zephyr

## METALS



nero matt / matt black  
RAL 9005

## STORAGE



moka / moka  
RAL 8014



noce canaletto / canaletto walnut

\*Unico colore disponibile per le barre porta asciugamani  
Only colour available for towel rails

\*Unica combinazione colore disponibile per le strutture  
Only colour combination available for the structures

# BROOKLYN OVERVIEW



THE  
SANIGLAZE

## BROOKLYN 100 | 100 x 50

lavabo sospeso/appoggio  
1 foro (predisposto 3 fori),  
con Saniglaze

wall-hung/countertop  
washbasin 1 hole with arrangements  
for 3 holes, with Saniglaze



schede tecniche  
technical drawing

codice	colore	kg	pz. pallet Italia	pz. pallet Export	euro
--------	--------	----	-------------------	-------------------	------

### CLASSIC COLORS

<b>BNL001</b>	○ 01;	34	35	10	20	600
<b>BNL001</b>	◎ 05;	34	35	10	20	960
<b>BNL001</b>	● 17;	34	35	10	20	960

### MATT COLORS

<b>BNL001</b>		34	35	10	20	960
---------------	--	----	----	----	----	-----

### GLOSSY COLORS

<b>BNL001</b>		34	35	10	20	960
---------------	--	----	----	----	----	-----

\* coppia staffe per Brooklyn 100  
obbligatorie per fissaggio lavabo  
sospeso

<b>ACA087</b>		-	-	-	-	110
---------------	--	---	---	---	---	-----

fitting system kit for Brooklyn 100  
compulsory for fixing wall-hung  
washbasin

portasciugamani  
per lavabo Brooklyn 100

<b>ACA091</b>	◎	5	-	-	-	395
---------------	---	---	---	---	---	-----

towel rail for washbasin  
Brooklyn 100

WASHBASINS

# BROOKLYN OVERVIEW



THE SANIGLAZE

## BROOKLYN 90 | 90 x 40

lavabo rettangolare appoggio/  
sospeso/per struttura dedicata  
senza foro (predisposto 3 fori),  
con Saniglaze

rectangular countertop/wall-hung/  
for structure washbasin no hole  
with arrangements  
for 3 holes, with Saniglaze



schede tecniche  
technical drawing

codice	colore	kg	pz. pallet Italia	pz. pallet Export	euro
CLASSIC COLORS					
BNL002	○ 01;	34	25	12	24 580
BNL002	◎ 05;	34	25	12	24 930
BNL002	● 17;	34	25	12	24 930
MATT COLORS					
BNL002		34	25	12	24 930
GLOSSY COLORS					
BNL002		34	25	12	24 930

\* coppia staffe per Brooklyn 90/65  
obbligatorie per fissaggio lavabo  
sospeso

ACA089 - - - 110

fitting system kit for Brooklyn  
90/65 compulsory for fixing  
wall-hung washbasin



struttura per lavabo Brooklyn 90  
in massello noce canaletto  
con cassettone integrato  
laccato color moka matt

structure for washbasin Brooklyn  
90 in solid Canaletto walnut  
with integrated drawer  
lacquered in matt moka color



schede tecniche  
technical drawing

ACM044 25 - - 3400

portasciugamani  
per lavabo Brooklyn 90

ACA092 ● 3.7 - - 360

towel rail for washbasin  
Brooklyn 90



# BROOKLYN OVERVIEW



THE SANIGLAZE

## BROOKLYN 65 | 65 x 40

lavabo rettangolare appoggio/  
sospeso/per struttura dedicata  
senza foro (predisposto 3 fori),  
con Saniglaze

rectangular countertop/wall-hung/  
for structure washbasin no hole  
with arrangements  
for 3 holes, with Saniglaze



schede tecniche  
technical drawing

codice	colore	kg	pz. pallet Italia	pz. pallet Export	euro
CLASSIC COLORS					
BNL003	○ 01;	34	19	20	33 550
BNL003	◎ 05;	34	19	20	33 880
BNL003	● 17;	34	19	20	33 880
MATT COLORS					
BNL003		34	19	20	33 880
GLOSSY COLORS					
BNL003		34	19	20	33 880

\* coppia staffe per Brooklyn 90/65  
obbligatorie per fissaggio lavabo  
sospeso

ACA089 - - - 110

fitting system kit for Brooklyn  
90/65 compulsory for fixing  
wall-hung washbasin



struttura per lavabo Brooklyn 65  
in massello noce canaletto  
con cassettone integrato  
laccato color moka matt

structure for washbasin Brooklyn  
65 in solid Canaletto walnut  
with integrated drawer  
lacquered in matt moka color



schede tecniche  
technical drawing

ACM043 20 - - 3200

portasciugamani  
per lavabo Brooklyn 65

ACA093 ● 3 - - 275

towel rail for washbasin  
Brooklyn 65



# BROOKLYN OVERVIEW



THE SANIGLAZE

## BROOKLYN 60 | 60 x 35 h25

lavabo rettangolare appoggio/sospeso senza foro (predisposto 1 foro), con Saniglaze

rectangular countertop/wall-hung washbasin no hole with arrangements for 1 hole, with Saniglaze



schede tecniche  
technical drawing

codice	colore	kg	pz. pallet Italia	pz. pallet Export	euro	
CLASSIC COLORS						
<b>BNL004</b>	○ 01; 34	22	16	32	<b>500</b>	
<b>BNL004</b>	◎ 05; 34	22	16	32	<b>800</b>	
<b>BNL004</b>	● 17; 34	22	16	32	<b>800</b>	
MATT COLORS						
<b>BNL004</b>		34	22	16	32	<b>800</b>
GLOSSY COLORS						
<b>BNL004</b>		34	22	16	32	<b>800</b>

\* coppia staffe per Brooklyn 60 obbligatorie per fissaggio lavabo sospeso

**ACA090** - - - **110**

fitting system kit for Brooklyn 60 compulsory for fixing wall-hung washbasin

# BROOKLYN ACCESSORIES

piletta universale up & down cromo

**ACA032** 0,3 - - **75**

chrome up & down drain

piletta universale up & down con tappo in ceramica, con Saniglaze

CLASSIC COLORS

**ACA036** ○ 01; 34 0,3 - - **80**

**ACA038** ◎ 05; 34 0,3 - - **90**

**ACA038** ● 17; 34 0,3 - - **90**

up & down universal drain with ceramic cover for washbasins, with Saniglaze

MATT COLORS

**ACA038** 34 0,3 - - **90**

GLOSSY COLORS

**ACA038** 34 0,3 - - **90**

piletta cromo con troppo pieno integrato  
chrome drain with integral overflow

**ACA096** 0,3 - - **85**

piletta con tappo in ceramica e troppo pieno integrato, con Saniglaze

CLASSIC COLORS

**ACA097** ○ 01; 34 0,3 - - **90**

**ACA097** ◎ 05; 34 0,3 - - **90**

**ACA097** ● 17; 34 0,3 - - **90**

drain with ceramic cover and integral overflow, with Saniglaze

MATT COLORS

**ACA097** 34 0,3 - - **90**

GLOSSY COLORS

**ACA097** 34 0,3 - - **90**

sifone cilindrico cromo  
chrome siphon

**ACA022** 1 - - **130**

sifone cilindrico - siphon

**ACA099** ◎ 05 1 - - **180**

**ACA099** ● 17 1 - - **180**

# WON



Scopri la online  
Discover it online

Collezione di lavabi sospesi,  
da appoggio e per colonna/  
struttura

Collection of countertop,  
wall-hung and for column/  
structure washbasins



## WASHBASINS COLLECTION

A fluid and iconic design.  
The Won collection represents a new chapter in the evolution of sink design, inspired by the “bold” profile that made the award-winning Brera collection famous. While the latter marked a bold innovation by introducing generous and defined profiles in ceramics, Won reinterprets this language with its own delicate touch, offering a design that is fluid yet still iconic. The “bold” profile drops straight and determined, but never turns into a “border,” blending seamlessly with the sink surface to create a harmonious and contemporary effect.

# Un design fluido e iconico.

La collezione Won rappresenta un nuovo capitolo nell'evoluzione del design del lavabo, ispirata al profilo “bold” che ha reso celebre la premiata collezione Brera. Se quest'ultima ha segnato un'innovazione audace, introducendo profili generosi e marcati nella ceramica, Won ne interpreta il linguaggio con una delicatezza tutta sua, per un design più fluido ma comunque iconico. Il profilo “bold” scende così dritto e deciso, ma senza mai diventare un “bordo”, fondendosi perfettamente con la superficie del lavabo, creando un effetto armonioso e contemporaneo.

## **WNL001 | 55 x 37**

Lavabo appoggio  
*Countertop washbasin*

## **WNL002 | Ø 44**

Lavabo appoggio  
*Countertop washbasin*

## **WNL003 | 55 x 43**

Lavabo sospeso/appoggio  
*Wall-hung/countertop washbasin*

## **WNL004 | 48 x 44**

Lavabo sospeso/appoggio  
*Wall-hung/countertop washbasin*



WNL001 | 55 x 37  
Lavabo appoggio  
Countertop washbasin



The decorative element, which was the main feature in Brera, here becomes more subtle, whispered, yet equally distinctive. With Won, The.Artceram continues to amaze by renewing the language of ceramics and bringing the beauty of design to new levels of refinement. A perfect balance between audacity and elegance, transforming the sink into not just a functional element, but also an iconic one, capable of adding character and style to any bathroom.

L'elemento decorativo, che in Brera era protagonista, qui si fa più discreto, sussurrato, eppure altrettanto distintivo. Con Won, The.Artceram continua a sorprendere, rinnovando il linguaggio della ceramica e portando la bellezza del design a nuovi livelli di raffinatezza. Un perfetto equilibrio tra audacia e eleganza che trasforma il lavabo in un elemento non solo funzionale, ma anche iconico, capace di donare carattere e stile a ogni bagno.



A sinistra / On the left:

**WNL002 | Ø 44**

Lavabo appoggio  
Countertop washbasin



**WNL003 | 55 x 43**

Lavabo sospeso/appoggio  
Wall-hung/countertop washbasin



A destra / On the right:

**WNL004 | 48 x 44**

Lavabo sospeso/appoggio  
Wall-hung/countertop washbasin

**WNL003 | 55 x 43**

Lavabo sospeso/appoggio  
Wall-hung/countertop washbasin



WNL002 + BRC001 | Ø 44

Lavabo appoggio  
con colonna  
Countertop washbasin  
with column



## WON SYSTEM

I lavabi Won sono pensati per essere installati in diversi modi. Oltre alle classiche soluzioni da appoggio o sospeso, possono essere installati sulla colonna Brera, in appoggio sulle strutture metalliche ed anche sui mobili contenitori freestanding dedicati.

*Won washbasins are designed to be installed in different ways. In addition to the classic countertop or wall-hung solutions, they can be installed on the Brera column, resting on the metal structures and also on the dedicated freestanding storage units.*

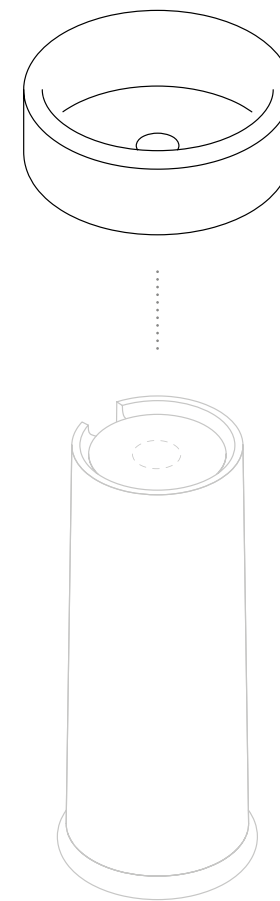

### COLONNA BRERA BRERA COLUMN

Monta i lavabi d'appoggio  
tondo e ovale

*Fits the oval and round  
countertop washbasins*

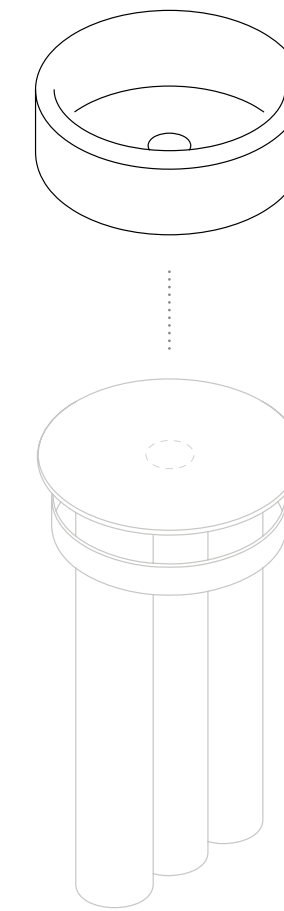

### STRUTTURE STRUCTURES

Verifica la compatibilità di installazione per i lavabi da appoggio tondo e ovale di Won sulle nostre strutture o mobili a pag. 94

*Check the installation compatibility for Won round and oval countertop washbasins on our structures or furniture at page 94*

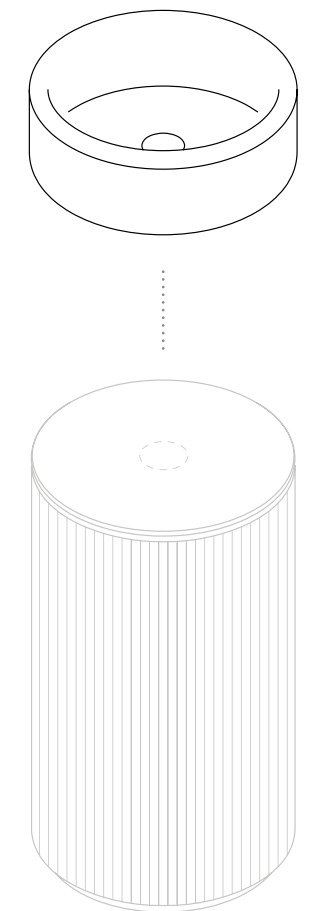

### MOBILI STORAGES

# WON STYLES

## CLASSIC COLORS



cod. 01  
bianco lucido / glossy white



cod. 05  
bianco matt / matt white



cod. 17  
nero matt / matt black

## MATT COLORS



cod. 15  
grigio oliva / grey olive



cod. 38  
blu avio / blue avio



cod. 41  
marrone matera / brown matera



cod. 59  
sabbia / sand



cod. 60  
ghiaia / gravel

## GLOSSY COLORS



cod. 67  
curcuma / turmeric



cod. 68  
paprika / paprika



cod. 69  
edera / ivy



cod. 70  
zefiro / zephyr

# WON OVERVIEW



THE SANIGLAZE

## WON | 55 x 37

lavabo appoggio senza foro  
rubinetto, con Saniglaze

countertop washbasin  
without tap hole, with Saniglaze



schede tecniche  
technical drawing

codice	colore	kg	pz. pallet Italia	pz. pallet Export	euro
CLASSIC COLORS					
WNL001	01	34	11	-	380
WNL001	05	34	11	-	650
WNL001	17	34	11	-	650
MATT COLORS					
WNL001		34	11	-	650
GLOSSY COLORS					
WNL001		34	11	-	650



THE SANIGLAZE

## WON | Ø 44

lavabo appoggio senza foro  
rubinetto, con Saniglaze

countertop washbasin  
without tap hole, with Saniglaze



schede tecniche  
technical drawing

codice	colore	kg	pz. pallet Italia	pz. pallet Export	euro
CLASSIC COLORS					
WNL002	01	34	11	-	370
WNL002	05	34	11	-	630
WNL002	17	34	11	-	630
MATT COLORS					
WNL002		34	11	-	630
GLOSSY COLORS					
WNL002		34	11	-	630

WASHBASINS

# WON OVERVIEW



THE SANIGLAZE

## WON | 55 x 43

lavabo sospeso/appoggio con foro rubinetto, con Saniglaze

wall-hung/countertop washbasin with tap hole, with Saniglaze



schede tecniche  
technical drawing

codice	colore	kg	pz. pallet Italia	pz. pallet Export	euro
CLASSIC COLORS					
WNL003	01; 34	15	-	-	390
WNL003	05; 34	15	-	-	660
WNL003	17; 34	15	-	-	660
MATT COLORS					
WNL003		34	15	-	660
GLOSSY COLORS					
WNL003		34	15	-	660

\* tasselli per fissaggio lavabi sospesi, non inclusi con il lavabo

ACA007		0,3	-	-	15
--------	--	-----	---	---	----

fitting system kit for wall-hung washbasins, not included with the washbasin



THE SANIGLAZE

## WON | 48 x 44

lavabo sospeso/appoggio con foro rubinetto dx/sx, con Saniglaze

wall-hung/countertop washbasin with tap hole right/left, with Saniglaze



schede tecniche  
technical drawing

codice	colore	kg	pz. pallet Italia	pz. pallet Export	euro
CLASSIC COLORS					
WNL004	01; 34	13	-	-	380
WNL004	05; 34	13	-	-	650
WNL004	17; 34	13	-	-	650
MATT COLORS					
WNL004		34	13	-	650
GLOSSY COLORS					
WNL004		34	13	-	650

\* tasselli per fissaggio lavabi sospesi, non inclusi con il lavabo

ACA007		0,3	-	-	15
--------	--	-----	---	---	----

fitting system kit for wall-hung washbasins, not included with the washbasin

# WON ACCESSORIES

piletta universale up & down cromo

chrome up & down drain

piletta universale up & down con tappo in ceramica, con Saniglaze

up & down universal drain with ceramic cover for washbasins, with Saniglaze

piletta cromo con troppo pieno integrato  
chrome drain with integral overflow

piletta con tappo in ceramica e troppo pieno integrato, con Saniglaze

drain with ceramic cover and integral overflow, with Saniglaze

sifone cilindrico cromo  
chrome siphon

sifone cilindrico - siphon

codice	colore	kg	pz. pallet Italia	pz. pallet Export	euro
ACA032		0,3	-	-	75
CLASSIC COLORS					
ACA036	01; 34	0,3	-	-	80
ACA038	05; 34	0,3	-	-	90
ACA038	17; 34	0,3	-	-	90
MATT COLORS					
ACA038		34	0,3	-	90
GLOSSY COLORS					
ACA038		34	0,3	-	90

ACA096		0,3	-	-	85
--------	--	-----	---	---	----

codice	colore	kg	pz. pallet Italia	pz. pallet Export	euro
CLASSIC COLORS					
ACA097	01; 34	0,3	-	-	90
ACA097	05; 34	0,3	-	-	90
ACA097	17; 34	0,3	-	-	90
MATT COLORS					
ACA097		34	0,3	-	90
GLOSSY COLORS					
ACA097		34	0,3	-	90

ACA022		1	-	-	130
--------	--	---	---	---	-----

ACA099	05	1	-	-	180
ACA099	17	1	-	-	180

# WHI SKY



Scopri la online  
Discover it online

Collezione  
di lavabi d'appoggio

Countertop  
washbasin collection



WASHBASINS

# WASHBASINS COLLECTION

## Embracing Shapes.

The countertop basins of the Whisky collection represent a functional and refined evolution of the Cognac thin-edged basins. Inspired by the generous and rounded shapes of the famous tasting glasses, these ceramic basins stand out for their balance between contemporary aesthetics and a high degree of functionality, allowing for the integration of faucets.

# Forme avvolgenti.

I lavabi da appoggio della collezione Whisky rappresentano una funzionale e raffinata evoluzione dei lavabi a bordo fino Cognac. Ispirati alle forme generose e tondeggianti dei celebri bicchieri da degustazione, questi lavabi in ceramica si distinguono per il loro equilibrio tra un'estetica contemporanea e un ottimo grado di funzionalità, che permette di alloggiare la rubinetteria.

WHL001 | 45 x 45

Lavabo appoggio  
Countertop washbasin

WHL002 | 60 x 45

Lavabo appoggio  
Countertop washbasin



WHL002 | 60 x 45  
Lavabo appoggio  
Countertop washbasin



WHL001 | 45 x 45  
Lavabo appoggio  
Countertop washbasin



The soft and enveloping lines of the basins evoke a sense of discreet luxury, while the ceramic surface, treated with advanced techniques, ensures long-lasting durability and easy maintenance. Each piece in the collection is the result of meticulous craftsmanship, where tradition merges with innovation to offer a unique and distinctive product.

Le linee morbide e avvolgenti dei lavabi evocano un senso di lusso discreto, mentre la superficie ceramica, trattata con tecniche avanzate, garantisce una lunga durata nel tempo e una facile manutenzione. Ogni pezzo della collezione è il risultato di un'attenta lavorazione artigianale, dove la tradizione si fonde con l'innovazione per offrire un prodotto unico e distintivo.

**WHL003 | 53 x 42**  
 Lavabo appoggio  
 Countertop washbasin



# WHISKY STYLES

## CLASSIC COLORS



bianco lucido / glossy white



bianco matt / matt white



nero matt / matt black

## MATT COLORS



grigio oliva / grey olive



blu avio / blue avio



marrone matera / brown matera



sabbia / sand



ghiaia / gravel

## GLOSSY COLORS



curcuma / turmeric



paprika / paprika



edera / ivy



zefiro / zephyr

WASHBASINS

# WHISKY OVERVIEW



THE.  
SANIGLAZE

## WHISKY 45 | 45 x 45

lavabo appoggio, con Saniglaze

countertop washbasin,  
with Saniglaze



schede tecniche  
technical drawing

codice	colore	kg	pz. pallet Italia	pz. pallet Export	euro	
CLASSIC COLORS						
WHL001	○ 01; 34	11	24	48	350	
WHL001	◎ 05; 34	11	24	48	580	
WHL001	● 17; 34	11	24	48	580	
MATT COLORS						
WHL001		34	11	24	48	580
GLOSSY COLORS						
WHL001		34	11	24	48	580



THE.  
SANIGLAZE

## WHISKY 53 | 53 x 42

lavabo appoggio, con Saniglaze

countertop washbasin,  
with Saniglaze



schede tecniche  
technical drawing

codice	colore	kg	pz. pallet Italia	pz. pallet Export	euro	
CLASSIC COLORS						
WHL003	○ 01; 34	13	20	40	370	
WHL003	◎ 05; 34	13	20	40	620	
WHL003	● 17; 34	13	20	40	620	
MATT COLORS						
WHL003		34	13	20	40	620
GLOSSY COLORS						
WHL003		34	13	20	40	620



THE.  
SANIGLAZE

## WHISKY 60 | 60 x 45

lavabo appoggio, con Saniglaze

countertop washbasin,  
with Saniglaze



schede tecniche  
technical drawing

codice	colore	kg	pz. pallet Italia	pz. pallet Export	euro	
CLASSIC COLORS						
WHL002	○ 01; 34	14	20	40	390	
WHL002	◎ 05; 34	14	20	40	650	
WHL002	● 17; 34	14	20	40	650	
MATT COLORS						
WHL002		34	14	20	40	650
GLOSSY COLORS						
WHL002		34	14	20	40	650

# WHISKY ACCESSORIES

piletta universale  
up & down cromo

chrome up & down drain

piletta universale up & down  
con tappo in ceramica,  
con Saniglaze

up & down universal drain with  
ceramic cover for washbasins,  
with Saniglaze

piletta cromo con troppo pieno  
integrato

chrome drain with integral  
overflow

piletta con tappo in ceramica  
e troppo pieno integrato,  
con Saniglaze

drain with ceramic cover  
and integral overflow,  
with Saniglaze

codice	colore	kg	pz. pallet Italia	pz. pallet Export	euro
ACA032		0,3	-	-	75
CLASSIC COLORS					
ACA036	○ 01; 34	0,3	-	-	80
ACA038	◎ 05; 34	0,3	-	-	90
ACA038	● 17; 34	0,3	-	-	90
MATT COLORS					
ACA038		34	0,3	-	90
GLOSSY COLORS					
ACA038		34	0,3	-	90

codice	colore	kg	pz. pallet Italia	pz. pallet Export	euro
ACA096		0,3	-	-	85
CLASSIC COLORS					
ACA097	○ 01; 34	0,3	-	-	90
ACA097	◎ 05; 34	0,3	-	-	90
ACA097	● 17; 34	0,3	-	-	90
MATT COLORS					
ACA097		34	0,3	-	90
GLOSSY COLORS					
ACA097		34	0,3	-	90

# COGNAC /COGNAC QUADRO



Scopri-la online  
Discover it online

Collezione di lavabi  
da appoggio

Countertop washbasins  
collection



# WASHBASINS COLLECTION

Iconic touches of style.  
We drew inspiration from the enveloping shape of cognac glasses, from which the collection takes its name, transforming this sensory lightness into a line of design oriented washbasins. All countertop models are made of Saniglaze ceramic and feature a thin 5 mm rim, enhancing the surfaces and lending harmony to the form.

# Iconici gesti di stile.

Abbiamo preso ispirazione dalla forma avvolgente dei bicchieri da cognac, da cui deriva il nome, trasformando questa leggerezza sensoriale in una collezione di lavabi di design. Tutti i modelli da appoggio sono realizzati in ceramica Saniglaze e presentano un bordo sottile di soli 5 mm, che esalta le superfici e conferisce armonia alla forma.

COL001 | Ø 42

Lavabo appoggio  
Countertop washbasin



COL001 | Ø 42

Lavabo appoggio  
Countertop washbasin



Available in five different sizes, the basins offer versatile design solutions, suitable for bathrooms of any size and style. The smooth lines and the minimal profile keep the design essential yet refined, turning the bathroom into a welcoming and elegant space. Attention to detail and balanced proportions ensure functionality without compromising style, making each basin a distinctive element capable of harmonizing with different materials and furnishings.

WASHBASINS

Disponibili in cinque diverse misure, i lavabi offrono soluzioni progettuali versatili, adatte a bagni di ogni dimensione e stile. Le linee morbide ed il profilo ridotto al minimo mantengono il design essenziale ma raffinato, trasformando lo spazio bagno in un ambiente accogliente ed elegante. La cura dei dettagli e le proporzioni equilibrate assicurano funzionalità senza sacrificare lo stile, rendendo ogni lavabo un elemento distintivo, pronto a dialogare con materiali e arredi differenti.

A destra / On the right:

**COL002 | Ø 48**

Lavabo appoggio  
Countertop washbasin



**COL004 | Ø 35**

Lavabo appoggio  
Countertop washbasin



**COL003 | 55 x 35**  
Lavabo appoggio  
Countertop washbasin  
edera / ivy

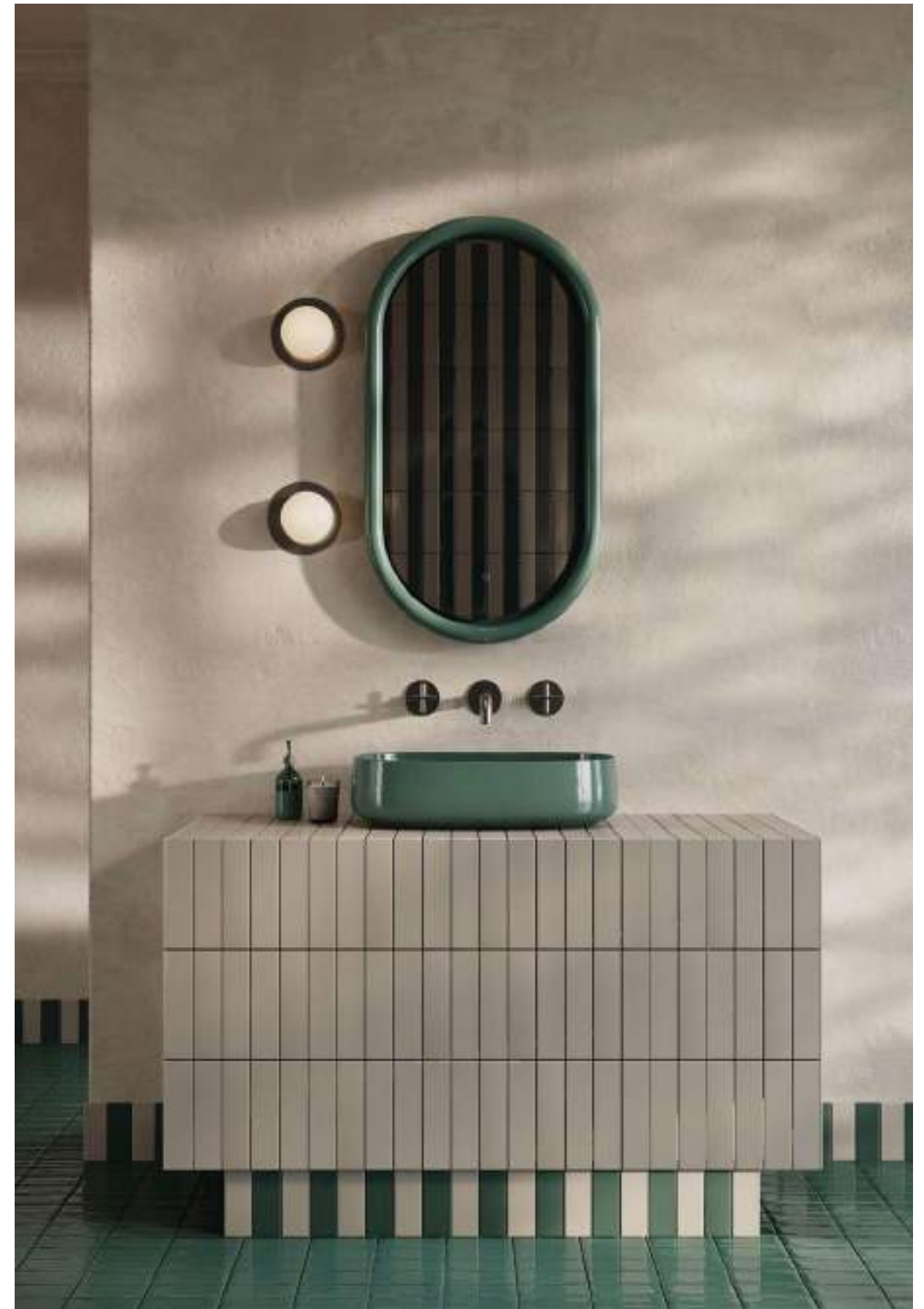



**COL005 | 68 x 35**  
Lavabo appoggio  
Countertop washbasin



Natural evolution of form.  
Since 2019, the best-selling collection has expanded with Cognac Quadro, the natural evolution of the original series. The volumes are larger and more defined, slightly squared, with a visually stronger character compared to the original line. All countertop basins are still made of The.Saniglaze ceramic and are available in four sizes, ideal for versatile design solutions and bathroom spaces with greater impact.

# Naturale evoluzione della forma.

Dal 2019 la collezione best-seller si amplia con Cognac Quadro, la naturale evoluzione della serie originale. I volumi sono più ampi e definiti, leggermente squadriati, con un carattere visivamente più deciso rispetto alla linea madre. Tutti i lavabi da appoggio sono sempre realizzati in ceramica con trattamento The.Saniglaze, e disponibili in quattro misure, ideali per soluzioni progettuali versatili e ambienti bagno di maggiore impatto.

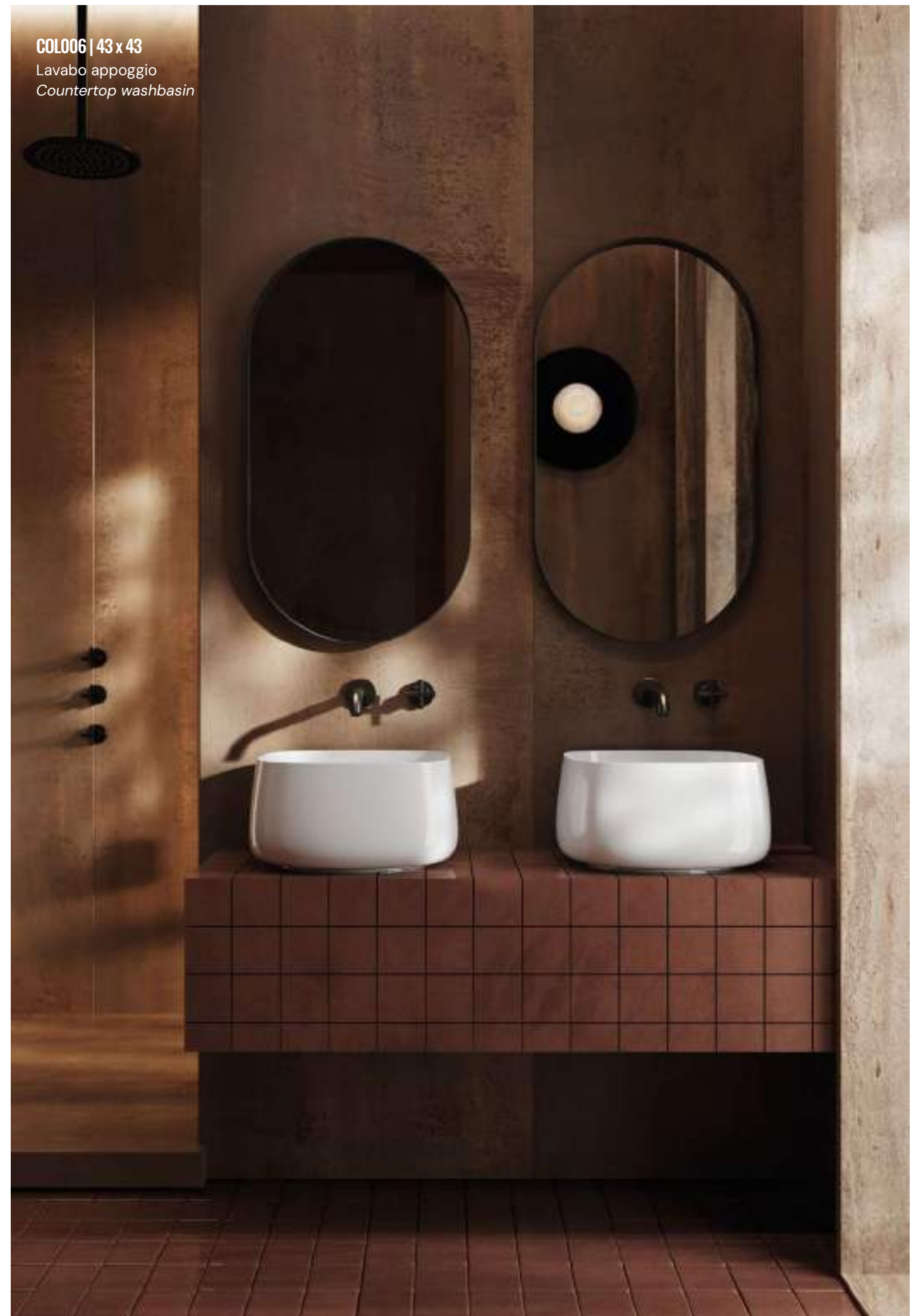

**COL006 | 43 x 43**

Lavabo appoggio  
Countertop washbasin



Le superfici levigate e le linee nette accentuano la solidità dei volumi, mentre il design minimale mantiene equilibrio e armonia. Cognac Quadro trasforma il bagno in uno spazio elegante e ordinato, portando raffinatezza e presenza scenica senza perdere la funzionalità, rendendo i lavabi protagonisti distintivi e riconoscibili all'interno di qualsiasi progetto.

The smooth surfaces and clean lines emphasize the solidity of the volumes, while the minimalist design maintains balance and harmony. Cognac Quadro transforms the bathroom into an elegant and orderly space, bringing refinement and visual presence without compromising functionality, making the basins distinctive and recognizable elements within any project.

**COL007 | 46 x 41**

Lavabo appoggio  
Countertop washbasin  
curcuma / turmeric





**COL008 | 55 x 35**  
Lavabo appoggio  
Countertop washbasin



# COGNAC & COGNAC QUADRO STYLES



## CLASSIC COLORS



bianco lucido / glossy white



bianco matt / matt white



nero matt / matt black

## MATT COLORS



grigio oliva / grey olive



blu avio / blue avio



marrone matera / brown matera



sabbia / sand



ghiaia / gravel

## GLOSSY COLORS



curcuma / turmeric



paprika / paprika



edera / ivy



zefiro / zephyr

# COGNAC OVERVIEW



THE SANIGLAZE

## COGNAC 42 | Ø 42

lavabo appoggio, con Saniglaze

countertop washbasin,  
with Saniglaze



schede tecniche  
technical drawing

codice	colore	kg	pz. pallet Italia	pz. pallet Export	euro	
CLASSIC COLORS						
COL001	○ 01; 34	9	26	52	305	
COL001	◎ 05; 34	9	26	52	515	
COL001	● 17; 34	9	26	52	515	
MATT COLORS						
COL001		34	9	26	52	515
GLOSSY COLORS						
COL001		34	9	26	52	515

# COGNAC OVERVIEW



THE SANIGLAZE

## COGNAC 55 | 55 x 35

lavabo appoggio, con Saniglaze

countertop washbasin,  
with Saniglaze



schede tecniche  
technical drawing

codice	colore	kg	pz. pallet Italia	pz. pallet Export	euro	
CLASSIC COLORS						
COL003	○ 01; 34	10	20	40	370	
COL003	◎ 05; 34	10	20	40	620	
COL003	● 17; 34	10	20	40	620	
MATT COLORS						
COL003		34	10	20	40	620
GLOSSY COLORS						
COL003		34	10	20	40	620



THE SANIGLAZE

## COGNAC 48 | Ø 48

lavabo appoggio, con Saniglaze

countertop washbasin,  
with Saniglaze



schede tecniche  
technical drawing

codice	colore	kg	pz. pallet Italia	pz. pallet Export	euro	
CLASSIC COLORS						
COL002	○ 01; 34	11	26	44	330	
COL002	◎ 05; 34	11	26	44	560	
COL002	● 17; 34	11	26	44	560	
MATT COLORS						
COL002		34	11	26	44	560
GLOSSY COLORS						
COL002		34	11	26	44	560



THE SANIGLAZE

## COGNAC 35 | Ø 35

lavabo appoggio, con Saniglaze

countertop washbasin,  
with Saniglaze



schede tecniche  
technical drawing

codice	colore	kg	pz. pallet Italia	pz. pallet Export	euro	
CLASSIC COLORS						
COL004	○ 01; 34	7	28	52	295	
COL004	◎ 05; 34	7	28	52	495	
COL004	● 17; 34	7	28	52	495	
MATT COLORS						
COL004		34	7	28	52	495
GLOSSY COLORS						
COL004		34	7	28	52	495

# COGNAC OVERVIEW



THE SANIGLAZE

## COGNAC 68 | 68 x 35

lavabo appoggio, con Saniglaze

countertop washbasin,  
with Saniglaze



schede tecniche  
technical drawing

codice	colore	kg	pz. pallet Italia	pz. pallet Export	euro	
CLASSIC COLORS						
COL005	○ 01; 34	13	20	40	395	
COL005	◎ 05; 34	13	20	40	675	
COL005	● 17; 34	13	20	40	675	
MATT COLORS						
COL005		34	13	20	40	675
GLOSSY COLORS						
COL005		34	13	20	40	675

# COGNAC QUADRO OVERVIEW



THE SANIGLAZE

## COGNAC QUADRO 43 43 x 43 h 22,5

lavabo appoggio, con Saniglaze

countertop washbasin,  
with Saniglaze



schede tecniche  
technical drawing

codice	colore	kg	pz. pallet Italia	pz. pallet Export	euro	
CLASSIC COLORS						
COL006	○ 01; 34	14	22	40	330	
COL006	◎ 05; 34	14	22	40	560	
COL006	● 17; 34	14	22	40	560	
MATT COLORS						
COL006		34	14	22	40	560
GLOSSY COLORS						
COL006		34	14	22	40	560



THE SANIGLAZE

## COGNAC QUADRO 46 46 X 41 h 15,5

lavabo appoggio, con Saniglaze

countertop washbasin,  
with Saniglaze



schede tecniche  
technical drawing

codice	colore	kg	pz. pallet Italia	pz. pallet Export	euro	
CLASSIC COLORS						
COL007	○ 01; 34	11	24	50	360	
COL007	◎ 05; 34	11	24	50	610	
COL007	● 17; 34	11	24	50	610	
MATT COLORS						
COL007		34	11	24	50	610
GLOSSY COLORS						
COL007		34	11	24	50	610

# COGNAC QUADRO OVERVIEW



THE.  
SANIGLAZE

## COGNAC QUADRO 55 55 x 35 h 15,5

lavabo appoggio, con Saniglaze

countertop washbasin,  
with Saniglaze



schede tecniche  
technical drawing

codice	colore	kg	pz. pallet Italia	pz. pallet Export	euro	
CLASSIC COLORS						
COL008	○ 01; 34	11	20	40	380	
COL008	◎ 05; 34	11	20	40	650	
COL008	● 17; 34	11	20	40	650	
MATT COLORS						
COL008		34	11	20	40	650
GLOSSY COLORS						
COL008		34	11	20	40	650



THE.  
SANIGLAZE

## COGNAC QUADRO 56 56 x 41 h 15,5

lavabo appoggio, con Saniglaze

countertop washbasin,  
with Saniglaze



schede tecniche  
technical drawing

codice	colore	kg	pz. pallet Italia	pz. pallet Export	euro	
CLASSIC COLORS						
COL009	○ 01; 34	13	20	40	425	
COL009	◎ 05; 34	13	20	40	720	
COL009	● 17; 34	13	20	40	720	
MATT COLORS						
COL009		34	13	20	40	720
GLOSSY COLORS						
COL009		34	13	20	40	720

# COGNAC & COGNAC QUADRO ACCESSORIES

piletta universale  
up & down cromo

chrome up & down drain

piletta universale up & down  
con tappo in ceramica,  
con Saniglaze

up & down universal drain with  
ceramic cover for washbasins,  
with Saniglaze

piletta cromo con troppo pieno  
integrato

chrome drain with integral  
overflow

piletta con tappo in ceramica  
e troppo pieno integrato,  
con Saniglaze

drain with ceramic cover  
and integral overflow,  
with Saniglaze

codice	colore	kg	pz. pallet Italia	pz. pallet Export	euro	
ACA032		0,3	-	-	75	
CLASSIC COLORS						
ACA036	○ 01; 34	0,3	-	-	80	
ACA038	◎ 05; 34	0,3	-	-	90	
ACA038	● 17; 34	0,3	-	-	90	
MATT COLORS						
ACA038		34	0,3	-	-	90
GLOSSY COLORS						
ACA038		34	0,3	-	-	90

codice	colore	kg	pz. pallet Italia	pz. pallet Export	euro	
ACA096		0,3	-	-	85	
CLASSIC COLORS						
ACA097	○ 01; 34	0,3	-	-	90	
ACA097	◎ 05; 34	0,3	-	-	90	
ACA097	● 17; 34	0,3	-	-	90	
MATT COLORS						
ACA097		34	0,3	-	-	90
GLOSSY COLORS						
ACA097		34	0,3	-	-	90

# RO DOOL FO



Scopri la online  
Discover it online

Collezione  
di lavabi sospesi e d'appoggio

Wall-hung and countertop  
washbasins collection



## WASHBASINS COLLECTION

Strong Lines, Gentle Details.

The Rodolfo collection defines a series of “square” basins characterized by their distinctive edge and flexibility of use. The basins are designed to offer versatility and style without compromise; they are intended for high-traffic environments where durability, functionality, and aesthetic design are essential! The Rodolfo basins feature compact and orthogonal shapes, enhanced by rounded corners and significant thicknesses.

# Linee forti, dettagli gentili.

La collezione Rodolfo definisce una collezione di lavabi “quadrati” caratterizzati dal loro bordo distintivo e per la loro flessibilità di utilizzo. I lavabi sono progettati per offrire versatilità e stile senza compromessi; sono stati pensati per ambienti ad “alto traffico”, dove durabilità, funzionalità e design estetico sono essenziali! I lavabi Rodolfo hanno forme compatte e ortogonali, arricchiti da angoli arrotondati e spessori rilevanti.

## **ROL001 | 80 x 45**

Lavabo sospeso/appoggio  
Wall-hung/countertop washbasin

## **ROL002 | 60 x 45**

Lavabo sospeso/appoggio  
Wall-hung/countertop washbasin

## **ROL003 | 50 x 45**

Lavabo sospeso/appoggio  
Wall-hung/countertop washbasin

## **ROL004 | 40 x 38**

Lavabo sospeso/appoggio  
Wall-hung/countertop washbasin



**ROL001 | 80 x 45**

Lavabo sospeso/appoggio  
Wall-hung/countertop washbasin



**ROL006 | 120 x 45**

Lavabo sospeso/appoggio  
con doppia vasca  
Wall-hung/countertop  
with double-bowl washbasin

A distinctive detail of the collection is the 45° inclination of the edges that gently slope into the basin, a key element that creates a harmonious fil-rouge among all models. This detail elegantly blends into the countertop area that houses the faucet and also provides a practical and functional space for placing everyday accessories. This feature makes the Rodolfo basins extremely versatile and suitable for any space requirement.

Un dettaglio distintivo della collezione è l'inclinazione a 45° dei bordi che scendono delicatamente nella vasca, elemento chiave che crea un armonioso fil-rouge tra tutti i modelli. Questo particolare si fonde elegantemente nella zona di appoggio che ospita la rubinetteria e che offre anche uno spazio pratico e funzionale per posizionare accessori di uso quotidiano. Tale caratteristica rende i lavabi Rodolfo estremamente versatili e adatti a qualsiasi esigenza di spazio.



**ROL004 | 40 x 38**  
Lavabo sospeso/appoggio  
Wall-hung/countertop washbasin



**ROL003 | 50 x 45**  
Lavabo sospeso/appoggio  
Wall-hung/countertop washbasin



**ROL002 | 60 x 45**  
Lavabo sospeso/appoggio  
Wall-hung/countertop washbasin

**ROL005 | 100 x 45**

Lavabo sospeso/appoggio

Wall-hung/countertop washbasin



WASHBASINS

## RODOLFO STYLES

### CLASSIC COLORS



bianco lucido / glossy white



bianco matt / matt white



nero matt / matt black

# RODOLFO OVERVIEW



THE SANIGLAZE

## RODOLFO 40 | 40 x 38

lavabo sospeso/appoggio  
1 foro, con Saniglaze

wall-hung/countertop  
washbasin 1 hole, with Saniglaze



schede tecniche  
technical drawing

codice	colore	kg	pz. pallet Italia	pz. pallet Export	euro
CLASSIC COLORS					
ROLO04	○ 01; 34	12	28	52	300
ROLO04	◎ 05; 34	12	28	52	450
ROLO04	● 17; 34	12	28	52	450

\* tasselli per fissaggio lavabi sospesi, non inclusi con il lavabo

ACA007 0,3 - - 15

fitting system kit for wall-hung washbasins, not included with the washbasin



THE SANIGLAZE

## RODOLFO 50 | 50 x 45

lavabo sospeso/appoggio  
1 foro (predisposto 3 fori), con Saniglaze

wall-hung/countertop  
washbasin 1 hole with arrangements for 3 holes, with Saniglaze



schede tecniche  
technical drawing

codice	colore	kg	pz. pallet Italia	pz. pallet Export	euro
CLASSIC COLORS					
ROLO03	○ 01; 34	17	24	48	320
ROLO03	◎ 05; 34	17	24	48	480
ROLO03	● 17; 34	17	24	48	480

\* tasselli per fissaggio lavabi sospesi, non inclusi con il lavabo

ACA007 0,3 - - 15

fitting system kit for wall-hung washbasins, not included with the washbasin

\*

Il tappo del troppopieno è coordinato al colore della ceramica, ad eccezione della versione in ceramica bianca lucida, abbinata a tappo cromo.

\*

The overflow cover is matched to the ceramic color, except for the glossy white ceramic version, which is paired with a chrome cover.

# RODOLFO OVERVIEW



THE SANIGLAZE

## RODOLFO 65 | 65 x 45

lavabo sospeso/appoggio  
1 foro (predisposto 3 fori), con Saniglaze

wall-hung/countertop  
washbasin 1 hole with arrangements for 3 holes, with Saniglaze



schede tecniche  
technical drawing

codice	colore	kg	pz. pallet Italia	pz. pallet Export	euro
CLASSIC COLORS					
ROLO02	○ 01; 34	22	20	33	360
ROLO02	◎ 05; 34	22	20	33	540
ROLO02	● 17; 34	22	20	33	540

\* tasselli per fissaggio lavabi sospesi, non inclusi con il lavabo

ACA007 0,3 - - 15

fitting system kit for wall-hung washbasins, not included with the washbasin



THE SANIGLAZE

## RODOLFO 80 | 80 x 45

lavabo sospeso/appoggio  
1 foro (predisposto 3 fori), con Saniglaze

wall-hung/countertop  
washbasin 1 hole with arrangements for 3 holes, with Saniglaze



schede tecniche  
technical drawing

codice	colore	kg	pz. pallet Italia	pz. pallet Export	euro
CLASSIC COLORS					
ROLO01	○ 01; 34	25	14	28	380
ROLO01	◎ 05; 34	25	14	28	570
ROLO01	● 17; 34	25	14	28	570

\* tasselli per fissaggio lavabi sospesi, non inclusi con il lavabo

ACA007 0,3 - - 15

fitting system kit for wall-hung washbasins, not included with the washbasin

# RODOLFO OVERVIEW



THE SANIGLAZE

## RODOLFO 100 | 100 x 45

lavabo sospeso/appoggio  
1 foro (predisposto 3 fori),  
con Saniglaze

wall-hung/countertop  
washbasin 1 hole with arrangements  
for 3 holes, with Saniglaze



schede tecniche  
technical drawing

codice	colore	kg	pz. pallet Italia	pz. pallet Export	euro
CLASSIC COLORS					
ROLO05	○ 01; 34	31	12	24	410
ROLO05	◎ 05; 34	31	12	24	615
ROLO05	● 17; 34	31	12	24	615

\* tasselli per fissaggio lavabi  
sospesi, non inclusi con il lavabo

ACA007		0,3	-	-	15
--------	--	-----	---	---	----

fitting system kit for wall-hung  
washbasins, not included  
with the washbasin



THE SANIGLAZE

## RODOLFO 120 | 120 x 45

lavabo sospeso/appoggio  
con doppia vasca 2 fori  
(predisposto 6 fori), con Saniglaze

wall-hung/countertop  
with double-bowl washbasin  
2 holes with arrangements  
for 6 holes, with Saniglaze



schede tecniche  
technical drawing

codice	colore	kg	pz. pallet Italia	pz. pallet Export	euro
CLASSIC COLORS					
ROLO06	○ 01; 34	36	10	20	430
ROLO06	◎ 05; 34	36	10	20	645
ROLO06	● 17; 34	36	10	20	645

\* tasselli per fissaggio lavabi  
sospesi, non inclusi con il lavabo

ACA007		0,3	-	-	15
--------	--	-----	---	---	----

fitting system kit for wall-hung  
washbasins, not included  
with the washbasin

# RODOLFO ACCESSORIES

piletta universale  
up & down cromo

codice	colore	kg	pz. pallet Italia	pz. pallet Export	euro
ACA032		0,3	-	-	75

chrome up & down drain

THE SANIGLAZE

piletta universale up & down  
con tappo in ceramica,  
con Saniglaze

codice	colore	kg	pz. pallet Italia	pz. pallet Export	euro
CLASSIC COLORS					
ACA036	○ 01; 34	0,3	-	-	80
ACA038	◎ 05; 34	0,3	-	-	90
ACA038	● 17; 34	0,3	-	-	90

up & down universal drain with  
ceramic cover for washbasins,  
with Saniglaze

piletta cromo con troppo pieno  
integrato

ACA096		0,3	-	-	85
--------	--	-----	---	---	----

chrome drain with integral  
overflow

THE SANIGLAZE

piletta con tappo in ceramica  
e troppo pieno integrato,  
con Saniglaze

codice	colore	kg	pz. pallet Italia	pz. pallet Export	euro
CLASSIC COLORS					
ACA097	○ 01; 34	0,3	-	-	90
ACA097	◎ 05; 34	0,3	-	-	90
ACA097	● 17; 34	0,3	-	-	90

drain with ceramic cover  
and integral overflow,  
with Saniglaze

sifone cilindrico cromo  
chrome siphon

ACA022		1	-	-	130
--------	--	---	---	---	-----

sifone cilindrico - siphon

ACA099	◎ 05	1	-	-	180
ACA099	● 17	1	-	-	180

# SCA LINO



Scopri la online  
Discover it online

Collezione di lavabi sospesi  
e d'appoggio

Wall-hung and countertop  
washbasins collection



# WASHBASINS COLLECTION

Essential, functional, uncompromising.  
The Scalino collection interprets the countertop and wall-hung washbasin as an object of essential design, characterized by clean lines and precise proportions. Its squared geometries emphasize simplicity, creating a sober and harmonious aesthetic, perfect for modern and refined bathroom settings.

# Essenziale, funzionale, senza compromessi.

La collezione Scalino interpreta il lavabo d'appoggio e sospeso come un oggetto dal design essenziale, caratterizzato da linee pulite e proporzioni rigorose. Le geometrie squadrate esaltano la semplicità del prodotto, offrendo un'estetica sobria e armoniosa, perfetta per ambienti bagno moderni e raffinati.

SCL008 | 75 X 48

Lavabo sospeso/appoggio

Wall-hung/countertop washbasin



SCL008 | 75 x 48

Lavabo sospeso/appoggio  
Wall-hung/countertop washbasin



SCL007 | 55 x 48

Lavabo sospeso/appoggio  
Wall-hung/countertop washbasin

The internal surfaces, flat yet designed with a subtle, virtually invisible slope, allow water to drain naturally while highlighting the basin's linearity and simplicity. The result is a minimal, functional product that integrates seamlessly into any contemporary bathroom project.

Le superfici interne piatte, progettate con una lieve pendenza invisibile ad occhio nudo, assicurano che l'acqua defluisca naturalmente, valorizzando al contempo la semplicità e la linearità del lavabo. Il risultato è un prodotto minimale, funzionale e facilmente integrabile in qualsiasi progetto bagno contemporaneo.

**SCL001 | 38 x 38**  
Lavabo appoggio  
Countertop washbasin

A destra / On the right:

**SCL002 | 38 x 55**  
Lavabo appoggio  
Countertop washbasin



**SCL005 | 38 x 27**

Lavabo sospeso/appoggio  
Wall-hung/countertop washbasin



A destra / On the right:

**SCL006 | 50 x 27**

Lavabo sospeso/appoggio  
Wall-hung/countertop washbasin



# SCALINO OVERVIEW



## SCALINO 38 | 38 x 38

codice	colore	kg	pz. pallet Italia	pz. pallet Export	euro
SCL001	○ 01; 00	8,5	26	54	240

lavabo appoggio

countertop washbasin



schede tecniche  
technical drawing

\* tasselli per fissaggio lavabi sospesi, non inclusi con il lavabo

ACA007	0,3	-	-	15
--------	-----	---	---	----

fitting system kit for wall-hung washbasins, not included with the washbasin



## SCALINO 55 | 38 x 55

codice	colore	kg	pz. pallet Italia	pz. pallet Export	euro
SCL002	○ 01; 00	13	18	20	295

lavabo appoggio

countertop washbasin



schede tecniche  
technical drawing

\* tasselli per fissaggio lavabi sospesi, non inclusi con il lavabo

ACA007	0,3	-	-	15
--------	-----	---	---	----

fitting system kit for wall-hung washbasins, not included with the washbasin

# SCALINO OVERVIEW



## SCALINO 38 | 38 x 27

codice	colore	kg	pz. pallet Italia	pz. pallet Export	euro
SCL005	○ 01; 00	8	50	108	225

lavabo sospeso/appoggio

wall-hung/countertop washbasin



schede tecniche  
technical drawing

\* tasselli per fissaggio lavabi sospesi, non inclusi con il lavabo

ACA007	0,3	-	-	15
--------	-----	---	---	----

fitting system kit for wall-hung washbasins, not included with the washbasin



## SCALINO 50 | 50 x 27

codice	colore	kg	pz. pallet Italia	pz. pallet Export	euro
SCL006	○ 01; 00	11	33	66	265

lavabo sospeso/appoggio

wall-hung/countertop washbasin



schede tecniche  
technical drawing

\* tasselli per fissaggio lavabi sospesi, non inclusi con il lavabo

ACA007	0,3	-	-	15
--------	-----	---	---	----

fitting system kit for wall-hung washbasins, not included with the washbasin

# SCALINO OVERVIEW



## SCALINO 55 | 55 x 48

codice	colore	kg	pz. pallet Italia	pz. pallet Export	euro
SCL007	○ 01; 00	16	18	3	305

lavabo sospeso/appoggio  
1 foro (predisposto tre fori)

*wall-hung/countertop washbasin  
1 hole with arrangement  
for 3 holes*



schede tecniche  
technical drawing

\* tasselli per fissaggio lavabi  
sospesi, non inclusi con il lavabo

ACA007		0,3	-	-	15
--------	--	-----	---	---	----

*fitting system kit for wall-hung  
washbasins, not included  
with the washbasin*



## SCALINO 75 | 75 x 48

codice	colore	kg	pz. pallet Italia	pz. pallet Export	euro
SCL008	○ 01; 00	18	12	20	360

lavabo sospeso/appoggio  
1 foro (predisposto tre fori)

*wall-hung/countertop washbasin  
1 hole with arrangement  
for 3 holes*



schede tecniche  
technical drawing

\* tasselli per fissaggio lavabi  
sospesi, non inclusi con il lavabo

ACA007		0,3	-	-	15
--------	--	-----	---	---	----

*fitting system kit for wall-hung  
washbasins, not included  
with the washbasin*

# SCALINO ACCESSORIES

	codice	colore	kg	pz. pallet Italia	pz. pallet Export	euro
piletta universale up & down cromo	ACA032		0,3	-	-	75

*chrome up & down drain*



piletta universale up & down  
con tappo in ceramica,  
con Saniglaze

ACA036	○ 01; 34	0,3	-	-	80
--------	----------	-----	---	---	----

*up & down universal drain with  
ceramic cover for washbasins,  
with Saniglaze*

piletta cromo con troppo pieno  
integrato

ACA096		0,3	-	-	85
--------	--	-----	---	---	----

*chrome drain with integral  
overflow*



piletta con tappo in ceramica  
e troppo pieno integrato,  
con Saniglaze

ACA097	○ 01; 34	0,3	-	-	90
--------	----------	-----	---	---	----

*drain with ceramic cover  
and integral overflow,  
with Saniglaze*

sifone cilindrico cromo  
*chrome siphon*

ACA022		1	-	-	130
--------	--	---	---	---	-----

# BRE RA

**archiproducts**  
AWARDS  
WINNER

Collezione di lavabi sospesi,  
da appoggio e per colonna/  
struttura

Collection of countertop,  
wall-hung and for column/  
structure washbasins



Scopri online  
Discover it online



# WASHBASINS COLLECTION

## Milanese Elegance.

The Brera neighbourhood is the beating heart of Milan's historic centre, known for its period buildings and elegant residences. Recognized worldwide as a landmark of international design, it embodies a refined balance between art, architecture, and style. Drawing inspiration from traditional déco canons and a classic idea of elegance - while looking to the future in concept, colour, and material - Meneghello Paoletti presents Brera, a sophisticated collection of both wall-hung and countertop washbasins.

# L'eleganza milanese.

Il quartiere di Brera è il cuore pulsante del centro storico di Milano, caratteristico per le case d'epoca e per l'eleganza delle sue abitazioni. In tutto il mondo è riconosciuto come distretto di riferimento del design internazionale. Ispirandosi ad alcuni canoni tradizionali del design déco e a un'idea più classica di eleganza, ma sempre guardando al futuro nel concept, nei colori e nei materiali, Meneghello Paoletti presenta Brera, una raffinata collezione di lavabi, sia da appoggio che sospesi.

### **BRL001 | Ø 43 h 15**

Lavabo appoggio tondo  
*Countertop round washbasin*

### **BRL002 | 60 x 45 h 15,5**

Lavabo appoggio  
*Countertop washbasin*

### **BRL003 | 60 x 40 h 15**

Lavabo appoggio ovale  
*Countertop oval washbasin*

### **BRL004 | 65 x 46 h 18**

Lavabo sospeso  
*Wall-hung washbasin*



**BRL001 + BRC001 | Ø 43 h 15**

Lavabo appoggio tondo  
e colonna dedicata  
*Countertop round washbasin  
and dedicated column*



**BRL001 | Ø 43 h 15**

Lavabo appoggio tondo  
*Countertop round washbasin*



A distinctive feature of the collection is the deliberate absence of a thin rim, replaced by a bold profile that defines its overall aesthetic. This design choice creates an intriguing undercut within the basin, giving the washbasins a sculptural presence and a strong personality—perfect for contemporary interiors that reflect the timeless spirit of Milanese design.

WASHBASINS

Elemento distintivo della collezione è la voluta assenza di un bordo sottile, sostituito da un profilo bold che ne definisce l'estetica generale. Questa scelta genera un interessante sottosquadro all'interno del catino, conferendo ai lavabi una presenza scultorea e un carattere deciso, perfetto per ambienti contemporanei che dialogano con la tradizione del design milanese.

# BRERA SYSTEM

I lavabi Brera sono pensati per essere installati in diversi modi. Oltre alle classiche soluzioni da appoggio o sospeso, possono essere installati sull'apposita colonna Brera, in appoggio sulle strutture metalliche ed anche sui mobili contenitori freestanding dedicati.

*Brera washbasins are designed to be installed in different ways. In addition to the classic countertop or wall-hung solutions, they can be installed on the specific Brera column, resting on the metal structures and also on the dedicated freestanding storage units.*

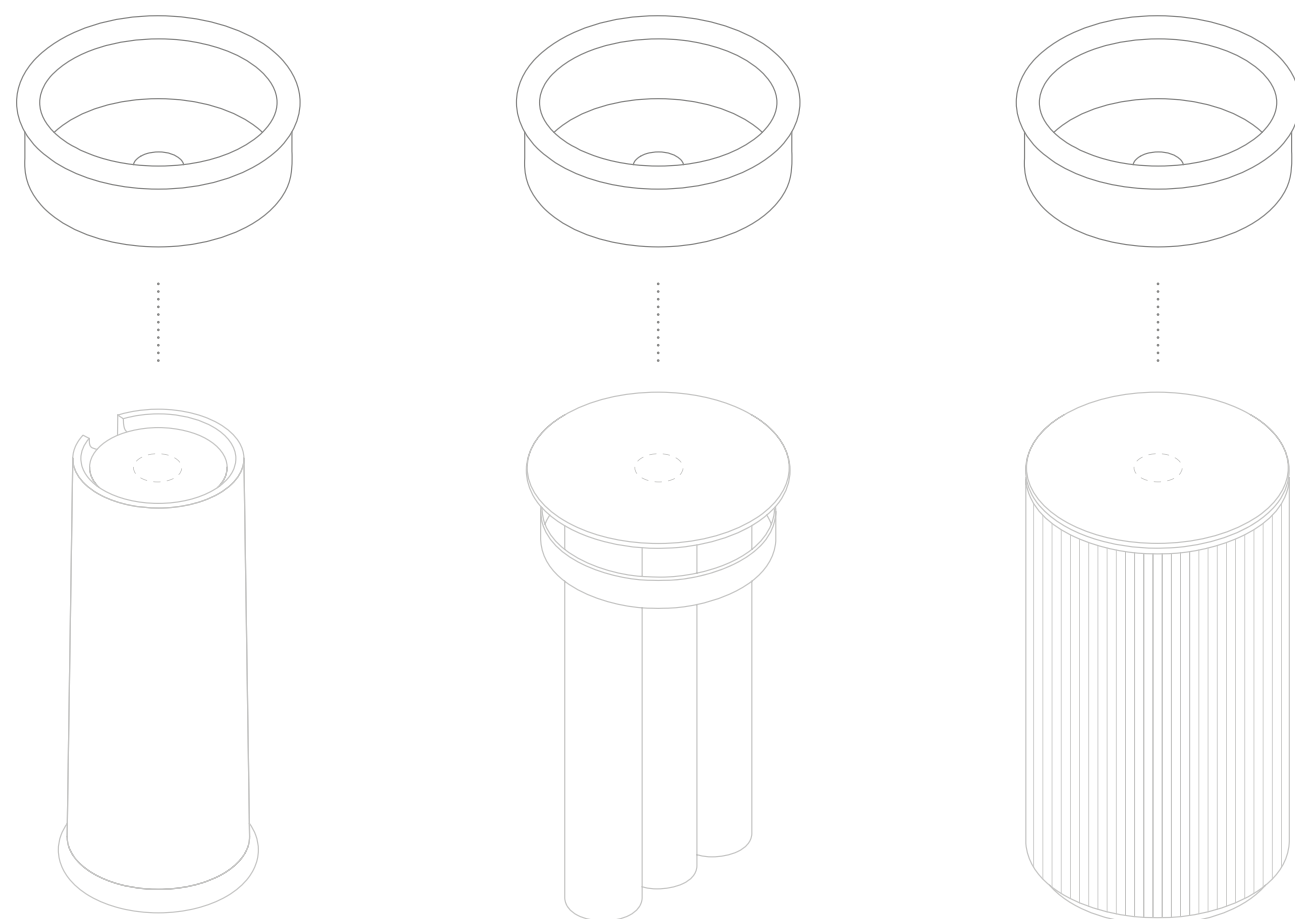

## COLONNA COLUMN

Monta tutti i 4 lavabi della collezione Brera

*Fits all 4 washbasins of the Brera collection*

## STRUTTURE STRUCTURES

Verifica la compatibilità di installazione per i lavabi da appoggio tondo e ovale di Brera sulle nostre strutture o mobili a pag. 94

*Check the installation compatibility for Brera round and oval countertop washbasins on our structures or furniture at page 94*

## MOBILI STORAGES

BRL003 + BRC001 | 60 x 40 h 15

Lavabo appoggio ovale e colonna dedicata  
*Countertop oval washbasin and dedicated column*



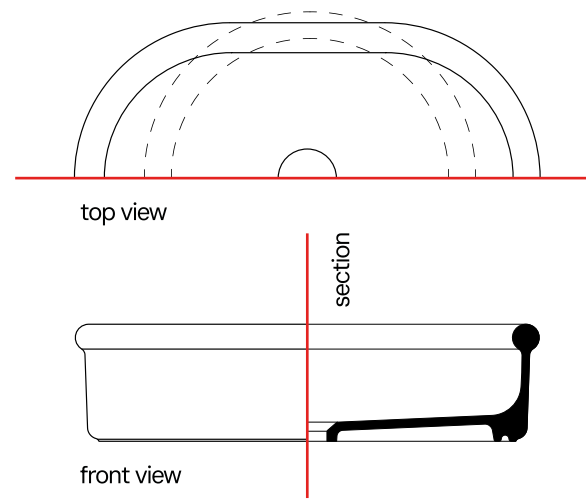

A destra / On the right:

**BRL002 | 60 x 45 h 15,5**  
 Lavabo appoggio  
 Countertop washbasin



**BRL003 | 60 x 40 h 15**  
 Lavabo appoggio ovale  
 Countertop oval washbasin



**BRL004 + BRA001 | 65 x 46 h 18**

Lavabo sospeso  
con staffa portasciugamani  
*Wall-hung washbasin  
with towel rail*



# BRERA STYLES

## CLASSIC COLORS



bianco lucido / glossy white



bianco matt / matt white



nero matt / matt black

## MATT COLORS



grigio oliva / grey olive



blu avio / blue avio



marrone matera / brown matera



sabbia / sand



ghiaia / gravel

## METALS



bianco matt / matt white  
RAL 9016



nero matt / matt black  
RAL 9005



moka / moka  
RAL 8014

# BRERA OVERVIEW



## BRERA | Ø 43 h 15

lavabo appoggio

countertop washbasin



schede tecniche  
technical drawing

codice	colore	kg	pz. pallet Italia	pz. pallet Export	euro
CLASSIC COLORS					
BRL001	○ 01; 00	10	26	52	380
BRL001	◎ 05; 00	10	26	52	590
BRL001	● 17; 00	10	26	52	590
MATT COLORS					
BRL001		10	26	52	590



## BRERA | 60 x 40 h 15

lavabo appoggio

countertop washbasin



schede tecniche  
technical drawing

codice	colore	kg	pz. pallet Italia	pz. pallet Export	euro
CLASSIC COLORS					
BRL003	○ 01; 00	14	18	36	390
BRL003	◎ 05; 00	14	18	36	620
BRL003	● 17; 00	14	18	36	620
MATT COLORS					
BRL003		14	18	36	620



## BRERA | 60 x 45 h 15,5

lavabo appoggio  
con foro rubinetto

countertop washbasin  
with taphole



schede tecniche  
technical drawing

codice	colore	kg	pz. pallet Italia	pz. pallet Export	euro
CLASSIC COLORS					
BRL002	○ 01; 00	15	18	36	400
BRL002	◎ 05; 00	15	18	36	650
BRL002	● 17; 00	15	18	36	650
MATT COLORS					
BRL002		15	18	36	650

\*

Il tappo del troppopieno è coordinato al colore della ceramica, ad eccezione della versione in ceramica bianca lucida, abbinata a tappo cromo.

\*

The overflow cover is matched to the ceramic color, except for the glossy white ceramic version, which is paired with a chrome cover.

# BRERA OVERVIEW



## BRERA | 65 x 46 h 18

lavabo sospeso  
con foro rubinetto

wall-hung washbasin  
with taphole



schede tecniche  
technical drawing

codice	colore	kg	pz. pallet Italia	pz. pallet Export	euro
CLASSIC COLORS					
BRL004	01; 00	17	18	36	430
BRL004	05; 00	17	18	36	680
BRL004	17; 00	17	18	36	680
MATT COLORS					
BRL004		17	18	36	680

\* tasselli per fissaggio lavabi sospesi, non inclusi con il lavabo

ACA007		0,3	-	-	15
--------	--	-----	---	---	----

fitting system kit for wall-hung washbasins, not included with the washbasin



## BRERA | 62

staffa portasciugamani per lavabo 65

towel rail for washbasin 65

METALS					
BRA001	05	1,5	-	-	280
BRA001	17	1,5	-	-	280
BRA001	56	1,5	-	-	280

## BRERA | h 70

colonna per lavabo

column for washbasin

CLASSIC COLORS					
BRC001	01; 00	18	16	27	380
BRC001	05; 00	18	16	27	590
BRC001	17; 00	18	16	27	590
MATT COLORS					
BRC001		18	16	27	590

# BRERA ACCESSORIES

piletta universale  
up & down cromo

ACA032		0,3	-	-	75
--------	--	-----	---	---	----

chrome up & down drain



piletta universale up & down  
con tappo in ceramica,  
con Saniglaze

CLASSIC COLORS					
ACA036	01; 34	0,3	-	-	80
ACA038	05; 34	0,3	-	-	90
ACA038	17; 34	0,3	-	-	90
MATT COLORS					
ACA038		34	0,3	-	90

up & down universal drain with  
ceramic cover for washbasins,  
with Saniglaze

piletta cromo con troppo pieno  
integrato  
chrome drain with integral  
overflow

ACA096		0,3	-	-	85
--------	--	-----	---	---	----



piletta con tappo in ceramica  
e troppo pieno integrato,  
con Saniglaze

CLASSIC COLORS					
ACA097	01; 34	0,3	-	-	90
ACA097	05; 34	0,3	-	-	90
ACA097	17; 34	0,3	-	-	90
MATT COLORS					
ACA097		34	0,3	-	90

drain with ceramic cover  
and integral overflow,  
with Saniglaze

tappo in ceramica  
per piletta filettata

CLASSIC COLORS					
ACA069	01; 00	0,3	-	-	29
ACA069	05; 00	0,3	-	-	29
ACA069	17; 00	0,3	-	-	29
MATT COLORS					
ACA069		0,3	-	-	29

ceramic cover  
for threaded drain

sifone cilindrico cromo  
chrome siphon

ACA022		1	-	-	130
--------	--	---	---	---	-----

sifone cilindrico - siphon

ACA099	05	1	-	-	180
ACA099	17	1	-	-	180

# FUORI SCALA

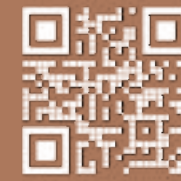

Scopri online  
Discover it online

Collezione di lavabi  
da appoggio e da incasso

Collection of countertop  
and drop in washbasins



# WASHBASINS COLLECTION

Tradition Inspiring the Future.  
A future perspective shaped by the past, innovation that respects origins and history. Fuori Scala is a new collection of basins with a versatile design that blends artistic expression and temporal planes, past, present and future, with essential and contemporary lines.

# Tradizione che ispira il futuro.

Guardare avanti con uno sguardo rivolto al passato, innovare rispettando le proprie radici e la propria storia. Fuori Scala è una collezione di lavabi dal design poliedrico, in grado di contaminare linguaggi e piani temporali, passato presente e futuro, dalle linee essenziali e contemporanee.

## **TFL032 | Ø 40**

Lavabo appoggio/incasso  
*Countertop/drop in washbasin*

## **TFL033 | 58 x 35**

Lavabo ovale appoggio/incasso  
*Oval countertop/drop in washbasin*



TFL032 | Ø 40

Lavabo appoggio/incasso  
Countertop/drop in washbasin



TFL033 | 58 x 35

Lavabo ovale appoggio/incasso  
Oval countertop/drop in washbasin



Fuori Scala basins are designed to bring character to the bathroom through a clean and immediately recognizable aesthetic. The ultra-thin rim enhances the lightness of the ceramic and the precision of its forms, creating an elegant profile that integrates naturally into any style, from the most minimalist to the most decorative. Versatile, refined, and contemporary, each basin becomes a standalone element that defines the architecture of the space, thanks to harmonious and well-balanced proportions.

I lavabi Fuori Scala sono pensati per dare carattere all'ambiente bagno attraverso un'estetica pulita e immediatamente riconoscibile. Il bordo ultra-sottile valorizza la leggerezza della ceramica e la sua precisione formale, creando un profilo elegante che si integra con naturalezza in qualsiasi stile, dal più minimale a quello più decorativo. Versatili, raffinati e contemporanei, ogni lavabo diventa un elemento autonomo che definisce l'architettura dello spazio grazie a proporzioni armoniose e ben equilibrate.

**TFL034 | 60 x 45**

Lavabo rettangolare  
appoggio/incasso  
*Rectangular countertop/drop  
in washbasin*



**TFL035 | 80 x 45**

Lavabo rettangolare  
appoggio/incasso  
*Rectangular countertop/drop  
in washbasin*

# FUORI SCALA SYSTEM

I lavabi Fuori Scala sono pensati per essere installati in due diversi modi: da appoggio, emulando nel segno quello di una grande pentola, e incassati nel top del mobile da bagno dove viene esaltato il suo caratteristico profilo a bordo fino, delineato da un bordo pronunciato e da una base di appoggio complanare.

*Fuori Scala washbasins are designed to be installed in two different ways, thanks to a very thin rim: they can be installed as ovetop basins - semiotically similar to a cooking pot - or as inset basins in line with the top of bathroom furniture where the evident thin rim is accentuated.*

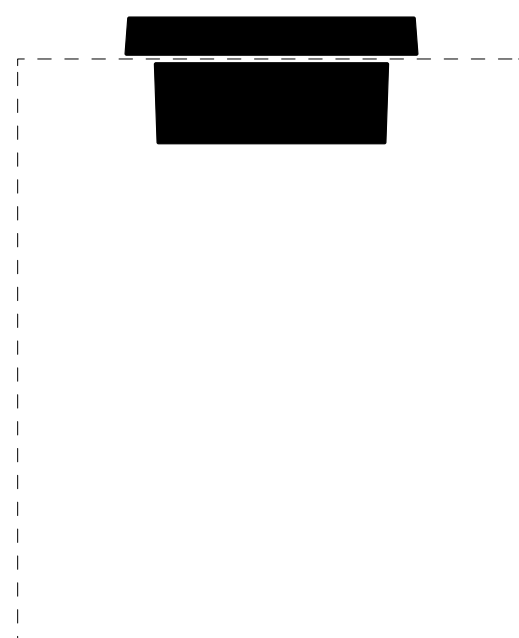

**lavabo incasso**  
*drop in washbasin*

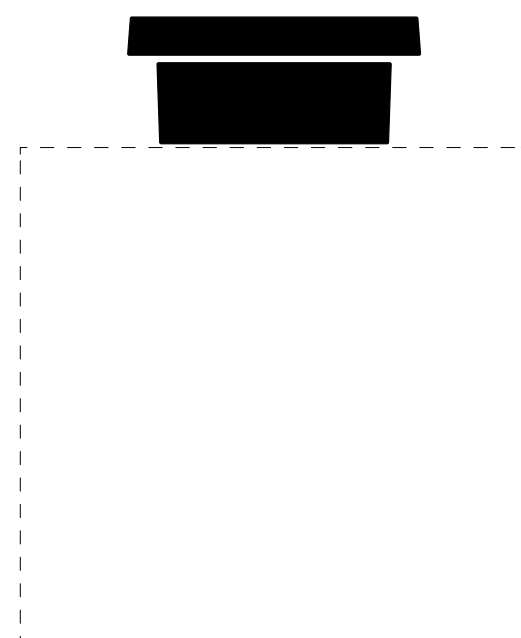

**lavabo appoggio**  
*countertop washbasin*



**TFL033 | 58 x 35**  
Lavabo ovale  
appoggio/incasso  
*Oval countertop/drop  
in washbasin*

**TFL032 | Ø 40**  
Lavabo appoggio/incasso  
*Countertop/drop in washbasin*



**TFL034 | 60 x 45**  
Lavabo rettangolare  
appoggio/incasso  
*Rectangular countertop/drop in  
washbasin*



**TFL035 | 80 x 45**  
Lavabo rettangolare  
appoggio/incasso  
*Rectangular countertop/drop in  
washbasin*

# FUORI SCALA OVERVIEW



## FUORI SCALA | Ø 40

lavabo appoggio/incasso

countertop/drop in washbasin



schede tecniche  
technical drawing

codice	colore	kg	pz. pallet Italia	pz. pallet Export	euro
TFL032	○ 01; 00	8	20	40	370



## FUORI SCALA | 58 x 35

lavabo ovale appoggio/incasso

oval countertop/drop in washbasin



schede tecniche  
technical drawing

codice	colore	kg	pz. pallet Italia	pz. pallet Export	euro
TFL033	○ 01; 00	9	20	40	395



## FUORI SCALA | 60 x 45

lavabo rettangolare appoggio/incasso

rectangular countertop/drop in washbasin



schede tecniche  
technical drawing

codice	colore	kg	pz. pallet Italia	pz. pallet Export	euro
TFL034	○ 01; 00	14	18	36	465



## FUORI SCALA | 80 x 45

lavabo rettangolare appoggio/incasso

rectangular countertop/drop in washbasin



schede tecniche  
technical drawing

codice	colore	kg	pz. pallet Italia	pz. pallet Export	euro
TFL035	○ 01; 00	20	16	32	495

# FUORI SCALA ACCESSORIES

piletta universale up & down cromo

chrome up & down drain

codice	colore	kg	pz. pallet Italia	pz. pallet Export	euro
ACA032		0,3	-	-	75

piletta universale up & down con tappo in ceramica, con Saniglaze

up & down universal drain with ceramic cover for washbasins, with Saniglaze



codice	colore	kg	pz. pallet Italia	pz. pallet Export	euro
ACA036	○ 01; 34	0,3	-	-	80

piletta cromo con troppo pieno integrato

chrome drain with integral overflow

codice	colore	kg	pz. pallet Italia	pz. pallet Export	euro
ACA096		0,3	-	-	85

piletta con tappo in ceramica e troppo pieno integrato, con Saniglaze

drain with ceramic cover and integral overflow, with Saniglaze



codice	colore	kg	pz. pallet Italia	pz. pallet Export	euro
ACA097	○ 01; 34	0,3	-	-	90

WASHBASINS

# ROMBO MILLE RIGHE



Scopri online  
Discover them online

Collezione di lavabi  
da appoggio 3D

3D countertop washbasins  
collection



# 3D WASHBASINS COLLECTION

Surfaces that take shape.  
Rombo interprets the countertop washbasin as a contemporary furnishing element, where the outer surface becomes a field for formal experimentation. The three-dimensional texture, inspired by matelassé textile quilting, wraps the volume like a soft and sophisticated covering, turning the basin into a decorative object that naturally dialogues with the surrounding space.

# Superfici che prendono forma.

Rombo interpreta il lavabo d'appoggio come un elemento d'arredo contemporaneo, in cui la superficie esterna diventa il luogo della sperimentazione formale. La texture tridimensionale, ispirata alle lavorazioni matelassé del mondo tessile, avvolge il volume come un rivestimento morbido e sofisticato, trasformando il lavabo in un oggetto decorativo capace di dialogare con lo spazio.



OSL009 | Ø 44

Lavabo appoggio  
Countertop washbasin



The interplay of light, shadow, relief and depth enhances the perception of the ceramic surface and defines a strong aesthetic identity - an expression of The.Artceram's care for detail, materiality and design culture.

WASHBASINS

Il gioco di pieni e vuoti, ombre e rilievi, dona profondità alla ceramica e definisce un'identità estetica riconoscibile, che coniuga eleganza, matericità e cura del dettaglio - valori distintivi del linguaggio The.Artceram.

Soft ceramic trompe-l'œil.  
Millerighe originates from the same design matrix as Rombo, further developing the research on 3D textures applied to the outer surface of the washbasin. In this case, the dialogue with the textile world is expressed through a more pronounced vertical padding - a sequence of rhythmic lines that emphasises the verticality of the volume and amplifies its scenic presence.

# Morbido trompe-l'œil ceramico.

Millerighe nasce dalla stessa matrice progettuale di Rombo, sviluppando la ricerca sulle texture 3D applicate alla superficie esterna del lavabo. In questo caso la contaminazione con il mondo tessile si traduce in una imbottitura verticale più marcata, una sequenza di righe ritmate che enfatizza la verticalità del volume e ne amplifica la presenza scenica.



OSL010 | Ø 44

Lavabo appoggio  
Countertop washbasin



The texture defines a bold and contemporary aesthetic language, where the washbasin becomes an expressive and identity-shaping object, conceived not only as a functional element but as an integral part of the interior design project. Millerighe enriches The.Artceram washbasin collection with a proposal of strong material and architectural character.

La texture definisce un linguaggio estetico deciso e contemporaneo, in cui il lavabo diventa un oggetto espressivo e identitario, pensato non solo come elemento funzionale ma come parte integrante del progetto d'interni. Millerighe arricchisce la famiglia dei lavabi The.Artceram con una proposta dal forte valore materico e architettonico.



WASHBASINS

# ROMBO & MILLERIGHE STYLES



## CLASSIC COLORS



bianco lucido / glossy white



bianco matt / matt white



nero matt / matt black

## MATT COLORS



grigio oliva / grey olive



blu avio / blue avio



marrone matera / brown matera



sabbia / sand



ghiaia / gravel

## GLOSSY COLORS



curcuma / turmeric



paprika / paprika



edera / ivy



zefiro / zephyr

# ROMBO & MILLERIGHE OVERVIEW



## ROMBO | Ø 44

lavabo appoggio

countertop washbasin



schede tecniche  
technical drawing

codice	colore	kg	pz. pallet Italia	pz. pallet Export	euro	
CLASSIC COLORS						
<b>OSL009</b>	○ 01; 00	9,5	20	40	370	
<b>OSL009</b>	◎ 05; 00	9,5	20	40	620	
<b>OSL009</b>	● 17; 00	9,5	20	40	620	
MATT COLORS						
<b>OSL009</b>		00	9,5	20	40	620
GLOSSY COLORS						
<b>OSL009</b>		00	9,5	20	40	620



## MILLERIGHE | Ø 44

lavabo appoggio

countertop washbasin



schede tecniche  
technical drawing

codice	colore	kg	pz. pallet Italia	pz. pallet Export	euro	
CLASSIC COLORS						
<b>OSL010</b>	○ 01; 00	9	20	40	370	
<b>OSL010</b>	◎ 05; 00	9	20	40	620	
<b>OSL010</b>	● 17; 00	9	20	40	620	
MATT COLORS						
<b>OSL010</b>		00	9	20	40	620
GLOSSY COLORS						
<b>OSL010</b>		00	9	20	40	620

# ROMBO & MILLERIGHE ACCESSORIES

piletta universale  
up & down cromo

chrome up & down drain



piletta universale up & down  
con tappo in ceramica,  
con Saniglaze

up & down universal drain with  
ceramic cover for washbasins,  
with Saniglaze

codice	colore	kg	pz. pallet Italia	pz. pallet Export	euro	
<b>ACA032</b>		0,3	-	-	75	
CLASSIC COLORS						
<b>ACA036</b>	○ 01; 34	0,3	-	-	80	
<b>ACA038</b>	◎ 05; 34	0,3	-	-	90	
<b>ACA038</b>	● 17; 34	0,3	-	-	90	
MATT COLORS						
<b>ACA038</b>		34	0,3	-	-	90
GLOSSY COLORS						
<b>ACA038</b>		34	0,3	-	-	90

piletta cromo con troppo pieno  
integrato

chrome drain with integral  
overflow



piletta con tappo in ceramica  
e troppo pieno integrato,  
con Saniglaze

drain with ceramic cover  
and integral overflow,  
with Saniglaze

codice	colore	kg	pz. pallet Italia	pz. pallet Export	euro	
<b>ACA096</b>		0,3	-	-	85	
CLASSIC COLORS						
<b>ACA097</b>	○ 01; 34	0,3	-	-	90	
<b>ACA097</b>	◎ 05; 34	0,3	-	-	90	
<b>ACA097</b>	● 17; 34	0,3	-	-	90	
MATT COLORS						
<b>ACA097</b>		34	0,3	-	-	90
GLOSSY COLORS						
<b>ACA097</b>		34	0,3	-	-	90

# ATE LIER



Scopri online  
Discover it online

Collezione  
di lavabi d'appoggio

Countertop  
washbasins collection



# WASHBASINS COLLECTION

Minimal-Retró: where eras meet.  
We live in a fascinating and complex world, full of contrasts and contradictions. We look ahead, yet remain deeply connected to our past; we embrace technology while treasuring the scents and flavors of memory. "Melting pot" and "vintage" perfectly describe the spirit of the Atelier collection.

# Minimal-Retró: l'incontro tra epoche.

Viviamo in un mondo straordinario, complesso, fatto di contrasti e contraddizioni. Guardiamo avanti ma restiamo legati al passato; abbracciamo l'innovazione tecnologica ma custodiamo gli odori e i sapori della memoria. "Melting pot" e "vintage" sono le parole chiave che meglio descrivono la collezione Atelier.

ATL002 | 60 x 40

Lavabo appoggio  
Countertop washbasin



**ATL002 | 60 x 40**

Lavabo appoggio  
Countertop washbasin

A true creative atelier where past and present meet, giving life to a minimal-retró collection: clean, linear shapes enhanced by a fine rim that contrasts and harmonizes with the rounded, iconic profile - a perfect balance between essential design and timeless memory.

Un vero e proprio laboratorio creativo dove presente e passato si incontrano per dare vita a una collezione minimal-retró: lineare nelle forme, impreziosita da un bordo sottile che dialoga con la rotondità e l'iconicità del suo profilo, in un perfetto equilibrio tra essenzialità e memoria.



**ATL001 | Ø 44**  
Lavabo appoggio  
*Countertop washbasin*



# ATELIER STYLES

## CLASSIC COLORS



cod. 01

bianco lucido / glossy white



cod. 05

bianco matt / matt white



cod. 17

nero matt / matt black

# ATELIER OVERVIEW

THE  
SANIGLAZE



## ATELIER | Ø 44

lavabo appoggio, con Saniglaze  
countertop washbasin,  
with Saniglaze



schede tecniche  
technical drawing

codice	colore	kg	pz. pallet Italia	pz. pallet Export	euro
CLASSIC COLORS					
ATL001	○ 01; 00	10	24	48	320
ATL001	◎ 05; 00	10	24	48	480
ATL001	● 17; 00	10	24	48	480

THE  
SANIGLAZE



## ATELIER | 60 x 40

lavabo appoggio, con Saniglaze  
countertop washbasin,  
with Saniglaze



schede tecniche  
technical drawing

codice	colore	kg	pz. pallet Italia	pz. pallet Export	euro
CLASSIC COLORS					
ATL002	○ 01; 00	12	20	40	345
ATL002	◎ 05; 00	12	20	40	520
ATL002	● 17; 00	12	20	40	520

# ATELIER ACCESSORIES

	codice	colore	kg	pz. pallet Italia	pz. pallet Export	euro
piletta universale up & down cromo	ACA032		0,3	-	-	75

chrome up & down drain

THE  
SANIGLAZE

piletta universale up & down  
con tappo in ceramica,  
con Saniglaze

up & down universal drain with  
ceramic cover for washbasins,  
with Saniglaze

CLASSIC COLORS

ACA036	○ 01; 34	0,3	-	-	80
ACA038	◎ 05; 34	0,3	-	-	90
ACA038	● 17; 34	0,3	-	-	90

piletta cromo con troppo pieno integrato	ACA096		0,3	-	-	85
---	--------	--	-----	---	---	----

chrome drain with integral  
overflow

THE  
SANIGLAZE

piletta con tappo in ceramica  
e troppo pieno integrato,  
con Saniglaze

drain with ceramic cover  
and integral overflow,  
with Saniglaze

CLASSIC COLORS

ACA097	○ 01; 34	0,3	-	-	90
ACA097	◎ 05; 34	0,3	-	-	90
ACA097	● 17; 34	0,3	-	-	90

# GHO ST



Scopri la online  
Discover it online



Collezione  
di lavabi d'appoggio

Countertop  
washbasins collection

# WASHBASINS COLLECTION

Lasting Lightness.

Ghost is a ceramic countertop washbasin with a clean, minimal design, available in two sizes. Its gently rounded shapes and ultra-thin rim give the product a sense of lightness and refined elegance.

# Leggerezza che resta.

Ghost è un lavabo da appoggio in ceramica dal design essenziale, caratterizzato da un bordo sottile ed esposto in due diverse misure. Le sue forme leggermente arrotondate e il profilo ceramico ridotto al minimo conferiscono al lavabo un'estetica leggera ed elegante.

GH001 | 42 x 42

Lavabo appoggio  
Countertop washbasin





**GHLO01 | 42 x 42**

Lavabo appoggio

Countertop washbasin



The collection features two thin-rim countertop washbasins designed to offer practical, versatile solutions for contemporary bathrooms. Both versions meet today's design requirements, combining functionality with a discreet yet sophisticated aesthetic.

WASHBASINS

La proposta comprende due lavabi da appoggio a bordo sottile, pensati per offrire soluzioni versatili e funzionali all'interno del bagno. Entrambe le versioni rispondono alle attuali esigenze progettuali, con un design che unisce praticità, stile e una presenza visiva discreta ma raffinata.

**GH002 | 65 x 42**  
Lavabo appoggio  
Countertop washbasin

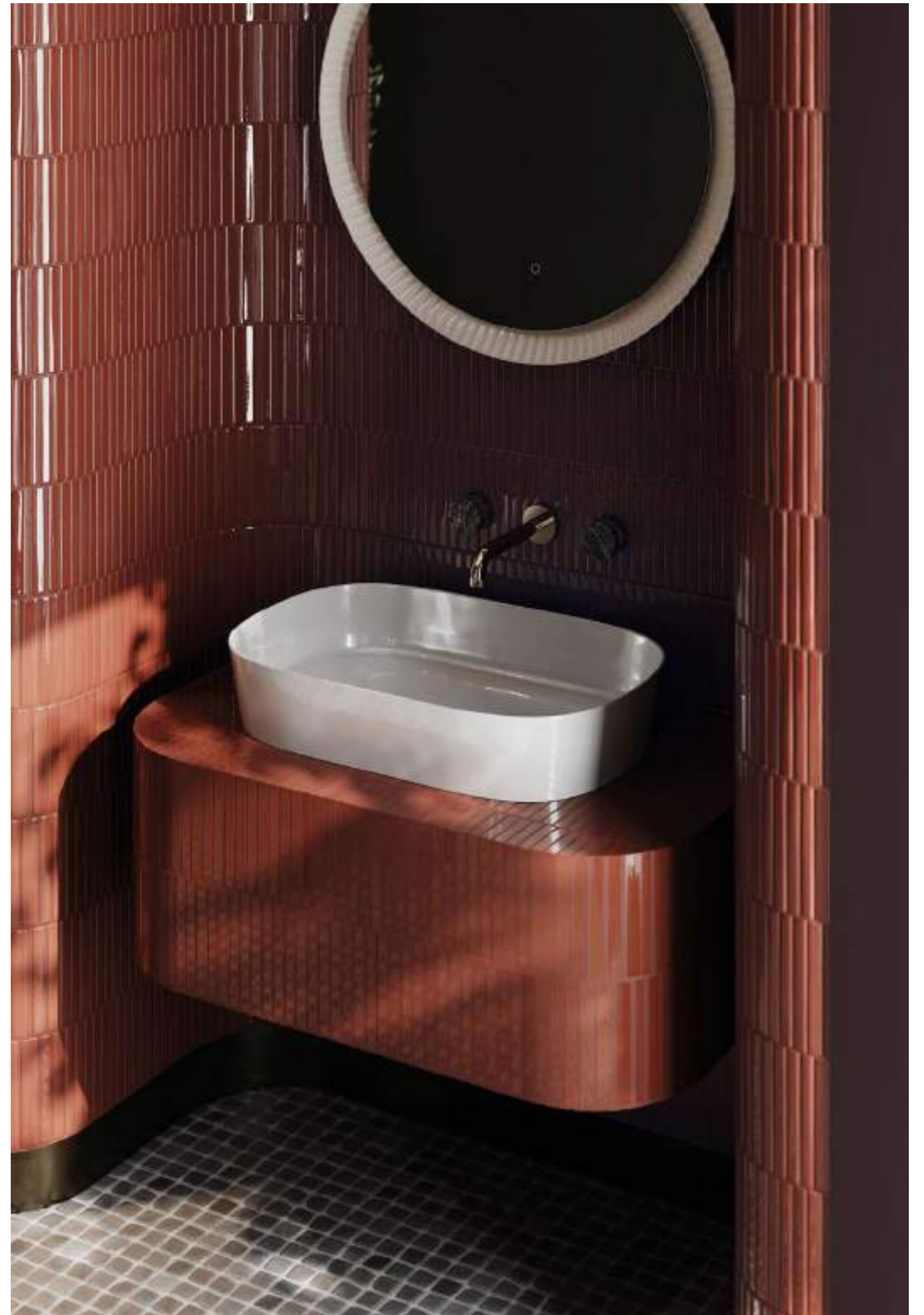

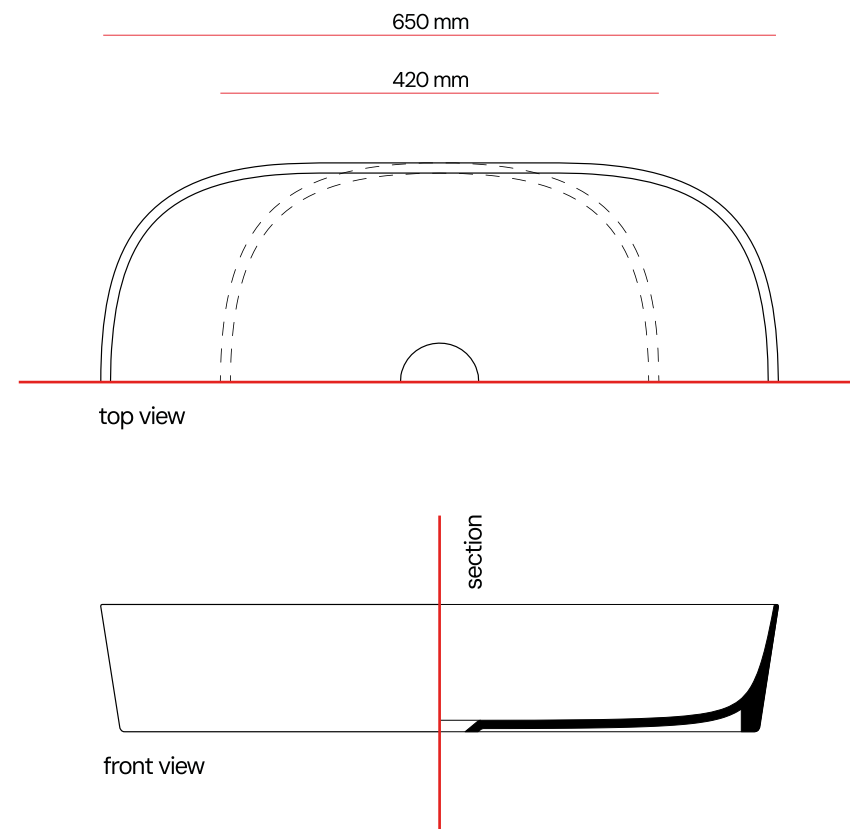

GH002 | 65 x 42  
 Lavabo appoggio  
 Countertop washbasin



## GHOST OVERVIEW

	codice	colore	kg	pz. pallet Italia	pz. pallet Export	euro
	<b>GH001</b>	01; 00	8	28	52	<b>340</b>
lavabo appoggio countertop washbasin		schede tecniche technical drawing				
	<b>GH002</b>	01; 00	11	20	40	<b>360</b>
lavabo appoggio countertop washbasin		schede tecniche technical drawing				

## GHOST ACCESSORIES

piletta universale up & down cromo	<b>ACA032</b>	0,3	-	-	<b>75</b>	
chrome up & down drain						
 piletta universale up & down con tappo in ceramica, con Saniglaze	<b>ACA036</b>	01; 34	0,3	-	-	<b>80</b>
up & down universal drain with ceramic cover for washbasins, with Saniglaze						
piletta cromo con troppo pieno integrato	<b>ACA096</b>	0,3	-	-	<b>85</b>	
chrome drain with integral overflow						
 piletta con tappo in ceramica e troppo pieno integrato, con Saniglaze	<b>ACA097</b>	01; 34	0,3	-	-	<b>90</b>
drain with ceramic cover and integral overflow, with Saniglaze						

# LA CIO TOLOLA



Scopri online  
Discover it online

Collezione  
di lavabi d'appoggio

Countertop  
washbasins collection



# WASHBASINS COLLECTION

Essential form of the everyday.  
La Ciotola is born from the simplest and most authentic idea of a washbasin: a welcoming container designed for everyday use, where form and function naturally coincide. Its rounded, continuous geometry recalls the instinctive gesture of collected water, transforming a primary object into a contemporary design element.

# Forma essenziale del quotidiano.

La Ciotola nasce dall'idea più semplice e autentica del lavabo: un contenitore accogliente, pensato per l'uso quotidiano, dove forma e funzione coincidono. La geometria tonda e continua richiama il gesto naturale dell'acqua raccolta, trasformando un oggetto primario in un elemento di design contemporaneo.

LCL001 | Ø 46

Lavabo appoggio  
Countertop washbasin





**LCLO01 | Ø 46**

Lavabo appoggio  
Countertop washbasin

Available in two sizes, La Ciotola adapts to different design requirements while maintaining a balanced, essential and refined aesthetic. The spacious, generous basin ensures comfort and practicality, while the thin rim lightens its visual presence and enhances the purity of the ceramic.

Disponibile in due dimensioni, La Ciotola si adatta a diverse esigenze progettuali, mantenendo sempre un'estetica equilibrata, essenziale e raffinata. La vasca ampia e generosa garantisce comfort e praticità, mentre il bordo sottile alleggerisce la presenza visiva e valorizza la purezza della ceramica.

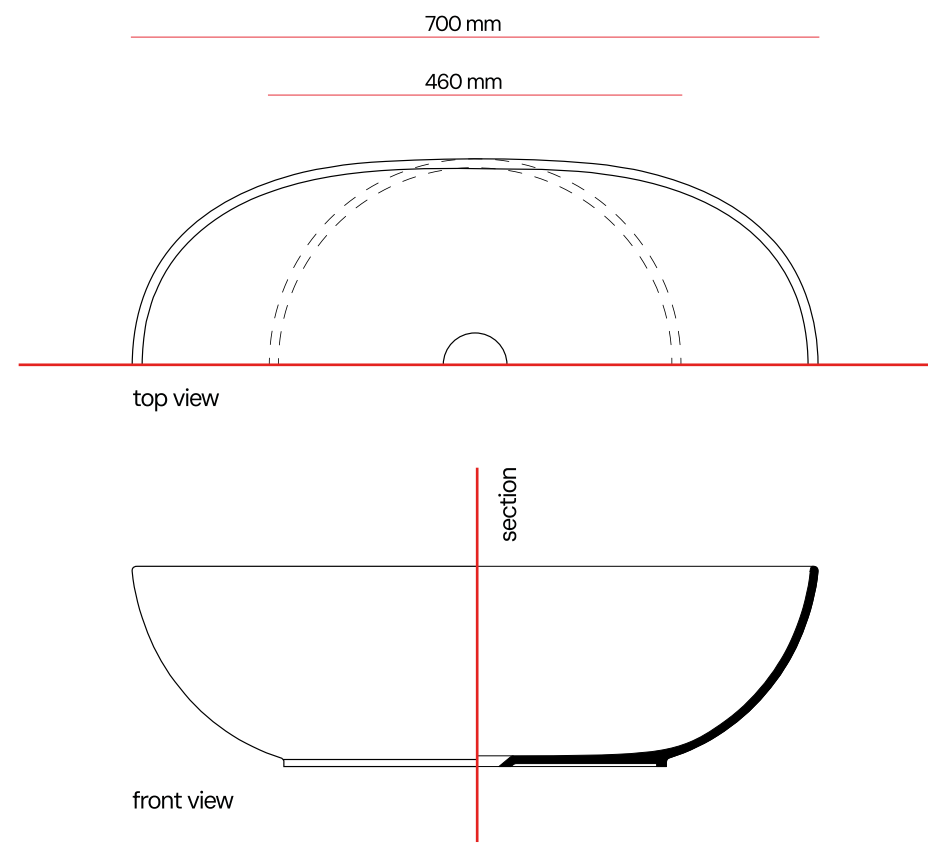

**LCL002 | 70 x 44**  
 Lavabo appoggio  
 Countertop washbasin

# LA CIOTOLA OVERVIEW



## LA CIOTOLA 46 | Ø 46

codice	colore	kg	pz. pallet Italia	pz. pallet Export	euro
LCL001	○ 01; 00	9	16	28	380

lavabo appoggio

countertop washbasin



schede tecniche  
technical drawing



## LA CIOTOLA 70 | 70 x 44

codice	colore	kg	pz. pallet Italia	pz. pallet Export	euro
LCL002	○ 01; 00	14	16	28	415

lavabo appoggio

countertop washbasin



schede tecniche  
technical drawing

# LA CIOTOLA ACCESSORIES

	codice	colore	kg	pz. pallet Italia	pz. pallet Export	euro
piletta universale up & down cromo	ACA032		0,3	-	-	75

chrome up & down drain



piletta universale up & down con tappo in ceramica, con Saniglaze

ACA036	○ 01; 34	0,3	-	-	80
--------	----------	-----	---	---	----

up & down universal drain with ceramic cover for washbasins, with Saniglaze

piletta cromo con troppo pieno integrato	ACA096		0,3	-	-	85
--	--------	--	-----	---	---	----

chrome drain with integral overflow



piletta con tappo in ceramica e troppo pieno integrato, con Saniglaze

ACA097	○ 01; 34	0,3	-	-	90
--------	----------	-----	---	---	----

drain with ceramic cover and integral overflow, with Saniglaze

# LAVA MANI



Scopri online  
Discover them online

Collezione di lavabi sospesi  
di dimensioni ridotte

Small wall-hung washbasins  
collection



## SMALL WASHBASINS COLLECTION

## Small Balances.

A collection of small wall-hung washbasins to use when the bathroom area is reduced in size but the end-users do not want to leave nothing chance! Compact shapes softened by round angles and slim rims characterize these minimal morphological units useful to create perfect combinations according to space and design intuitions.

# Piccoli equilibri.

Una serie di lavabi di piccole dimensioni da posizionare a parete quando le dimensioni della stanza da bagno sono ridotte ma non si vuole lasciare nulla al caso! Le forme compatte, ingentilite da angoli arrotondati e spessori particolarmente sottili, definiscono questi oggetti come unità morfologiche minime, con cui comporre liberamente configurazioni sempre adeguate agli spazi disponibili e alle intuizioni progettuali.



LML001 UNION | 27 x 43  
Lavamani sospeso  
Wall-hung handrinse basin

**LML002 BRICK | 20 x 54**  
Lavamani sospeso  
Wall-hung handrinse basin



**LML003 SAVON | 27 x 45**  
Lavamani sospeso  
Wall-hung handrinse basin



A versatile proposal, contemporary in terms of design that can be properly inserted in various architectural settings matching or not other elements of collections made in Artceram!

WASHBASINS

Una proposta versatile, dal design contemporaneo, che si presta ad un inserimento sempre appropriato nei più diversi contesti architettonici, anche in abbinamento con altri elementi delle collezioni Artceram!

**SCL005 | 38 x 27**

Lavabo sospeso/appoggio  
Wall-hung/countertop washbasin



A destra / On the right:

**SCL006 | 50 x 27**

Lavabo sospeso/appoggio  
Wall-hung/countertop washbasin





**ROL004 | 40 x 38**

Lavabo sospeso/appoggio  
Wall-hung/countertop washbasin



# LAVAMANI OVERVIEW



**UNION | 27 x 43**

lavamani sospeso  
wall-hung handrinse basin

codice	colore	kg	pz. pallet Italia	pz. pallet Export	euro	
LML001	○	01; 00	7	50	100	280



schede tecniche  
technical drawing

\* tasselli per fissaggio lavabi sospesi, non inclusi con il lavabo

ACA007	0,3	-	-	15
--------	-----	---	---	----

fitting system kit for wall-hung washbasins, not included with the washbasin



**BRICK | 20 x 54**

lavamani sospeso  
wall-hung handrinse basin

codice	colore	kg	pz. pallet Italia	pz. pallet Export	euro	
LML002	○	01; 00	7	50	100	280



schede tecniche  
technical drawing

\* tasselli per fissaggio lavabi sospesi, non inclusi con il lavabo

ACA007	0,3	-	-	15
--------	-----	---	---	----

fitting system kit for wall-hung washbasins, not included with the washbasin



**SAVON | 27 x 45**

lavamani sospeso  
wall-hung handrinse basin

codice	colore	kg	pz. pallet Italia	pz. pallet Export	euro	
LML003	○	01; 00	7	50	100	280



schede tecniche  
technical drawing

\* tasselli per fissaggio lavabi sospesi, non inclusi con il lavabo

ACA007	0,3	-	-	15
--------	-----	---	---	----

fitting system kit for wall-hung washbasins, not included with the washbasin

# LAVAMANI OVERVIEW



	codice	colore	kg	pz. pallet Italia	pz. pallet Export	euro
<b>SCALINO 38   38 x 27</b>	<b>SCL005</b>	○ 01; 00	8	50	108	225

lavabo sospeso/appoggio  
wall-hung/countertop washbasin



schede tecniche  
technical drawing

\* tasselli per fissaggio lavabi sospesi, non inclusi con il lavabo

<b>ACA007</b>	0,3	-	-	15
---------------	-----	---	---	----

fitting system kit for wall-hung washbasins, not included with the washbasin



<b>SCALINO 50   50 x 27</b>	<b>SCL006</b>	○ 01; 00	11	33	66	265
-----------------------------	---------------	----------	----	----	----	-----

lavabo sospeso/appoggio  
wall-hung/countertop washbasin



schede tecniche  
technical drawing

\* tasselli per fissaggio lavabi sospesi, non inclusi con il lavabo

<b>ACA007</b>	0,3	-	-	15
---------------	-----	---	---	----

fitting system kit for wall-hung washbasins, not included with the washbasin



THE SANIGLAZE

<b>RODOLFO 40   40 x 38</b>	<b>ROL004</b>	○ 01; 34	12	28	52	300
-----------------------------	---------------	----------	----	----	----	-----

lavabo sospeso/appoggio  
1 foro, con Saniglaze

wall-hung/countertop washbasin 1 hole, with Saniglaze



schede tecniche  
technical drawing

\* tasselli per fissaggio lavabi sospesi, non inclusi con il lavabo

<b>ACA007</b>	0,3	-	-	15
---------------	-----	---	---	----

fitting system kit for wall-hung washbasins, not included with the washbasin

# LAVAMANI ACCESSORIES

	codice	colore	kg	pz. pallet Italia	pz. pallet Export	euro
piletta universale up & down cromo	<b>ACA032</b>		0,3	-	-	75

chrome up & down drain



piletta universale up & down con tappo in ceramica, con Saniglaze	<b>ACA036</b>	○ 01; 34	0,3	-	-	80
---	---------------	----------	-----	---	---	----

up & down universal drain with ceramic cover for washbasins, with Saniglaze

piletta cromo con troppo pieno integrato	<b>ACA096</b>		0,3	-	-	85
--	---------------	--	-----	---	---	----

chrome drain with integral overflow



piletta con tappo in ceramica e troppo pieno integrato, con Saniglaze	<b>ACA097</b>	○ 01; 34	0,3	-	-	90
---	---------------	----------	-----	---	---	----

drain with ceramic cover and integral overflow, with Saniglaze

sifone cilindrico cromo	<b>ACA022</b>		1	-	-	130
-------------------------	---------------	--	---	---	---	-----

chrome siphon

# SOTTO PIANO



Scoprili online  
Discover them online

Collezione di lavabi sottopiano

Under-countertop washbasins  
collection

DIANA  
IDEA  
NETTUNO  
GEA

# LAVABI SOTTOPIANO OVERVIEW



**DIANA | 57 x 40**

lavabo sottopiano  
under-counter washbasin

codice	colore	kg	pz. pallet Italia	pz. pallet Export	euro
DIL001	○ 01; 00	7	20	36	180



schede tecniche  
technical drawing

\* tasselli per fissaggio lavabi sottopiano, non inclusi con il lavabo

ACA001	0,3	-	-	12
--------	-----	---	---	----

fitting system kit for under-counter washbasins, not included with the washbasin



**IDEA | 60 x 37**

lavabo sottopiano  
under-counter washbasin

codice	colore	kg	pz. pallet Italia	pz. pallet Export	euro
IDL001	○ 01; 00	8	20	36	180



schede tecniche  
technical drawing

\* tasselli per fissaggio lavabi sottopiano, non inclusi con il lavabo

ACA001	0,3	-	-	12
--------	-----	---	---	----

fitting system kit for under-counter washbasins, not included with the washbasin



**NETTUNO | 56 x 38**

lavabo sottopiano  
under-counter washbasin

codice	colore	kg	pz. pallet Italia	pz. pallet Export	euro
NTL001	○ 01; 00	8	20	36	195



schede tecniche  
technical drawing

\* tasselli per fissaggio lavabi sottopiano, non inclusi con il lavabo

ACA001	0,3	-	-	12
--------	-----	---	---	----

fitting system kit for under-counter washbasins, not included with the washbasin

# LAVABI SOTTOPIANO OVERVIEW



**GEA | 53 x 34,5**

lavabo sottopiano  
under-counter washbasin

codice	colore	kg	pz. pallet Italia	pz. pallet Export	euro
GEL001	○ 01; 00	8	20	36	195



schede tecniche  
technical drawing

\* tasselli per fissaggio lavabi sottopiano, non inclusi con il lavabo

ACA001	0,3	-	-	12
--------	-----	---	---	----

fitting system kit for under-counter washbasins, not included with the washbasin



**GEA 90 | 90 x 33**

lavabo sottopiano  
under-counter washbasin

codice	colore	kg	pz. pallet Italia	pz. pallet Export	euro
GEL002	○ 01; 00	15	12	26	260



schede tecniche  
technical drawing

\* tasselli per fissaggio lavabi sottopiano, non inclusi con il lavabo

ACA001	0,3	-	-	12
--------	-----	---	---	----

fitting system kit for under-counter washbasins, not included with the washbasin

# LAVABI SOTTOPIANO ACCESSORIES

piletta universale up & down cromo  
chrome up & down drain

ACA032	0,3	-	-	75
--------	-----	---	---	----

piletta universale up & down con tappo in ceramica, con Saniglaze

ACA036	○ 01; 34	0,3	-	-	80
--------	----------	-----	---	---	----

up & down universal drain with ceramic cover for washbasins, with Saniglaze



# MIR RORS

SPECCHI  
THE.ARTCERAM

LORD (P.612)  
MILANO (P.622)  
LOOK (P.632)  
ARCHI (P.640)

# LORD



Scopri online  
Discover it online

Specchio tondo in ceramica  
con retroilluminazione LED  
ed accensione touch

Round retro led mirror  
with ceramic frame  
and touch switch



## CERAMIC MIRROR

Reflections of the Belle Époque.

Lord is a back-lit ceramic decorative mirror. With Lord, we focused on the decorative aspect of ceramic craftsmanship, drawing inspiration from the typical details of Belle Époque tableware. The mirror is deliberately designed in a single round version, just like traditional plates.

# Riflessi della Belle Époque.

Lord è uno specchio decorativo in ceramica, retroilluminato. Con Lord abbiamo lavorato sulla decorazione della ceramica, ricercando dettagli tipici delle lavorazioni artigianali dei piatti da portata della Belle Époque. Lo specchio è intenzionalmente proposto solo in versione rotonda, proprio come i tradizionali piatti da portata.

ACS018 | Ø 76

Specchio tondo in ceramica  
con retroilluminazione LED  
ed accensione touch  
*Round retro led mirror  
with ceramic frame and touch  
switch*





**ACS018 | Ø 76**

Specchio tondo in ceramica  
con retroilluminazione LED  
ed accensione touch  
*Round retro led mirror  
with ceramic frame and touch  
switch*

This "trait d'union" has created a light wavy décor that starts from the centre of the mirror and expands to its fullest expression at the edge of the circle. The transition becomes even more refined when the back light is on, enhancing the waves with a fascinating play of light and shadow.

Questo trait d'union ha dato vita a un leggerissimo decoro a onde che parte dal centro dello specchio per amplificarsi fino a esprimersi pienamente lungo il cerchio. Una transizione resa ancora più preziosa all'accensione della retroilluminazione, che valorizza le onde generando un suggestivo gioco di luci e ombre.



**ACS018 | Ø 76**

Specchio tondo in ceramica  
con retroilluminazione LED  
ed accensione touch  
*Round retro led mirror  
with ceramic frame and touch switch*

**ACS018 | Ø 76**

Specchio tondo in ceramica  
con retroilluminazione LED  
ed accensione touch  
*Round retro led mirror  
with ceramic frame  
and touch switch  
nero matt / matt black*



# LORD STYLES

## CLASSIC COLORS



bianco lucido / glossy white



bianco matt / matt white



nero matt / matt black

## MATT COLORS



grigio oliva / grey olive



blu avio / blue avio



marrone matera / brown matera



sabbia / sand



ghiaia / gravel

## GLOSSY COLORS



curcuma / turmeric



paprika / paprika



edera / ivy



zefiro / zephyr

# LORD OVERVIEW



## LORD | Ø 76

specchio tondo in ceramica  
con retroilluminazione LED  
ed accensione touch

round retro led mirror  
with ceramic frame and touch  
switch



schede tecniche  
technical drawing

codice	colore	kg	pz. pallet Italia	pz. pallet Export	euro
CLASSIC COLORS					
ACS018	○ 01; 00	13	-	-	1050
ACS018	◎ 05; 00	13	-	-	1700
ACS018	● 17; 00	13	-	-	1700
MATT COLORS					
ACS018		13	-	-	1700
GLOSSY COLORS					
ACS018		13	-	-	1700

# MILANO



Scopri online  
Discover it online

Specchio con cornice  
in ceramica, retroilluminazione  
LED ed accensione touch

Retro LED mirror with ceramic  
frame and touch switch



## CERAMIC MIRROR

A mirror that plays with shapes.  
Milano mirror is our designers' tribute to their adopted city. A decorative, back-lit ceramic mirror that merges the dynamism of soft, enveloping shapes with the solidity of ceramic, creating a playful yet strong character.

# Lo specchio che gioca con la forma.

Lo specchio Milano è un omaggio dei nostri designer alla loro città d'adozione. È uno specchio decorativo in ceramica, retroilluminato, che unisce la dinamicità delle forme morbide e avvolgenti alla solidità della ceramica, dando vita a un elemento giocoso ma dal carattere deciso.



**ACS019 | 55 x 100**

Specchio con cornice  
in ceramica, retroilluminazione  
LED ed accensione touch  
*Retro LED mirror with ceramic  
frame and touch switch*

Its defined aesthetics recall Jeff Koons' "Inflatable Art," with a rim that appears hollow and inflated, as if it had been shaped by air. This detail makes the mirror intriguing and unexpected, turning it into more than a reflective surface – a true statement piece with artistic value.

Un'estetica definita richiama la "Inflatable Art" di Jeff Koons, con un bordo che sembra cavo e gonfiato, quasi modellato dall'aria. Questo dettaglio sorprende e incuriosisce, trasformando lo specchio in un elemento che non si limita a riflettere, ma che diventa anche un oggetto artistico e di conversazione.



**ACS019 | 55 x 100**  
 Specchio con cornice  
 in ceramica, retroilluminazione  
 LED ed accensione touch  
*Retro LED mirror with ceramic  
 frame and touch switch  
 edera / ivy*

A sinistra / On the left:

**ACS019 | 55 x 100**  
 Specchio con cornice  
 in ceramica, retroilluminazione  
 LED ed accensione touch  
*Retro LED mirror with ceramic  
 frame and touch switch*

# MILANO STYLES

## CLASSIC COLORS



bianco lucido / *glossy white*



bianco matt / *matt white*



nero matt / *matt black*

## MATT COLORS



grigio oliva / *grey olive*



blu avio / *blue avio*



marrone matera / *brown matera*



sabbia / *sand*



ghiaia / *gravel*

## GLOSSY COLORS



curcuma / *turmeric*



paprika / *paprika*



edera / *ivy*



zefiro / *zephyr*

# MILANO OVERVIEW



## MILANO | 55 x 100

specchio con cornice in ceramica,  
retroilluminazione LED ed  
accensione touch

*retro LED mirror with ceramic frame  
and touch switch*



schede tecniche  
*technical drawing*

codice	colore	kg	pz. pallet Italia	pz. pallet Export	euro
CLASSIC COLORS					
ACS019	○ 01	13	-	-	900
ACS019	◎ 05	13	-	-	1370
ACS019	● 17	13	-	-	1370
MATT COLORS					
ACS019		13	-	-	1370
GLOSSY COLORS					
ACS019		13	-	-	1370

# LOOK



Scopri online  
Discover it online

Collezione di specchi  
con cornice metallica  
e retroilluminazione LED

Collection of retro LED mirrors  
with metal frame



# METAL FRAME MIRRORS COLLECTION

Silent focal point.

Look, literally “to look”, is a collection of mirrors that capture attention without ever raising their voice - pieces that settle gracefully into the space, bringing balance, light, and depth. Essential yet never ordinary, Look becomes the focal point of the room: a discreet presence that reflects not only the image, but also the atmosphere of the place it inhabits. The jutting metal frame - available in different finishes - outlines a contemporary profile with a measured character.

# Punto focale silenzioso.

Look, letteralmente tradotto dall'inglese “guardare”, è una collezione di specchi che catturano l'attenzione senza mai alzare la voce, capaci di inserirsi con eleganza nello spazio e di restituire equilibrio, luce e profondità. Elemento essenziale ma mai banale, Look diventa così il punto focale della stanza: una presenza discreta che riflette non solo l'immagine, ma anche l'atmosfera del luogo in cui vive. La cornice metallica a sporgere, disponibile in diverse finiture, definisce un profilo contemporaneo e dal carattere misurato.

ACS016 | Ø 85

Specchio con cornice metallica,  
con retroilluminazione LED  
ed accensione touch

Retro LED mirror with metal  
frame and touch switch  
bianco matt / matt white



**ACS017 | 50 x 90**

Specchio con cornice metallica,  
installazione verticale  
od orizzontale  
*Mirror with metal frame, vertical  
or horizontal installation  
nero matt / matt black*



**ACS016 | Ø 85**

Specchio con cornice metallica,  
con retroilluminazione LED  
ed accensione touch  
*Retro LED mirror with metal  
frame and touch switch  
nero matt / matt black*



The collection unfolds in two variations: a round version, and a softer, elongated “biscuit-shaped” silhouette, both designed to integrate naturally into any interior style. The round model is also available with LED backlighting and touch activation, a solution that enhances the luminous effect and gently highlights the entire surface. Look is the mirror that guides the gaze and transforms everyday functionality into a gesture of pure aesthetics.

La collezione si articola in due varianti: una versione rotonda e una dalla silhouette a “biscotto” più morbida e allungata, entrambe pensate per integrarsi con naturalezza in qualsiasi stile. Il modello tondo è disponibile anche con retroilluminazione LED e accensione touch, una soluzione che amplifica l'effetto luminoso e valorizza con delicatezza l'intera superficie. Look è lo specchio che accompagna lo sguardo e trasforma la funzionalità quotidiana in un gesto di pura estetica.

### ACS016 | Ø 85

Specchio con cornice metallica,  
con retroilluminazione LED  
ed accensione touch  
*Retro LED mirror with metal  
frame and touch switch*  
nero matt / matt black



## LOOK STYLES

### METALS



bianco matt / *matt white*  
RAL 9016



nero matt / *matt black*  
RAL 9005



moka / *moka*  
RAL 8014

## LOOK OVERVIEW



### LOOK RING | Ø 85

specchio con cornice metallica  
a sporgere, con retroilluminazione  
LED ed accensione touch

*retro LED mirror with jutting metal  
frame and touch switch*



schede tecniche  
*technical drawing*



### LOOK ARCO | 50 x 90

specchio con cornice metallica  
a sporgere, installazione verticale od  
orizzontale

*mirror with jutting metal frame,  
vertical or horizontal installation*



schede tecniche  
*technical drawing*

codice	colore	kg	pz. pallet Italia	pz. pallet Export	euro
METALS					
<b>ACS016</b>		9	-	-	1200

METALS					
<b>ACS017</b>		8	-	-	470

# ARCHI



Scopri la online  
Discover it online

Collezione di specchi  
con retroilluminazione LED  
e accensione touch

Collection of retro LED mirrors  
with touch switch



# MIRRORS COLLECTION

Minimal reflections.

A key bathroom element, Archi mirrors express functionality through a rigorous, contemporary approach.

Stripped of the superfluous, they highlight a large frameless reflective surface as the visual focus of the space.

Conceived as architectural elements, they enhance light and depth while engaging naturally with their surroundings. Integrated LED backlighting and touch activation ensure an intuitive, discreet user experience.

# Riflessi minimali.

Accessorio centrale della stanza da bagno, gli specchi Archi interpretano la funzionalità in chiave rigorosa e contemporanea. Eliminano il superfluo per valorizzare l'ampia superficie specchiante a vivo, fulcro visivo dello spazio. Concepiti come elementi architettonici, amplificano luce e profondità dialogando con l'ambiente in modo naturale. Retroilluminazione LED integrata e accensione touch garantiscono un utilizzo intuitivo e discreto.

**ACS014 | 50 x 120**

Specchio con retroilluminazione a led ed accensione touch, installazione verticale od orizzontale

*Retro LED mirror with touch switch, vertical or horizontal installation*





### ACS013 | 50 x 90

Specchio con retroilluminazione a led ed accensione touch, installazione solo verticale  
*Retro LED mirror with touch switch, only vertical installation*

### ACS012 | 50 x 90

Specchio con retroilluminazione a led ed accensione touch, installazione verticale od orizzontale  
*Retro LED mirror with touch switch, vertical or horizontal installation*

## ARCHI OVERVIEW



	codice	colore	kg	pz. pallet Italia	pz. pallet Export	euro
<b>ARCO 90   50 x 90</b>	<b>ACS012</b>		5	-	-	<b>470</b>

specchio con retroilluminazione a led ed accensione touch, installazione verticale od orizzontale

*retro LED mirror with touch switch, vertical or horizontal installation*



schede tecniche  
*technical drawing*

<b>SEMIARCO 90   50 x 90</b>	<b>ACS013</b>		5	-	-	<b>470</b>
------------------------------	---------------	--	---	---	---	------------

specchio con retroilluminazione a led ed accensione touch, installazione solo verticale

*retro LED mirror with touch switch, only vertical installation*



schede tecniche  
*technical drawing*

<b>ARCO 120   50 x 120</b>	<b>ACS014</b>		7	-	-	<b>600</b>
----------------------------	---------------	--	---	---	---	------------

specchio con retroilluminazione a led ed accensione touch, installazione verticale od orizzontale

*retro LED mirror with touch switch, vertical or horizontal installation*



schede tecniche  
*technical drawing*

# ACCES SORIES

ACCESSORI  
THE.ARTCERAM

PASSEPARTOUT (P.648)  
BOLD (P.660)

# PASSE PAR TOUT



Scopri la online  
Discover it online

Collezione di accessori bagno,  
mensole in ceramica

Collection of bathroom  
accessories, ceramic shelves



## CERAMIC SHELF

The solution for freestanding basins.  
Transversality and dynamism define the Passepartout shelf for basins, which reinterprets space with intelligence and cunning. This practical shelf meets various needs, facilitating a “free” design of the bathroom environment, allowing easy insertion and hydraulic management of freestanding basins even in spaces previously prohibitive in terms of water inlet, outlet and dedicated fixture installation.

# La soluzione per i lavabi centrostanza.

Trasversalità e dinamismo definiscono la mensola per lavabi Passepartout, che reinterpreta lo spazio con intelligenza e astuzia. Questa pratica mensola risponde a diverse esigenze facilitando una progettazione “libera” dell’ambiente bagno permettendo un facile inserimento e gestione idraulica dei lavabi centrostanza anche in quegli ambienti che sino ad oggi erano proibitivi da un punto di vista di gestione del carico, scarico e inserimento della rubinetteria dedicata.

## OSLO14 | 52 x 23

Mensola di ceramica con foro rubinetteria e scarico acqua per collegamento sifone a sinistra  
*Ceramic shelf with tap holes and water drain for siphon connection on the left*



**OSL017 | 52 x 23**

Mensola di ceramica  
con foro rubinetteria  
a sinistra  
*Ceramic shelf  
with left faucet hole*



**OSL014 | 52 x 23**

Mensola di ceramica con foro  
rubinetteria e scarico acqua per  
collegamento sifone a sinistra  
*Ceramic shelf with tap holes  
and water drain for siphon  
connection on the the left*

As the name "Passepartout" suggests (literally "goes everywhere"), it's an analogy: a key that opens multiple locks, a system for solving any problem. Passepartout is designed to be paired with an infinite variety of pedestal basins, thus simulating the effect of freestanding basins kept slightly away from the wall. It offers an elegant solution to hide standard drains, it optimizes space, and maintains the order and visual cleanliness of the bathroom.

Come suggerisce il nome «pas partù» ( propr. «passa dappertutto») è un'analogia: una chiave che serve ad aprire più serrature, un sistema per risolvere qualsiasi problema. Passepartout è concepita per essere affiancata a un'infinita varietà di lavabi a colonna, simulando così l'effetto dei lavabi "centrostanza" tenuti leggermente scostati dal muro. Offre una soluzione elegante per nascondere gli scarichi standard, ottimizza gli spazi mantenendo l'ordine e la pulizia visiva del bagno.



## PASSEPARTOUT SYSTEM

La mensola Passepartout offre una soluzione elegante per nascondere gli scarichi standard e, grazie al suo design intelligente, consente di posizionare la rubinetteria in modo pratico e senza necessità di interventi murari. Passepartout può essere accostata ai nostri lavabi a colonna Jolie e Brera; ma può anche essere abbinata a centrostanza di altri brand (consigliamo però di verificarne le caratteristiche tecniche).

*The Passepartout shelf offers an elegant solution to conceal standard drains and, thanks to its smart design, allows for the practical placement of the faucets without the need for masonry work.*

*Passepartout can be mounted with our Jolie and Brera column washbasins; but it can also be matched with freestanding washbasins from other brands (however, we recommend checking their technical specifications).*

con rubinetto installato a 35°  
(no foro scarico sulla ceramica)  
*with faucet installed at 35°  
(no drain hole on the ceramic)*

c/n rubinetto dietro centrale  
(foro scarico sulla ceramica)  
*with faucet at the central back  
(no drain hole on the ceramic)*

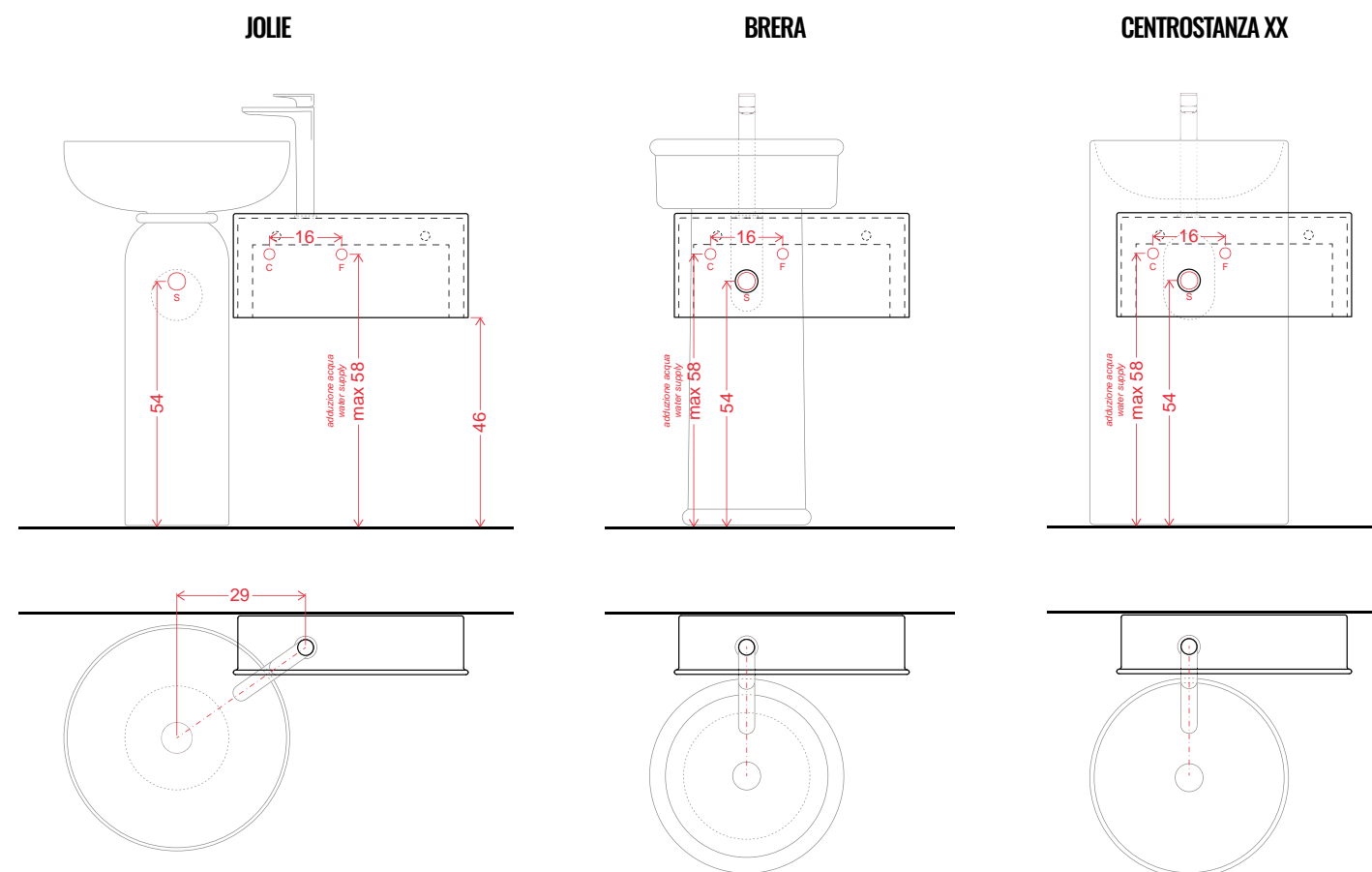

### OSL014 | 52 x 23

Mensola di ceramica con foro rubinetteria e scarico acqua per collegamento sifone a sinistra

*Ceramic shelf with tap holes and water drain for siphon connection on the the left*

# PASSEPARTOUT PLACEMENT

La versatilità di Passepartout le consente di adattarsi perfettamente ai lavabi Jolie e Brera, ed è installabile sia a destra che a sinistra. Al momento dell'ordine, verificare quale schema di fori sulla ceramica sia necessario per l'installazione dei pezzi!

*The versatility of Passepartout allows it to perfectly fit the Jolie and Brera column washbasins, and it can be installed both on the right and left sides. At the time of ordering, please check which hole pattern on the ceramic is needed for the installation of the pieces!*

## SCHEMA 1 (OSL014)

Fori rubinetteria e scarico acqua per collegamento sifone a sinistra  
(installazione alla DX del lavabo)  
*Tap holes and water drain for siphon connection on the left*  
(installation to the right of the sink)

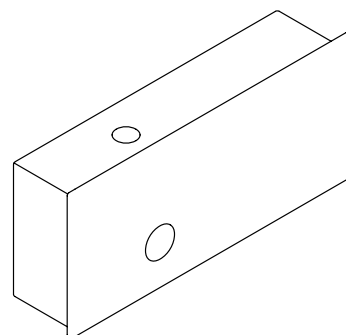

## SCHEMA 2 (OSL015)

Fori rubinetteria e scarico acqua per collegamento sifone a destra  
(installazione alla SX del lavabo)  
*Tap holes and water drain for siphon connection on the right*  
(installation to the left of the sink)

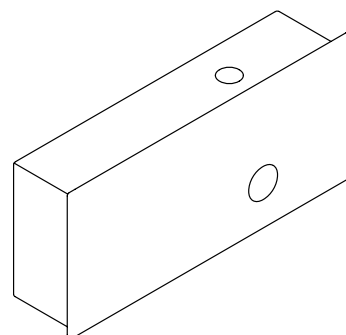

## SCHEMA 3 (OSL016)

Foro rubinetteria a destra  
*Right faucet hole*

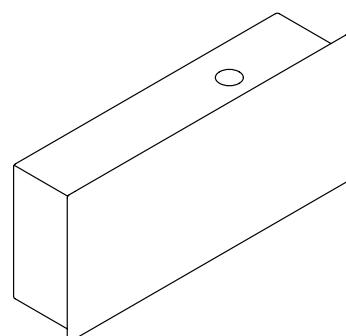

## SCHEMA 4 (OSL017)

Foro rubinetteria a sinistra  
*Left faucet hole*

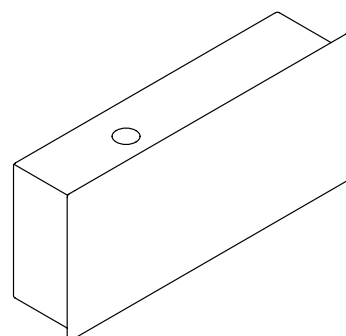

I fori verranno fatti dopo la fase di cottura del pezzo, quindi la ceramica potrebbe presentare delle leggere imperfezioni.

*The holes will be made after the firing process of the piece, so the ceramic may have slight imperfections.*

# PASSEPARTOUT STYLES

## CLASSIC COLORS



bianco lucido / glossy white



bianco matt / matt white



nero matt / matt black

## MATT COLORS



grigio oliva / grey olive



blu avio / blue avio



marrone matera / brown matera



sabbia / sand



ghiaia / gravel

## GLOSSY COLORS



curcuma / turmeric



paprika / paprika



edera / ivy



zefiro / zephyr

# PASSEPARTOUT OVERVIEW



## PASSEPARTOUT 52 x 23 p. 13

Mensola di ceramica, con Saniglaze

Schema 1

Fori rubinetteria e scarico acqua per collegamento sifone a sinistra

*Ceramic shelf, with Saniglaze  
Tap holes and water drain  
for siphon connection on the the left*



schede tecniche  
technical drawing

codice	colore	kg	pz. pallet Italia	pz. pallet Export	euro
CLASSIC COLORS					
OSL014	○ 01; 34	7	-	-	295
OSL014	◎ 05; 34	7	-	-	550
OSL014	● 17; 34	7	-	-	550
MATT COLORS					
OSL014		34	7	-	550
GLOSSY COLORS					
OSL014		34	7	-	550

\* tasselli per fissaggio lavabi sospesi, non inclusi con il lavabo

ACA007 0,3 - - 15

*fitting system kit for wall-hung washbasins, not included with the washbasin*



## PASSEPARTOUT 52 x 23 p. 13

Mensola di ceramica, con Saniglaze

Schema 2

Fori rubinetteria e scarico acqua per collegamento sifone a destra

*Ceramic shelf, with Saniglaze  
Tap holes and water drain for siphon  
connection on the the right*



schede tecniche  
technical drawing

codice	colore	kg	pz. pallet Italia	pz. pallet Export	euro
CLASSIC COLORS					
OSL015	○ 01; 34	7	-	-	295
OSL015	◎ 05; 34	7	-	-	550
OSL015	● 17; 34	7	-	-	550
MATT COLORS					
OSL015		34	7	-	550
GLOSSY COLORS					
OSL015		34	7	-	550

\* tasselli per fissaggio lavabi sospesi, non inclusi con il lavabo

ACA007 0,3 - - 15

*fitting system kit for wall-hung washbasins, not included with the washbasin*

# PASSEPARTOUT OVERVIEW



## PASSEPARTOUT 52 x 23 p. 13

Mensola di ceramica, con Saniglaze

Schema 3

Foro rubinetteria a destra

*Ceramic shelf, with Saniglaze  
Right faucet hole*



schede tecniche  
technical drawing

codice	colore	kg	pz. pallet Italia	pz. pallet Export	euro
CLASSIC COLORS					
OSL016	○ 01; 34	7	-	-	295
OSL016	◎ 05; 34	7	-	-	550
OSL016	● 17; 34	7	-	-	550
MATT COLORS					
OSL016		34	7	-	550
GLOSSY COLORS					
OSL016		34	7	-	550

\* tasselli per fissaggio lavabi sospesi, non inclusi con il lavabo

ACA007 0,3 - - 15

*fitting system kit for wall-hung washbasins, not included with the washbasin*



## PASSEPARTOUT 52 x 23 p. 13

mensola di ceramica, con Saniglaze

Schema 4

Foro rubinetteria a sinistra

*Ceramic shelf, with Saniglaze  
Left faucet hole*



schede tecniche  
technical drawing

codice	colore	kg	pz. pallet Italia	pz. pallet Export	euro
CLASSIC COLORS					
OSL017	○ 01; 34	7	-	-	295
OSL017	◎ 05; 34	7	-	-	550
OSL017	● 17; 34	7	-	-	550
MATT COLORS					
OSL017		34	7	-	550
GLOSSY COLORS					
OSL017		34	7	-	550

\* tasselli per fissaggio lavabi sospesi, non inclusi con il lavabo

ACA007 0,3 - - 15

*fitting system kit for wall-hung washbasins, not included with the washbasin*

# BOLD

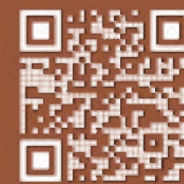

Scopri online  
Discover it online



Collezione di accessori bagno  
in metallo

Collection of metal bathroom  
accessories

# ACCESSORIES COLLECTION

Solid profiles, contemporary aesthetics.  
The Bold collection of bathroom accessories takes its name from its strong and marked design, in contrast with the usual slim profiles. It aims to balance fresh, contemporary aesthetics - enhanced by thicker shapes, colors, and finishes - with functionality, which remains the project's priority. The collection includes a towel rail, roll holder, toilet brush holder, hook, floor-mounted bathtub towel holder, and a floor-mounted roll holder with brush, all defined by a bold character that adds style to the bathroom space.

# Profili solidi, estetica contemporanea.

La collezione di accessori bagno Bold deve il suo nome al design marcato e deciso, in netto contrasto con i tradizionali profili slim. L'idea nasce dalla ricerca di un equilibrio tra un'estetica fresca e contemporanea, ottenuta grazie all'ispessimento delle forme e all'uso di colori e finiture particolari, e la funzionalità, che rimane sempre prioritaria. La linea comprende barra porta asciugamani, porta rotolo, porta scopino, gancio, piantana vasca porta asciugamani e piantana porta rotolo con scopino, tutti caratterizzati da una forte personalità che arreda lo spazio con stile.

ACA084 | 42 h 68

piantana portasciugamani  
in metallo

Floor metal towel holder  
bianco matt / matt white



**ACA080 | 45**

Porta salviette in metallo  
*Metal towel rail*

**ACA082**

Appendino singolo in metallo  
*Single metal hook*

**ACA084 | 42 h 68**

piantana portasciugamani  
in metallo  
*Floor metal towel holder*

**ACA083 | h 68**

Piantana portacarta/scopino  
in metallo  
*Floor metal roll paper/toilet  
brush holder*



# BOLD STYLES

## METALS



cod. 05  
bianco matt / matt white  
RAL 9016



cod. 17  
nero matt / matt black  
RAL 9005



cod. 56  
moka / moka  
RAL 8014

# BOLD OVERVIEW



	codice	colore	kg	pz. pallet Italia	pz. pallet Export	euro
<b>BOLD</b>	METALS					
porta carta in metallo <i>metal roll paper holder</i>	<b>ACA079</b>		0,2	-	-	<b>95</b>

	codice	colore	kg	pz. pallet Italia	pz. pallet Export	euro
<b>BOLD   45</b>	METALS					
porta salviette in metallo <i>metal towel rail</i>	<b>ACA080</b>		1	-	-	<b>260</b>

# BOLD OVERVIEW



	codice	colore	kg	pz. pallet Italia	pz. pallet Export	euro
<b>BOLD   h 40</b>	METALS					
porta scopino metallo con scopino <i>metal toilet brush holder with brush</i>	<b>ACA081</b>		0,4	-	-	<b>200</b>

	codice	colore	kg	pz. pallet Italia	pz. pallet Export	euro
<b>BOLD</b>	METALS					
appendino singolo in metallo <i>single metal hook</i>	<b>ACA082</b>		0,1	-	-	<b>70</b>

	codice	colore	kg	pz. pallet Italia	pz. pallet Export	euro
<b>BOLD   h 68</b>	METALS					
piantana porta carta/scopino in metallo <i>floor metal roll paper/toilet brush holder</i>	<b>ACA083</b>		6,5	-	-	<b>530</b>

	codice	colore	kg	pz. pallet Italia	pz. pallet Export	euro
<b>BOLD   42 h 68</b>	METALS					
piantana porta asciugamani in metallo <i>floor metal towel holder</i>	<b>ACA084</b>		8,5	-	-	<b>470</b>

# SHOWER TRAYS

PIATTI DOCCIA  
THE.ARTCERAM

AQUANIT (P.670)  
LAPIS (P.682)

# AQUA NIT



Scopri online  
Discover it online

Collezione di piatti doccia  
filopavimento

Collection of flush-to-floor  
shower trays

# SHOWER TRAYS COLLECTION



SHOWER TRAYS

Minimalism at its Purest.  
With a reduced thickness of just 15 mm, The.Artceram's Aquanit shower trays redefine the concept of minimalism in the bathroom, offering an exceptionally sleek and modern solution. Crafted entirely from 100% porcelain, they combine the beauty of ceramics with top-tier technical features, ensuring a comfort experience without compromise.

# Minimalismo allo stato puro.

Con uno spessore ridotto di soli 15mm, i piatti doccia Aquanit di The.Artceram ridefiniscono il concetto di minimalismo nel bagno, offrendo una soluzione straordinariamente sottile e moderna. Realizzati interamente in porcellana al 100%, combinano la bellezza della ceramica con caratteristiche tecniche di altissimo livello, per un'esperienza di comfort senza compromessi.



**PDR038 | 90 x 135**  
Piatto doccia filo pavimento  
*Flush-to-floor shower tray*

PDR038 | 90 x 135

Piatto doccia filo pavimento  
Flush-to-floor shower tray



Thanks to their minimalist design and a single slab molded with the perfect slope for optimal water drainage, Aquanit shower trays seamlessly blend aesthetics and functionality. They are available in six sizes and feature rectified, color-matched edges for a refined finish. The reduced thickness makes them ideal for flush-to-floor installation - a detail that not only removes architectural barriers but enhances the style of walk-in showers, transforming the bathroom into a continuous, elegant, and functional space.

Grazie al loro design minimalista e alla lastra unica stampata con la corretta inclinazione per garantire il deflusso ottimale dell'acqua, i piatti doccia Aquanit coniugano estetica e funzionalità; sono disponibili in sei dimensioni e con lati rettificati in tinta. Lo spessore ridotto li rende perfetti per l'installazione a filo pavimento, un dettaglio che non solo elimina ogni barriera architettonica, ma esalta lo stile delle docce walk-in, trasformando lo spazio bagno in un ambiente continuo, elegante e funzionale.

# AQUANIT SYSTEM

I piatti doccia Aquanit combinano innovazione, design e funzionalità. Sono realizzati in porcellana al 100%, una scelta che garantisce durabilità e una superficie igienica perfetta. Con uno spessore ridotto di soli 15 mm, offrono un accesso facile e senza barriere all'area doccia, ideale per soluzioni walk-in. La finitura antiscivolo e antimacchia assicura sicurezza e praticità, mentre la lastra unica con inclinazione integrata garantisce un drenaggio facile ed efficiente. Un prodotto che unisce funzionalità, estetica e innovazione, per un'esperienza di comfort senza compromessi. I piatti doccia Aquanit sono progettati per l'installazione a filo pavimento, lo spessore dei bordi non è dello stesso colore della superficie superiore, ed inoltre non sono tagliabili su misura.

*Aquanit shower trays combine innovation, design, and functionality. Made of 100% porcelain, this choice ensures durability and a perfectly hygienic surface. With a slim thickness of just 15 mm, they provide easy, barrier-free access to the shower area, making them ideal for walk-in solutions. The anti-slip and stain-resistant finish ensures safety and practicality, while the single slab with integrated slope guarantees easy and efficient drainage. A product that combines functionality, aesthetics, and innovation for a comfort experience without compromise. Aquanit shower trays are designed for flush-to-floor installation, the edge thickness is not the same color as the top surface, and moreover they cannot be custom-cut.*

## PDR035 | 120 x 80

Piatto doccia filo pavimento  
Flush-to-floor shower tray

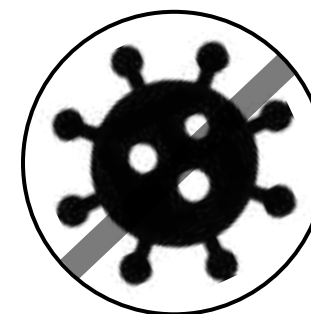

superficie igienica  
hygienic



facile accesso all'area doccia  
easy access to the shower area

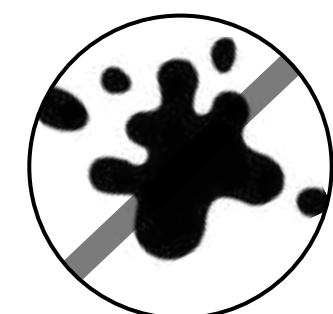

antimacchia  
stain resistant

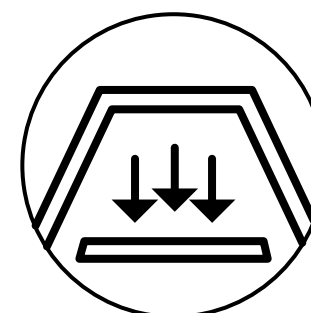

drenaggio facile  
easy drainage



antiscivolo  
non-slip



100% ceramica  
100% porcelain tile

# AQUANIT STYLES



cod. 05  
bianco matt / matt white



cod. 74  
cemento matt / matt concrete

# AQUANIT OVERVIEW



## AQUANIT | 80 x 80

piatto doccia filo pavimento  
con griglia inox inclusa

*flush-to-floor shower tray  
with stainless grid included*



schede tecniche  
technical drawing

codice	colore	kg	pz. pallet Italia	pz. pallet Export	euro
PDR033	○ 05; 00	21	9	9	320
PDR033	● 74; 00	21	9	9	320



## AQUANIT | 90 x 90

piatto doccia filo pavimento  
con griglia inox inclusa

*flush-to-floor shower tray  
with stainless grid included*



schede tecniche  
technical drawing

codice	colore	kg	pz. pallet Italia	pz. pallet Export	euro
PDR034	○ 05; 00	26	9	9	330
PDR034	● 74; 00	26	9	9	330



## AQUANIT | 120 x 80

piatto doccia filo pavimento  
con griglia inox inclusa

*flush-to-floor shower tray  
with stainless grid included*



schede tecniche  
technical drawing

codice	colore	kg	pz. pallet Italia	pz. pallet Export	euro
PDR035	○ 05; 00	31	9	9	350
PDR035	● 74; 00	31	9	9	350

# AQUANIT OVERVIEW



## AQUANIT | 135 x 90

piatto doccia filo pavimento  
con griglia inox inclusa

*flush-to-floor shower tray  
with stainless grid included*



schede tecniche  
technical drawing

codice	colore	kg	pz. pallet Italia	pz. pallet Export	euro
PDR036	○ 05; 00	39	9	9	365
PDR036	● 74; 00	39	9	9	365



## AQUANIT | 80 x 120

piatto doccia filo pavimento  
con griglia inox inclusa

*flush-to-floor shower tray  
with stainless grid included*



schede tecniche  
technical drawing

codice	colore	kg	pz. pallet Italia	pz. pallet Export	euro
PDR037	○ 05; 00	31	9	9	350
PDR037	● 74; 00	31	9	9	350



## AQUANIT | 90 x 135

piatto doccia filo pavimento  
con griglia inox inclusa

*flush-to-floor shower tray  
with stainless grid included*



schede tecniche  
technical drawing

codice	colore	kg	pz. pallet Italia	pz. pallet Export	euro
PDR038	○ 05; 00	39	9	9	370
PDR038	● 74; 00	39	9	9	370

# AQUANIT ACCESSORIES

	codice	colore	kg	pz. pallet Italia	pz. pallet Export	euro
griglia inox 50cm per piatti doccia Aquanit PDR033, PDR034, PDR037, PDR038	ACA095	● 55	-	-	-	60

*50cm stainless steel grid for  
Aquanit shower trays PDR033,  
PDR034, PDR037, PDR038*

	codice	colore	kg	pz. pallet Italia	pz. pallet Export	euro
griglia inox 70cm per piatti doccia Aquanit PDR035, PDR036	ACA098	● 55	-	-	-	60

*70cm stainless steel grid for  
Aquanit shower trays PDR035,  
PDR036*

	codice	colore	kg	pz. pallet Italia	pz. pallet Export	euro
sifone ribassato obbligatorio compulsory lowered siphon	ACA094		55	-	-	45

# LAPIS



Scopri la online  
Discover it online

Collezione di piatti doccia  
in ceramica

Collection of ceramic  
shower trays



# SHOWER TRAYS COLLECTION

Pure Design.  
A line of ceramic shower trays entirely “Made in Italy”.  
High-pressure casting technology ensures a natural, solid,  
and highly textured finish with outstanding definition.  
Available in matt colours with a non-slip finish and in  
various reversible sizes - glazed on all four sides - they are  
designed to blend seamlessly into any bathroom setting.

# Design essenziale.

Linea di piatti doccia in ceramica  
interamente “Made in Italy”.  
La tecnologia di produzione  
ad alta pressione consente di  
ottenere una finitura naturale e  
straordinariamente materica, con  
dettagli di altissima definizione.  
Disponibili in colori opachi con  
finitura antiscivolo e in diversi  
formati reversibili - smaltati su tutti i  
4 lati - sono progettati per integrarsi  
con armonia in qualsiasi ambiente  
bagno.

## **PDR026 | 120 x 80**

Piatto doccia in ceramica  
bianco matt / nero matt  
*Ceramic shower tray  
matt white / matt black*

## **PDR027 | 140 x 70**

Piatto doccia in ceramica  
*Ceramic shower tray  
sabbia / sand*

## **PDR028 | 140 x 80**

Piatto doccia in ceramica  
*Ceramic shower tray  
ghiaia / gravel*



PDR028 | 140 x 80

Piatto doccia in ceramica  
Ceramic shower tray



With a thickness of just 3 cm, the shower trays can be installed directly on the floor. Coordinated high-quality accessories, such as the special drain (in stainless steel or in the same colour as the tray), complete the collection and ensure maximum aesthetic performance.

Con uno spessore di soli 3 cm, i piatti doccia possono essere installati in appoggio a pavimento. Accessori coordinati di altissima qualità, come la speciale piletta (in acciaio o in tinta con il piatto doccia), completano la collezione garantendo il massimo risultato estetico.

# LAPIS SYSTEM

La ceramica in alta-pressione conferisce a Lapis un'affidabilità nel tempo senza paragoni, consentendo di ottenere un prodotto di elevatissima qualità utilizzando solo materiali naturali, in contrapposizione netta con i compositi sintetici e le resine epossidiche. Lo smalto ceramico antibatterico rende particolarmente igienico il piatto doccia, facile da pulire (anti-macchia, testato UNI 4543) e conferisce caratteristiche nettamente superiori in termini di durata e resistenza rispetto alle superfici in resina (che contrariamente sono porose, e potrebbero tendere ad assorbire agenti esterni). Infine lo smalto di Lapis è arricchito con proprietà anti-scivolo (aderenti alle normative Europee DIN 51097) per assicurare la massima sicurezza durante l'utilizzo.

*The high-pressure casting technology give Lapis an incomparable reliability through the years by producing a product of very-high quality and using only natural materials in stark contrast to composite materials and epoxy resins. The use of the anti-bacterial glaze make these shower trays really hygienic, easy-to-clean (cannot be stained as per test UNI 4543) characterized by superior qualities in terms of product-life and resistance as opposed to the resin surfaces (these are porous and can absorb or be easily attacked by external agents). Last but not least, the glazed sprayed on Lapis is enriched by anti-slip features (complying with European Standard Rules DIN 51097) to assure maximum safety during the use.*

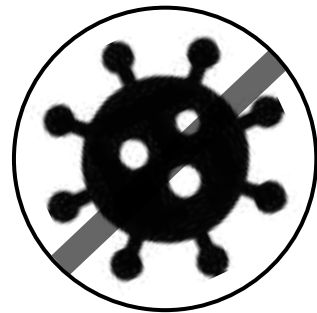

superficie igienica  
*hygienic*



facile da pulire  
*easy-to-clean*



antimacchia  
*stain resistant*



resistente agli acidi  
*resistant to acids*



antiscivolo  
*non-slip*



reversibile, smaltato su 4 lati  
*reversible, glazed on the 4 sides*

# LAPIS STYLES

## CLASSIC COLORS



cod. 05  
bianco matt / *matt white*



cod. 17  
nero matt / *matt black*

## MATT COLORS



cod. 59  
sabbia / *sand*

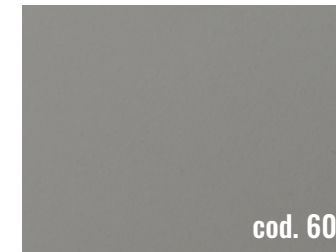

cod. 60  
ghiaia / *gravel*

# LAPIS OVERVIEW



## LAPIS | 100 x 70 h 3

piatto doccia in ceramica  
antiscivolo

*non-slip ceramic shower tray*



schede tecniche  
technical drawing

codice	colore	kg	pz. pallet Italia	pz. pallet Export	euro
CLASSIC COLORS					
PDR023	05; 00	27	10	10	550
PDR023	17; 00	27	10	10	550
MATT COLORS					
PDR023		27	10	10	550



## LAPIS | 100 x 80 h 3

piatto doccia in ceramica  
antiscivolo

*non-slip ceramic shower tray*



schede tecniche  
technical drawing

codice	colore	kg	pz. pallet Italia	pz. pallet Export	euro
CLASSIC COLORS					
PDR024	05; 00	28	10	10	590
PDR024	17; 00	28	10	10	590
MATT COLORS					
PDR024		28	10	10	590



## LAPIS | 120 x 70 h 3

piatto doccia in ceramica  
antiscivolo

*non-slip ceramic shower tray*



schede tecniche  
technical drawing

codice	colore	kg	pz. pallet Italia	pz. pallet Export	euro
CLASSIC COLORS					
PDR025	05; 00	34	10	10	650
PDR025	17; 00	34	10	10	650
MATT COLORS					
PDR025		34	10	10	650



## LAPIS | 120 x 80 h 3

piatto doccia in ceramica  
antiscivolo

*non-slip ceramic shower tray*



schede tecniche  
technical drawing

codice	colore	kg	pz. pallet Italia	pz. pallet Export	euro
CLASSIC COLORS					
PDR026	05; 00	38	10	10	695
PDR026	17; 00	38	10	10	695
MATT COLORS					
PDR026		38	10	10	695

# LAPIS OVERVIEW



## LAPIS | 140 x 70 h 3

piatto doccia in ceramica  
antiscivolo

*non-slip ceramic shower tray*



schede tecniche  
technical drawing

codice	colore	kg	pz. pallet Italia	pz. pallet Export	euro
CLASSIC COLORS					
PDR027	05; 00	40	10	10	710
PDR027	17; 00	40	10	10	710
MATT COLORS					
PDR027		40	10	10	710



## LAPIS | 140 x 80 h 3

piatto doccia in ceramica  
antiscivolo

*non-slip ceramic shower tray*



schede tecniche  
technical drawing

codice	colore	kg	pz. pallet Italia	pz. pallet Export	euro
CLASSIC COLORS					
PDR028	05; 00	45	10	10	825
PDR028	17; 00	45	10	10	825
MATT COLORS					
PDR028		45	10	10	825



## LAPIS | 80 x 80 h 3

piatto doccia in ceramica  
antiscivolo

*non-slip ceramic shower tray*



schede tecniche  
technical drawing

codice	colore	kg	pz. pallet Italia	pz. pallet Export	euro
CLASSIC COLORS					
PDR029	05; 00	22	10	10	395
PDR029	17; 00	22	10	10	395
MATT COLORS					
PDR029		22	10	10	395



## LAPIS | 90 x 70 h 3

piatto doccia in ceramica  
antiscivolo

*non-slip ceramic shower tray*



schede tecniche  
technical drawing

codice	colore	kg	pz. pallet Italia	pz. pallet Export	euro
CLASSIC COLORS					
PDR030	05; 00	25	10	10	400
PDR030	17; 00	25	10	10	400
MATT COLORS					
PDR030		25	10	10	400

# LAPIS OVERVIEW



## LAPIS | 90 x 80 h 3

piatto doccia in ceramica  
antiscivolo

*non-slip ceramic shower tray*



schede tecniche  
technical drawing



## LAPIS | 120 x 90 h 3

piatto doccia in ceramica  
antiscivolo

*non-slip ceramic shower tray*



schede tecniche  
technical drawing

codice	colore	kg	pz. pallet Italia	pz. pallet Export	euro
CLASSIC COLORS					
<b>PDR031</b>	○ 05; 00	27	10	10	<b>540</b>
<b>PDR031</b>	● 17; 00	27	10	10	<b>540</b>
MATT COLORS					
<b>PDR031</b>		27	10	10	<b>540</b>

codice	colore	kg	pz. pallet Italia	pz. pallet Export	euro
CLASSIC COLORS					
<b>PDR032</b>	○ 05; 00	45	10	10	<b>850</b>
<b>PDR032</b>	● 17; 00	45	10	10	<b>850</b>
MATT COLORS					
<b>PDR032</b>		45	10	10	<b>850</b>

# LAPIS ACCESSORIES



piletta sifonata Ø90  
per piatti doccia

*drain Ø90 for shower tray*

codice	colore	kg	pz. pallet Italia	pz. pallet Export	euro
<b>ACA071</b>		0,3	-	-	<b>40</b>

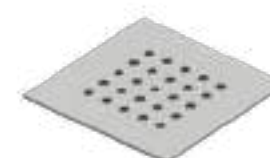

griglia inox per piletta ACA071

*inox cover for drain ACA071*

La piletta in tinta è disponibile solo per le varianti cromatiche riportate nella tabella listino qui a lato

codice	colore	kg	pz. pallet Italia	pz. pallet Export	euro
CLASSIC COLORS					
<b>PDR027</b>	● 71; 00	0,6	-	-	<b>60</b>
<b>PDR027</b>	○ 05; 00	0,6	-	-	<b>80</b>
<b>PDR027</b>	● 17; 00	0,6	-	-	<b>80</b>
MATT COLORS					
<b>PDR027</b>		0,6	-	-	<b>80</b>

*The matching drain is only available for the color variations shown in the price list chart on the side steel finish / ACA072 71*

\* É obbligatorio acquistare ed installare la piletta sifonata e la griglia di copertura per montare i piatti doccia!

*You must purchase and install the drain and the cover grid for mounting the shower trays!*

# BATH TUBS

VASCHE DA BAGNO  
THE.ARTCERAM

PETITE (P.696)  
HOOP (P.704)  
HERMITAGE (P.712)

# PETTI TE



Scopri online  
Discover it online



Vasca freestanding  
in Livingtec

Freestanding bathtub  
in Livingtec

# FREESTANDING BATHTUB

Small, Elegant, Welcoming.  
Petite is a small elegant urban bathtub which can be installed in small romantic spaces where details are taken care of. It's a small freestanding but capacious bathtub designed to offer maximum comfort and relax even in small spaces.

# Piccola, elegante, accogliente.

Petite è una piccola e graziosa vasca urbana, adatta a tutti quegli ambienti ristretti che hanno bisogno di romanticismo, cura e attenzione nei dettagli. Una vasca freestanding di dimensioni contenute e grande capienza, pensata per offrire il massimo del comfort e relax anche nei piccoli ambienti.

ACW005 | 140 x 70

Vasca freestanding in Livingtec  
*Freestanding bathtub in Livingtec*





**ACW005 | 140 x 70**

Vasca freestanding in Livingtec  
Freestanding bathtub in Livingtec

140 x 70 x 50 cm that ideally recall a tub, a past souvenir adopted when the water was considered a precious element...as it is now. Artceram re-interprets that bathtub idea with the goal of reducing the use of water through a small element, small but elegant where the rim invites the end-user to dip and relax without feeling guilty.

140 x 70 x 50 cm sono le sue dimensioni che rimandano idealmente alla tinozza, alla memoria di un oggetto perduto, memoria di un tempo dove l'acqua era un bene prezioso... proprio come adesso. Artceram interpreta così il tema della vasca e della necessità di ridurre l'utilizzo dell'acqua con una elemento contenuto, tanto piccolo quanto garbato, dove il bordo superiore idealmente invita ad immergersi e a rilassarsi senza sentirsi in colpa.

### ACW005 | 140 x 70

Vasca freestanding in Livingtec  
Freestanding bathtub in Livingtec



## PETITE STYLES

### CLASSIC COLORS



bianco lucido / glossy white



bianco matt / matt white



nero matt / matt black

## PETITE OVERVIEW



### PETITE| 140 x 70

vasca freestanding  
in Livingtec con troppopieno,  
sifone e copripiletta  
abbinata inclusa

*freestanding bathtub  
in Livingtec with overflow,  
siphon and matching drain  
cover included*



schede tecniche  
technical drawing

codice	colore	kg	pz. pallet Italia	pz. pallet Export	euro
CLASSIC COLORS					
ACW005	01; 00	100	-	-	5150
ACW005	05; 00	100	-	-	4000
ACW005	17; 00	100	-	-	5150

# HOOP

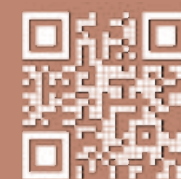

Scopri online  
Discover it online

Vasca freestanding  
in Livingtec

Freestanding bathtub  
in Livingtec



# FREESTANDING BATHTUB

A geometry that embraces.  
Hoop is a freestanding bathtub with a bold and contemporary character. Its soft, continuous shapes form a balanced and harmonious volume, able to complement modern and elegant architectural spaces. With its generous dimensions, Hoop offers a deeply immersive and comfortable bathing experience. The oval lines naturally cradle the body, inviting relaxation and a suspension of time, turning the everyday act of bathing into a ritual of well-being.

# Una geometria che accoglie.

Hoop è una vasca freestanding dal carattere deciso e contemporaneo. Le sue forme morbide e continue disegnano un volume equilibrato e armonico, capace di dialogare con ambienti architettonici moderni ed eleganti. Con le sue dimensioni generose, Hoop offre un'esperienza di immersione profonda e confortevole. La linea ovale accompagna il corpo in modo naturale, invitando al relax e alla sospensione del tempo, trasformando il gesto quotidiano del bagno in un rituale di benessere.

ACW002 | 170 x 70

Vasca freestanding in Livingtec  
Freestanding bathtub in Livingtec  
marrone matera / brown matera



ACW002 | 170 x 70

Vasca freestanding in Livingtec  
Freestanding bathtub in Livingtec



ACW002 | 170 x 70

Vasca freestanding in Livingtec  
Freestanding bathtub in Livingtec  
grigio oliva / grey olive



Made in Livingtec, a compact, durable, and pleasant-to-the-touch material, Hoop guarantees high functional performance and long-lasting durability. Its smooth, non-porous surface highlights the purity of its forms and accommodates a wide range of finishes, from classic colors to contemporary matte and glossy tones. Hoop interprets the bathroom as an intimate and sensory space: a silent yet striking presence, capable of defining the environment with elegance and personality.

Realizzata in Livingtec, materiale compatto, resistente e piacevole al tatto, Hoop garantisce elevate prestazioni funzionali e una lunga durata nel tempo. La superficie liscia e non porosa valorizza la purezza delle forme e accoglie una vasta gamma di finiture, dai colori classici alle tonalità opache e lucide più contemporanee. Hoop interpreta il bagno come spazio intimo e sensoriale: una presenza silenziosa ma scenografica, capace di definire l'ambiente con eleganza e personalità.

# HOOP STYLES

## CLASSIC COLORS



cod. 01  
bianco lucido / glossy white



cod. 05  
bianco matt / matt white



cod. 17  
nero matt / matt black

## MATT COLORS



cod. 15  
grigio oliva / grey olive



cod. 38  
blu avio / blue avio



cod. 41  
marrone matera / brown matera



cod. 59  
sabbia / sand



cod. 60  
ghiaia / gravel

## GLOSSY COLORS



cod. 67  
curcuma / turmeric



cod. 68  
paprika / paprika



cod. 69  
edera / ivy



cod. 70  
zefiro / zephyr

# HOOP OVERVIEW



## HOOP | 170 x 70

vasca freestanding  
in Livingtec con troppopieno,  
sifone e copripiletta  
abbinata inclusa

freestanding bathtub  
in Livingtec with overflow,  
siphon and matching drain  
cover included



schede tecniche  
technical drawing

codice	colore	kg	pz. pallet Italia	pz. pallet Export	euro
CLASSIC COLORS					
ACW002	○ 01; 00	115	-	-	5400
ACW002	◎ 05; 00	115	-	-	4150
ACW002	● 17; 00	115	-	-	5400
MATT COLORS					
ACW002		115	-	-	5400
GLOSSY COLORS					
ACW002		115	-	-	5400

# HER MITA GE



Scopri online  
Discover it online

Vasca freestanding  
con accessori metallici

Freestanding bathtub  
with metal accessories



## FREESTANDING BATHTUB

Timeless Well-being.  
The Hermitage bathtub embodies classic elegance through its iconic paw feet inspired by Old England style, bringing a regal and refined charm to the bathroom. Soft lines and harmonious curves shape a timeless silhouette, enhanced by the glossy white finish and understated metallic fittings and perfectly coordinated with the classic collection.

# Benessere senza tempo.

La vasca Hermitage celebra l'eleganza classica con i suoi iconici piedini a zampa ispirati allo stile Old England, che donano al bagno un fascino regale e raffinato. Le linee morbide e le curve armoniose definiscono una silhouette senza tempo, valorizzata dalla finitura bianco lucido e dagli accessori metallici dal lusso discreto, perfettamente coordinabili con gli elementi della collezione classica.

HEW001 | 170 x 80

Vasca con accessori metallici  
Bathtub with metal accessories



HEW001 | 170 x 80

Vasca con accessori metallici  
Bathtub with metal accessories



## HERMITAGE STYLES

### CLASSIC COLORS



bianco lucido / glossy white

### METALS



bianco lucido / glossy white



cromato / chrome



bronzo / bronze



oro / gold

## HERMITAGE OVERVIEW



### HERMITAGE | 170 x 80 h 72

vasca bianca con accessori  
metallici bianchi, cromo, bronzo,  
oro

white bathtub with metal  
accessories white, chrome,  
bronze, gold



schede tecniche  
technical drawing

codice	colore	kg	pz. pallet Italia	pz. pallet Export	euro
METALS					
HEW001	76	40	-	-	3050
HEW001	71	40	-	-	3400
HEW001	72	40	-	-	3400
HEW001	73	40	-	-	3400

# SPARE PARTS

PEZZI DI RICAMBIO  
THE.ARTCERAM

# SPARE PARTS STYLES



cod. 76

bianco lucido / glossy white



cod. 71

cromato / chrome



cod. 72

bronzo / bronze



cod. 73

oro / gold



cod. 77

oro rosa / pink gold

# SPARE PARTS OVERVIEW

## KIT CERNIERE / HINGES KITS



### CHIC

kit cerniere frizionate per Chic  
cromo, bronzo, oro

*soft-close hinges kit for Chic  
chrome, bronze, gold*

codice	colore	kg	pz. pallet Italia	pz. pallet Export	euro
CHA002	71	0,3	-	-	50
CHA002	73	0,3	-	-	70



### AZULEY/ATELIER

kit cerniere frizionate  
per Azuley cromo, bronzo, oro

*soft-close hinges kit for Azuley  
chrome, bronze, gold*

AZA004	71	0,3	-	-	58
--------	----	-----	---	---	----



### JAZZ

kit cerniere frizionate per Jazz  
cromo, bronzo, oro

*soft-close hinges kit for Jazz  
chrome, bronze, gold*

JZA008	71	0,3	-	-	58
--------	----	-----	---	---	----



### CIVITAS

kit cerniere frizionate per  
Civitas cromo, oro rosa, oro

*soft-close hinges kit for Civitas  
chrome, pink gold, gold*

CIA016	71	0,3	-	-	58
CIA016	77	0,3	-	-	81
CIA016	73	0,3	-	-	81



## HERMITAGE

kit cerniere frizionate  
per Hermitage  
cromo, bronzo, oro

*soft-close hinges kit  
for Hermitage  
chrome, bronze, gold*

codice	colore	kg	pz. pallet Italia	pz. pallet Export	euro
HEA112	71	0,3	-	-	92
HEA112	72	0,3	-	-	109
HEA112	73	0,3	-	-	109



## A16

kit cerniere frizionate per A16

*soft-close hinges kit for A16*

ASA003	0,3	-	-	58
--------	-----	---	---	----



## FILE 2.0

kit cerniere frizionate per FLA002

*soft-close hinges kit for FLA002*

FLA005	0,3	-	-	58
--------	-----	---	---	----



## FILE 2.0

kit cerniere per FLA003

*hinges kit for FLA003*

FLA006	0,3	-	-	35
--------	-----	---	---	----



## FILE 2.0

kit fissaggio per FLA014

*fixing kit for FLA014*

codice	colore	kg	pz. pallet Italia	pz. pallet Export	euro
FLA015		0,3	-	-	25



## TEN

kit cerniere per TEA002

*hinges kit for TEA002*

TEA004	0,3	-	-	35
--------	-----	---	---	----



## TEN

kit cerniere frizionate  
per TEA005

*soft-close hinges kit for TEA005*

TEA006	0,3	-	-	58
--------	-----	---	---	----



## VITA / SOLIDA

kit cerniere frizionate  
per FLA016/FLA018

*soft-close hinges kit  
for FLA016/FLA018*

FLA020	0,3	-	-	58
--------	-----	---	---	----



### SETA

kit cerniere frizionate per SEA001

*soft-close hinges kit for SEA001*

codice	colore	kg	pz. pallet Italia	pz. pallet Export	euro
SEA002		0,3	-	-	58



### MONET

kit cerniere frizionate per Monet

*soft-close hinges kit for Monet*

codice	colore	kg	pz. pallet Italia	pz. pallet Export	euro
MNA002		0,3	-	-	58

## CURVE TECNICHE E MANICOTTI / PIPES AND ECCENTRIC PIPES



curva tecnica S

*elbow at floor S*

codice	colore	kg	pz. pallet Italia	pz. pallet Export	euro
ACA005		0,3	-	-	25



curva tecnica a 90°  
per File 2.0

*90° elbow for File 2.0*

codice	colore	kg	pz. pallet Italia	pz. pallet Export	euro
ACA033		0,3	-	-	35



curva tecnica traslata  
per File 2.0

*adjustable pipe for File 2.0*

codice	colore	kg	pz. pallet Italia	pz. pallet Export	euro
ACA034		0,3	-	-	35



curva tecnica traslata

*adjustable pipe*

codice	colore	kg	pz. pallet Italia	pz. pallet Export	euro
ACA074		0,3	-	-	40



raccordo scarico parete "P"  
traslato

*"P" trap adjustable pipe*

codice	colore	kg	pz. pallet Italia	pz. pallet Export	euro
<b>ACA075</b>		0,3	-	-	<b>25</b>



manicotto concentrico

*concentric pipe*

codice	colore	kg	pz. pallet Italia	pz. pallet Export	euro
<b>ACA076</b>		0,2	-	-	<b>20</b>



manicotto eccentrico 2 cm

*eccentric pipe 2 cm*

codice	colore	kg	pz. pallet Italia	pz. pallet Export	euro
<b>ACA077</b>		0,2	-	-	<b>20</b>



manicotto eccentrico 4 cm

*eccentric pipe 4 cm*

codice	colore	kg	pz. pallet Italia	pz. pallet Export	euro
<b>ACA078</b>		0,2	-	-	<b>25</b>



cannotto traslato per modifica  
ingresso acqua +/- 2 cm

*adjustable pipe for water inlet  
change +/-2 cm*

codice	colore	kg	pz. pallet Italia	pz. pallet Export	euro
<b>ACA035</b>		0,2	-	-	<b>29</b>



raccordo a parete P

*pipe at wall P*

codice	colore	kg	pz. pallet Italia	pz. pallet Export	euro
<b>ACA004</b>		0,3	-	-	<b>29</b>

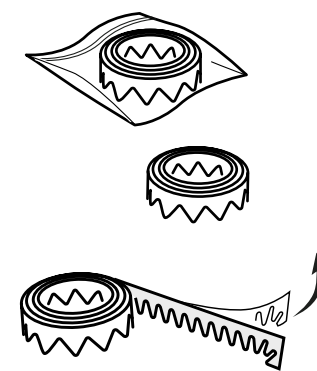

protezione adesiva antirumore  
zig/zag

*soundproof zig/zag*

codice	colore	kg	pz. pallet Italia	pz. pallet Export	euro
<b>ACA104</b>		0,3	-	-	<b>15</b>

## FISSAGGI / FITTING SYSTEMS



kit fissaggio laterale per sanitari obbligatorio

*mandatory fitting system kit for sanitaryware*

codice	colore	kg	pz. pallet Italia	pz. pallet Export	euro
<b>ACA020</b>		0,3	-	-	<b>15</b>



kit fissaggio nascosto per sanitari filomuro obbligatorio

*mandatory hidden fitting system kit for back to wall sanitaryware*

codice	colore	kg	pz. pallet Italia	pz. pallet Export	euro
<b>ACA039</b>		0,3	-	-	<b>25</b>



staffe di fissaggio per sospesi

*fitting system kit for wall-hung*

codice	colore	kg	pz. pallet Italia	pz. pallet Export	euro
<b>ACA016</b>		1	-	-	<b>70</b>



tasselli per fissaggio lavabi sospesi, non inclusi con il lavabo

*fitting system kit for wall-hung washbasins, not included with the washbasin*

codice	colore	kg	pz. pallet Italia	pz. pallet Export	euro
<b>ACA007</b>		0,3	-	-	<b>15</b>



staffe per fissaggio lavabi sottopiano

*fitting system kit for under-countertop washbasins*

codice	colore	kg	pz. pallet Italia	pz. pallet Export	euro
<b>ACA001</b>		0,3	-	-	<b>12</b>



kit fissaggio per sanitari sospesi obbligatorio

*mandatory fitting system kit for wall-hung sanitaryware*

codice	colore	kg	pz. pallet Italia	pz. pallet Export	euro
<b>ACA052</b>		0,3	-	-	<b>25</b>



fissaggio verticale per sanitari a terra

*vertical fitting system kit for back to wall wcs*

codice	colore	kg	pz. pallet Italia	pz. pallet Export	euro
<b>ACA103</b>		0,3	-	-	<b>15</b>

## SIFONI / SIPHONS



sifone ridotto  
*reduced siphon*

codice	colore	kg	pz. pallet Italia	pz. pallet Export	euro
<b>ACA021</b>		1	-	-	<b>100</b>



sifone cilindrico cromo  
*chrome siphon*

codice	colore	kg	pz. pallet Italia	pz. pallet Export	euro
<b>ACA022</b>		1	-	-	<b>130</b>

sifone cilindrico  
*siphon*

codice	colore	kg	pz. pallet Italia	pz. pallet Export	euro
<b>ACA099</b>	05	1	-	-	<b>180</b>
<b>ACA099</b>	17	1	-	-	<b>180</b>

## MECCANISMI DI SCARICO / FLOW SYSTEMS



meccanismo di scarico doppio flusso per FLC001  
*waste system double flow for FLC001*

codice	colore	kg	pz. pallet Italia	pz. pallet Export	euro
<b>FLA001</b>		1	-	-	<b>105</b>



**HERMITAGE**  
meccanismo di scarico doppio flusso con galleggiante universale per HEC001  
*double flow discharge, standard valve mechanism for HEC001*

codice	colore	kg	pz. pallet Italia	pz. pallet Export	euro
<b>HEA010</b>		1	-	-	<b>98</b>



**HERMITAGE**  
meccanismo scarico con maniglia frontale e tubo esterno di scarico per HEC005  
*flushing system with metal front handle and flush pipe for HEC005*

METALS					
<b>HEA013</b>	71	1	-	-	<b>480</b>
<b>HEA013</b>	77	1	-	-	<b>600</b>
<b>HEA013</b>	73	1	-	-	<b>600</b>



**HERMITAGE**  
batteria scarico, pull in ceramica, catenella e tubo scarico in metallo per HEC004  
*flushing system, with ceramic pull, metal chain and flush pipe for HEC004*

METALS					
<b>HEA006</b>	71	1	-	-	<b>480</b>
<b>HEA006</b>	77	1	-	-	<b>600</b>
<b>HEA006</b>	73	1	-	-	<b>600</b>



cisterna pvc con dispositivo di scarico doppio flusso

*plastic cistern with waste system double flow*

codice	colore	kg	pz. pallet Italia	pz. pallet Export	euro
<b>ACA006</b>		1	-	-	<b>207</b>



cassetta incasso a muro doppio scarico per Wc sospesi 3-6 litri

*concealed cistern double flow discharge for wall-hung Wcs 3-6 litres*



schede tecniche  
technical drawing

<b>ACA041</b>		3	-	-	<b>440</b>
---------------	--	---	---	---	------------



cassetta incasso Sanitarblock scarico per Wc sospesi e smart toilet

*concealed cistern Sanitarblock discharge for wall-hung Wcs and smart toilet*



schede tecniche  
technical drawing

<b>ACA088</b>		3	-	-	<b>460</b>
---------------	--	---	---	---	------------



placca slim dual per ACA041 e ACA088

*slim dual flush plate for ACA041 and ACA088*

<b>ACA107</b>		71	0,6	-	-	<b>140</b>
<b>ACA107</b>		01	0,6	-	-	<b>140</b>
<b>ACA107</b>		05	0,6	-	-	<b>140</b>
<b>ACA107</b>		17	0,6	-	-	<b>140</b>



riduttore di flusso regolabile per adduzione wc

*adjustable flow reducer for wc water inlet*

codice	colore	kg	pz. pallet Italia	pz. pallet Export	euro
<b>ACA064</b>		-	-	-	<b>15</b>

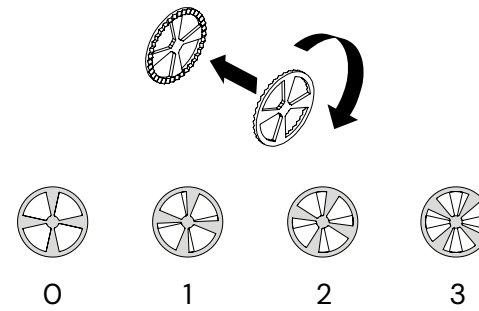

a seconda del posizionamento aumenta o riduce il flusso d'acqua

*depending on the positioning increases or reduces the water flow*

## PILETTE / DRAINS



piletta sifonata Ø90  
per piatti doccia

*drain Ø90 for shower tray*

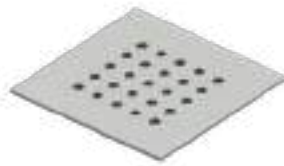

griglia inox per piletta ACA071  
*inox cover for drain ACA071*

La piletta in tinta è disponibile solo  
per le varianti cromatiche riportate  
nella tabella listino qui a lato

*The matching drain is only available  
for the color variations shown in  
the price list chart on the side steel  
finish / ACA072 71*



THE  
SANIGLAZE

piletta universale up & down  
con tappo in ceramica,  
con Saniglaze

*up & down universal drain with  
ceramic cover for washbasins,  
with Saniglaze*



piletta universale  
up & down cromo  
*chrome up & down drain*

tappo in ceramica  
per piletta filettata

*ceramic cover  
for threaded drain*

codice	colore	kg	pz. pallet Italia	pz. pallet Export	euro
--------	--------	----	-------------------------	-------------------------	------

<b>ACA071</b>		0,3	-	-	<b>40</b>
---------------	--	-----	---	---	-----------

<b>ACA072</b>	71	0,6	-	-	<b>60</b>
---------------	----	-----	---	---	-----------

<b>ACA072</b>	05	0,6	-	-	<b>80</b>
---------------	----	-----	---	---	-----------

<b>ACA072</b>	17	0,6	-	-	<b>80</b>
---------------	----	-----	---	---	-----------

<b>ACA072</b>	59	0,6	-	-	<b>80</b>
---------------	----	-----	---	---	-----------

<b>ACA072</b>	60	0,6	-	-	<b>80</b>
---------------	----	-----	---	---	-----------

CLASSIC COLORS

<b>ACA036</b>	01; 34	0,3	-	-	<b>80</b>
---------------	--------	-----	---	---	-----------

<b>ACA038</b>	05; 34	0,3	-	-	<b>90</b>
---------------	--------	-----	---	---	-----------

<b>ACA038</b>	17; 34	0,3	-	-	<b>90</b>
---------------	--------	-----	---	---	-----------

MATT COLORS

<b>ACA038</b>	34	0,3	-	-	<b>90</b>
---------------	----	-----	---	---	-----------

GLOSSY COLORS

<b>ACA038</b>	34	0,3	-	-	<b>90</b>
---------------	----	-----	---	---	-----------

<b>ACA032</b>		0,3	-	-	<b>75</b>
---------------	--	-----	---	---	-----------

CLASSIC COLORS

<b>ACA069</b>	01; 00	0,3	-	-	<b>29</b>
---------------	--------	-----	---	---	-----------

<b>ACA069</b>	05; 00	0,3	-	-	<b>29</b>
---------------	--------	-----	---	---	-----------

<b>ACA069</b>	17; 00	0,3	-	-	<b>29</b>
---------------	--------	-----	---	---	-----------

MATT COLORS

<b>ACA069</b>		0,3	-	-	<b>29</b>
---------------	--	-----	---	---	-----------

GLOSSY COLORS

<b>ACA069</b>		0,3	-	-	<b>29</b>
---------------	--	-----	---	---	-----------



piletta cromo con troppo pieno  
integrato

*chrome drain with integral  
overflow*



THE  
SANIGLAZE

piletta con tappo in ceramica  
e troppo pieno integrato,  
con Saniglaze

*drain with ceramic cover  
and integral overflow,  
with Saniglaze*



schede tecniche  
technical drawing

codice	colore	kg	pz. pallet Italia	pz. pallet Export	euro
--------	--------	----	-------------------------	-------------------------	------

<b>ACA096</b>		0,3	-	-	<b>85</b>
---------------	--	-----	---	---	-----------

CLASSIC COLORS

<b>ACA097</b>	01; 34	0,3	-	-	<b>90</b>
---------------	--------	-----	---	---	-----------

<b>ACA097</b>	05; 34	0,3	-	-	<b>90</b>
---------------	--------	-----	---	---	-----------

<b>ACA097</b>	17; 34	0,3	-	-	<b>90</b>
---------------	--------	-----	---	---	-----------

MATT COLORS

<b>ACA097</b>	34	0,3	-	-	<b>90</b>
---------------	----	-----	---	---	-----------

GLOSSY COLORS

<b>ACA097</b>	34	0,3	-	-	<b>90</b>
---------------	----	-----	---	---	-----------

copriforo troppopieno

*overflow hole cover*



CLASSIC COLORS

<b>ACA105</b>	01; 00	0,05	-	-	<b>5</b>
---------------	--------	------	---	---	----------

<b>ACA105</b>	05; 00	0,05	-	-	<b>5</b>
---------------	--------	------	---	---	----------

<b>ACA105</b>	17; 00	0,05	-	-	<b>5</b>
---------------	--------	------	---	---	----------

MATT COLORS

<b>ACA105</b>		0,05	-	-	<b>5</b>
---------------	--	------	---	---	----------

GLOSSY COLORS

<b>ACA105</b>		0,05	-	-	<b>5</b>
---------------	--	------	---	---	----------

METALS

<b>ACA105</b>		0,05	-	-	<b>5</b>
---------------	--	------	---	---	----------

## ESPOSITORI / DISPLAYS



espositore a "L" per sanitari  
sospesi x2

*"L" display for wall-hung  
sanitaryware x2*

codice	colore	kg	pz. pallet Italia	pz. pallet Export	euro
<b>ACA017</b>		5	-	-	<b>161</b>



espositore a colonna per lavabi

*column display for washbasins*

codice	colore	kg	pz. pallet Italia	pz. pallet Export	euro
<b>ACA019</b>		25	-	-	<b>402</b>



espositore in metallo  
per piatti doccia

*metal display for shower trays*

codice	colore	kg	pz. pallet Italia	pz. pallet Export	euro
<b>033</b>		20	-	-	<b>180</b>

**GENE  
RAL  
INFO**

# CONDIZIONI GENERALI DI VENDITA

## DISPOSIZIONI GENERALI

Le presenti condizioni di vendita e di consegna si intendono integralmente accettate dal Committente con il conferimento dell'ordine o con il ritiro dei materiali. Vengono respinte le eventuali condizioni generali di contratto del Compratore.

## ACCETTAZIONE ORDINI

Gli ordini sono da intendersi subordinati all'accettazione di Artceram.

## PREZZI

I prezzi possono essere variati senza nessun preavviso e si intendono pattuiti secondo i listini in vigore al momento della consegna. I prezzi contenuti nel presente listino sono da intendersi franco fabbrica e IVA esclusa.

## PAGAMENTO

I termini di pagamento si intendono tassativi e decorrono dalla data di fatturazione. I pagamenti devono essere effettuati direttamente ad Artceram presso la sua sede. Hanno effetto liberatorio solo i pagamenti in contanti. Ogni altra forma di pagamento (assegni di c/c, circolari, vaglia, cambiali, tratte, ecc.) resta a completo rischio,w pericolo e spesa del Committente e, ove accettata, salvo buon fine. Qualsiasi ritardo imputabile al Committente o qualsiasi contestazione sorgesse fra le parti, anche relativamente alle garanzie concesse, non produrrá alcun prolungamento o modifica nei termini dei pagamenti convenuti ed ogni azione ed eccezione del Committente non sarà ritenuta procedibile, se lo stesso non proverá di essere in regola coi pagamenti. Nel caso di mora in qualsiasi pagamento potranno essere sospese ed annullate le forniture in corso. Decorso il termine di pagamento stabilito in fattura senza che ne sia avvenuto il regolamento, Artceram avrà la facoltá di emettere tratta a vista per l'ammontare dell'intero credito aumentato delle spese. L'eventuale ritardo nel pagamento comporterá l'addebito di interessi al tasso corrente di mercato, aumentato del 2%. Nel caso di inosservanza di uno dei termini di scadenza anche tutte le altre fatture del venditore saranno immediatamente esigibili. L'esigibilitá di tutte le fatture si verifica anche nell'ipotesi in cui il venditore venga a conoscenza di altre circostanze che lascino temere una cattiva situazione finanziaria del compratore (per esempio: emissione di assegni scoperti, cambiali protestate, procedimenti di sequestro, ecc.).

## TERMINI DI CONSEGNA, RITARDI O IMPEDIMENTI DI FORNITURA

Allorché viene indicato un termine di consegna, questo ha valore semplicemente informativo e non impegnativo, essendo subordinato a qualunque imprevisto. La consegna della merce si intende eseguita con la messa a disposizione della merce presso il nostro stabilimento di Civita Castellana (Italia). Interruzioni di lavoro conseguenti a cause di forza maggiore dispensano Artceram dall'osservare il termine di consegna indicato, senza peraltro dare diritto al Committente di esigere risarcimenti dovuti a danni di qualsiasi natura. La merce dovrà essere sempre ritirata dal Committente e non dovrà essere in ogni caso lasciata giacente. Le eventuali spese di giacenza, magazzinoaggio, ecc. saranno comunque a carico del Committente.

## TRASPORTO

Salve condizioni particolari, la merce é venduta franco nostro stabilimento ed in ogni caso viaggia a rischio e pericolo del Committente anche se resa franco destino. Sono consentite forniture parziali e anticipate. Il trasporto é a carico del Committente. Le spedizioni avvengono per conto ed incarico del Committente, il quale, in caso di avarie, rotture o ammanchi, deve notificarlo alla nostra azienda, tramite il vettore, al momento della consegna. La merce consegnata rimane di riservato dominio della venditrice fino all'avvenuto pagamento. I termini di consegna si intendono sempre indicativi ed in relazione alle possibilitá del momento. Non si assume nessuna responsabilitá per ritardi o mancate consegne per fatti o atti indipendenti dalla nostra volontà ed eventuali richieste di risarcimento danni per ritardi di consegna non saranno accettati.

## IMBALLAGGIO

L'imballaggio viene effettuato in pallets e retraibile. Il costo dell'imballaggio é a carico del Committente, salvo patto contrario risultante dalla conferma d'ordine. A parziale recupero delle spese di imballo viene addebitato il 3%.

## GARANZIA

Garanzia di 2 anni dalla data di acquisto, secondo i Termini Generali di Vendita. Non valida in caso di installazione non corretta.

## RESPONSABILITÀ

Artceram non dá garanzie circa l'impiego errato o inadatto della merce fornita e pertanto nessuna responsabilitá potrà essere attribuita a qualsiasi titolo e nessun indennizzo potrà essere richiesto. Qualora il materiale risultasse difettoso per vizi di fabbricazione riconosciuti a seguito di accertamenti tecnici. Artceram si riserva di sostituirlo o di accreditare il valore qualora piú conveniente procedere alla sua distruzione in loco. In nessun caso la responsabilitá di Artceram puó estendersi ai danni diretti e indiretti che dovessero derivare dalla posa in opera del materiale difettoso.

## RECLAMI

Non si accettano reclami di nessun genere trascorsi otto giorni dal ricevimento della marce. Eventuali reclami dovranno essere fatti a mezzo lettera raccomandata entro tale termine. In ogni caso nessuna contestazione verrà accettata per materiali già posti in opera.

## CARATTERISTICHE TECNICHE E COLORI

Artceram si riserva la facoltá di modificare le caratteristiche al fine di migliorare tecnicamente ed esteticamente il prodotto o sospendere la produzione dei modelli in qualsiasi momento senza preavviso. Pesi e misure sono da considerarsi indicativi. Le misure di installazione, riportate nei cataloghi, possono presentare differenze rispetto ai pezzi reali in considerazione delle peculiari caratteristiche di fabbricazione degli articoli in ceramica.

## FORO COMPETENTE

Qualsiasi controversia fra Artceram e il Committente sarà di competenza soltanto del Foro di Viterbo (Italia), esclusa qualsiasi altra deroga, anche nel caso di chiamata in giudizio per garanzia, connessione, contingenza di lite.

# GENERAL SALES CONDITIONS

## GENERAL CONDITIONS

*The present conditions of sale and delivery are considered as fully accepted by the Purchaser upon the order or the collection of the goods. Any general conditions of sale of the Purchaser are rejected.*

## ACCEPTANCE OF ORDERS

*The orders are anyway subject to the prior consent of Artceram.*

## PRICES

*Prices may be charged without notice and are agreed according to the price list in force on delivery. The prices of the present price list are meant ex factory and don't include V.A.T.*

## PAYMENT

*Payment terms must be strictly respected starting from the invoice date. Payments should be made directly to Artceram at its headquarter. Only cash payment will free from the debt. Any other form of payment (current account cheques, bank draft, money orders, bills, draft and so on) is accepted under reserve and remains at the Purchaser's risk, peril and expenses. Any delay caused by the Purchaser or should any dispute arise between the parties as to the guarantees granted will not result in an extension or change of the terms of payment agreed upon and any Purchaser's action and exception will not be considered as prosecutable if the Purchaser does not prove to be up-to-date with his payments. In case of delay in any payment the supplies under way may be interrupted or cancelled. If no payments has been received within the terms set up in the invoice, Artceram will be authorized to issue a sight draft for the total amount of its credit plus the relevant expenses. Any possible delay in the payment will result in the charge of interest at the market current rate plus 2%. In case of failure to meet one of the payment dates the seller will be entitled to demand immediate payment of all other invoices. Payment of all the invoices may also be demanded if the seller receives information about others circumstances which may indicate that the purchaser's financial situation is not sound (for example: issue of bouncing cheques, protested bills of exchange, attached proceeding).*

## DELIVERY TERMS, DELAYS OR OBSTACLES IN SUPPLY

*When a delivery terms is stated, such term is given only for information purpose and is not binding since it is subject to any kind of contingency. Delivery is considered as being completed when the goods are available at our factory in Civita Castellana (Italy). Work stoppage resulting from act of God will exempt Artceram from the observance of the delivery term stated without giving the Purchaser the right to claim for any kind of damages. The goods shall always be collected and shall not remain in stock for any reason. Any stock or storage expenses or other costs will be charged to the Customer.*

## CARRIAGE

*Except for particular condition, goods are delivered ex factory and travel at Purchaser's risk even when they are delivered free port of destination. Partial supplies and early supply are permitted. The cost of transport is at Customer charge. Shipment are made on behalf of the buyer. In case of damages, breakages and shortages, the buyer has to notify to our firm through the carrier at the moment of the delivery. The supplier is the owner of the delivered goods up to the due payment. Terms of delivery are subject to variations and depending to the possibilities of the moment. Our firm is not responsible for any delay or missing deliveries caused by any facts independent of our will and any claim for reimbursement for any delay that may occur in delivery will not be accepted.*

## PACKAGING

*The packaging is made in pallets and shrink. The cost of the packaging is charged to the Purchaser, unless otherwise agreed upon as specified in the order confirmation. We charge of 3% for freights of packaging.*

## WARRANTY

*2-year warranty from the date of purchase, in accordance with the General Terms of Sale. Not valid in case of improper installation.*

## LIABILITY

*Artceram gives no guarantee against the improper or wrong use of the goods supplied, consequently no liability may be imputed to it for any reason and no damages may be claimed for. Should the material be supplied turn out to the be foulty for manufacturing defects being acknowledged after technical checks, Artceram reserves the right to replace it or to credit its value if the destruction on site of the goods is deemed to be more convenient. The liability of Artceram can in no case be extended to the direct and consequential damages which could result from the installation of faulty material.*

## COMPLAINS

*No complain of any kind will be accepted after eight days from the receipt of the goods. Possible complains should be made through a registered letter within such term. In any case no objection will be accepted for already installed material.*

## TECHNICAL FEATURES AND COLORS

*Artceram reserves the right to change the features of its products in order to improve them from the technical and aesthetic viewpoint or to interrupt the production of certain models in any time without notice. Weight and measures are given only for information purposes. Discrepancies may be found between the dimensions shown in the catalogues and the real pieces because of the manufacturing characteristics of the articles in ceramic.*

## COMPETENT COURT

*Any dispute between Artceram and the Purchaser will be settled only by the Court of Viterbo (Italy), with no exception to such rule, even in case of summons for guarantee, consolidation of actions or lawsuit contingency.*

# MATERIALI CARATTERISTICHE E MANUTENZIONE

## LIVINGTEC

### **CARATTERISTICHE, USO E MANUTENZIONE**

È prodotto con un materiale compatto la sua composizione è a base idrato di allumina e una bassa percentuale di resina poliestere acrilica materiale piacevole al tatto, la sua omogeneità e brillantezza, il nero la raggiunge totalmente grazie ad un trattamento a spruzzo, prodotto da trattare con cura ed attenzione.

### **CONSIGLI PER LA PULIZIA**

Lavare la superficie dei lavabi esclusivamente con prodotti neutri liquidi. Per riassicquare e asciugare usare: spugne non abrasive, panni morbidi o pelle di "daino".

### **COSE DA NON USARE**

Pagliette d'acciaio, prodotti anticalcare e prodotti contenenti acidi.

**TUTTI GLI ARTICOLI IN CATALOGO SONO IN FINITURA LUCIDA**

## LEGNO

### **LAVORAZIONI E ACCESSORI**

- lavorazioni effettuate con macchinari a controllo numerico
- finitura trasparente effettuata con vernice acrilica provvista di certificazioni che ne attestano la resistenza all'umidità
- staffe per mensole in metallo laccato grigio
- ferramenta Wurth

# MATERIALS CHARACTERISTICS & MAINTENANCE

## LIVINGTEC

### **CHARACTERISTICS, USE AND MAINTENANCE**

*The livingtec is a compact, not porous material. Its composition is based on hydrate of alumina and a small percentage of resins polyester acrylic, a material pleasant to the touch. This material is so uniform and bright thanks to a spray-treatment. Please, take care and attention.*

### **CLEANING ADVICES**

*Wash the surface only with fluid neutral products; to remove soap and dry, use only not-pot scourers, soft clothes or deerskin.*

### **DON'T USE FOR CLEANING**

*Wire wool, anti-limestone products and acid products.*

**ALL PRODUCTS IN CATALOGUE ARE IN GLOSS FINISH**

## WOOD

### **MANUFACTURING AND ACCESSORIES**

- work done with CNC machines
- transparent finish made with acrylic paint provided with certifications that attest the resistance to moisture
- brackets for shelves in lacquered metal gray
- Wurth hardware

**CREDITS:**

**Art Direction by Meneghello Paoelli**

**Design by Meneghello Paoelli**

A16 | Atelier | Babila | Bold | Brera | Brooklyn | Church | Civitas | Cognac & Cognac Quadro | File 2.0 | Fuori Scala | Ghost | Jolie | La Ciotola | La Fontana 2.0 | Lavamani | Lord | Milano | Mono | Monet | Opera | Passepartout | Petite | Rodolfo | Rombo & Millerighe | Scalino | Seta | Solida | Ten | Vita | Whisky | Won

**Design by Pozzebon**

Relax

**Catalogue Design Graphic Garden by Eliana Dedda**

**Photo Roberto Costantini**

**Rendering Render Delight Studio, Salaposa Studio e Imago Design**

**SPECIAL THANKS TO:**

**Fima Carlo Frattini www.fimacf.com**

**Nobili www.nobili.it**

**Rubinerie Stella www.rubinetteriestella.it**

**Cesana www.cesana.it**

**Luceplan www.luceplan.com**

**Kdln kdln.it**

