

20

the.artceram

NEWSBOOK 2025



25

the.artceram

«TUTTE LE GRANDI BAND
DEGLI ANNI '60
INIZIANO COL "THE"»

«*ALL THE GOOD
60'S BANDS STARTED
WITH A "THE"»*

(THE COMMITMENTS, RODDY DOYLE, 1987)



4 **BROOKLYN**
washbasins & structures collection

50 **PASSEPARTOUT**
ceramic shelf



60 **MAGICLIGHT**
ultraviolet germicidal irradiation device

20 **WONDER**
washbasins collection



30 **WHISKY**
washbasins collection

38 **RODOLFO**
washbasins collection



70 **FILE 2.0**
new wc seat

COLLECTION
UPDATE



76 **AQUANIT**
shower trays collection

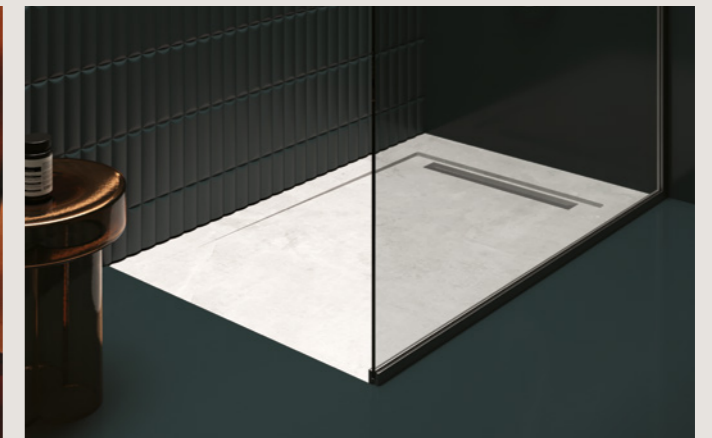

INDEX

INDEX



BROOKLYN

Washbasins & Structures Collection

Brooklyn è una collezione a bordo fino non convenzionale, che si pone a metà strada tra un lavabo d'appoggio e una consolle, incorporando le diverse caratteristiche di entrambi i prodotti; Quattro lavabi dalle linee moderne e morbide, progettati per soddisfare le necessità di chi desidera un prodotto elegante, contemporaneo ed estremamente funzionale. Ogni lavabo incorpora una "fascia" integrata nella ceramica che ha la duplice funzione di piano d'appoggio ed eventuale supporto al rubinetto. Questo elemento divide e collega il perimetro del lavabo in due zone distinte: una zona umida (il lavabo stesso) ed una zona secca, una "tasca" che diventa un'opportunità per circoscrivere un'area di contenimento e diventare supporto per degli accessori. La parte piana - posteriore o laterale, a seconda delle dimensioni del lavabo scelto - diventa quindi il punto di congiunzione tra questi due spazi, unendo estetica e praticità in un ottimo equilibrio.

Brooklyn is an unconventional collection with thin edges, positioned halfway between a countertop sink and a console, incorporating various features of both products. It consists of four sinks with modern, soft lines, designed to meet the needs of those seeking an elegant, contemporary, and highly functional product. Each sink features an integrated "band" in the ceramic that serves a dual purpose as a countertop and potential faucet support. This element divides and connects the perimeter of the sink into two distinct areas: a wet area (the sink itself) and a dry area, a "pocket" that provides an opportunity for storage and can support accessories. The flat part - either at the back or side, depending on the chosen sink size - thus becomes the junction between these two spaces, blending aesthetics and practicality in perfect balance.



Collezione Brooklyn
Collection Brooklyn

archiproducts
AWARDS
WINNER





ACS016 17

BNL002 01

BNL002 01

ACA092

BROOKLYN

BROOKLYN



ACS016 17

BNL002 01

ACA092

BROOKLYN





ACS018 01

BNL001 01



ACS019 01

BNL002 01

ACM044



BROOKLYN FAUCET PLACEMENT

Offriamo la massima personalizzazione del prodotto! Con i lavabi Brooklyn, il cliente finale può scegliere se installare una rubinetteria classica monoforo, due fori o tre, o anche a muro; sia a DX che SX, in base alle proprie preferenze! Tutti i lavabi presentano fori 'preforati': la fascia di ceramica è piena e smaltata sulla parte superiore, mentre sul retro non smaltato sono segnati i fori, che potranno essere aperti da un installatore professionista per garantire fori precisi.

We offer the highest level of product customization! With the Brooklyn sinks, the end customer can choose to install a classic single-hole, two-hole, or three-hole faucet, or even wall-mounted, either on the right or left, according to their preferences! All sinks feature 'preforated' holes: the ceramic rim is solid and glazed on the top, while on the unglazed back, the holes are marked, and can be opened by a professional installer to ensure precise holes.

BROOKLYN 100 (BNL001)

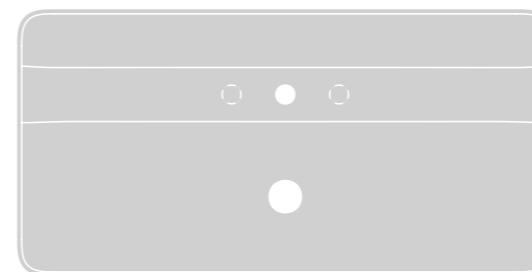

BROOKLYN 90 (BNL002)



BROOKLYN 65 (BNL003)



BROOKLYN 60 (BNL004)



BROOKLYN VARIATIONS

colori e finiture - colors and finishes...

CLASSIC COLORS



bianco lucido / glossy white

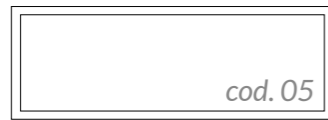

bianco matt / matt white



nero matt / matt black

MATT COLORS



grigio oliva / grey olive



blu avio / blue avio



verde foresta / green foresta



verde salvia / green salvia



marrone tortora / brown tortora



marrone matera / brown matera



ghiaia / gravel



sabbia / sand

GLOSSY COLORS



rosè / rosè



biscotto / biscuit



cotone / cotton



lichene / lichen

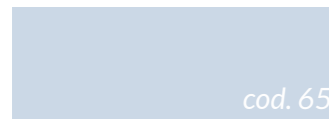

celeste / pale blue

METALS



nero matt / matt black

*Unico colore disponibile per le barre porta asciugamani Brooklyn
Only colour available for Brooklyn towel rails

STORAGE



moka / moka

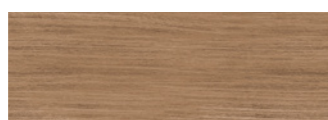

noce canaletto / canaletto walnut

*Unica combinazione colore disponibile per la struttura Brooklyn
Only colour combination available for the Brooklyn structure

BROOKLYN OVERVIEW



THE.SANI GLAZE

BROOKLYN 100 | 100 x 50

lavabo sospeso/appoggio
1 foro (predisposto 3 fori)

wall-hung/countertop
washbasin 1 hole with
arrangements for 3 holes



schede tecniche
technical drawing

codice	colore	kg	pz. pallet Italia	pz. pallet Export	euro	
CLASSIC COLORS						
BNL001	01	34	33,5	10	20	665
BNL001	05	34	33,5	10	20	1060
BNL001	17	34	33,5	10	20	1060
MATT COLORS						
BNL001		34	33,5	10	20	1060
GLOSSY COLORS						
BNL001		34	33,5	10	20	1060

coppia staffe per Brooklyn 100
obbligatorie per fissaggio lavabo
sospeso

ACA087 - - - **135**

fitting system kit for Brooklyn 100
compulsory for fixing wall-hung
washbasin

portasciugamani
per lavabo Brooklyn 100

ACA091 ● 5 - - **380**

towel rail for washbasin
Brooklyn 100

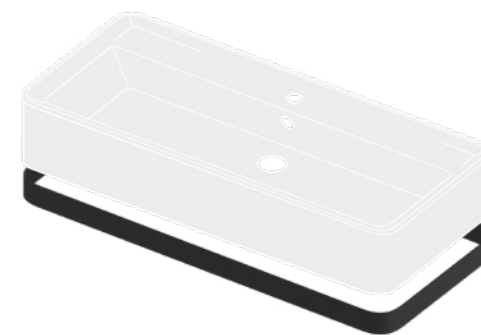



THE.SANIGLAZE

BROOKLYN 90 | 90 x 40

lavabo rettangolare appoggio/
sospeso/per struttura dedicata
senza foro (predisposto 3 fori)

*rectangular countertop/wall-
hung/for structure washbasin no
hole with arrangements
for 3 holes*



schede tecniche
technical drawing

codice	colore	kg	pz. pallet Italia	pz. pallet Export	euro
CLASSIC COLORS					
BNL002	○ 01; 34	24	12	24	620
BNL002	◎ 05; 34	24	12	24	1000
BNL002	● 17; 34	24	12	24	1000
MATT COLORS					
BNL002		34	24	12	24 1000
GLOSSY COLORS					
BNL002		34	24	12	24 1000



coppia staffe per Brooklyn 90/65
obbligatorie per fissaggio lavabo
sospeso

*fitting system kit for Brooklyn
90/65 compulsory for fixing
wall-hung washbasin*

struttura per lavabo Brooklyn 90
in massello noce canaletto
con cassettone integrato
laccato color moka matt

*structure for washbasin Brooklyn
90 in solid Canaletto walnut
with integrated drawer
lacquered in matt moka color*



schede tecniche
technical drawing

ACA089		-	-	-	130
---------------	--	---	---	---	------------

ACM044		25	-	-	3250
---------------	--	----	---	---	-------------

ACA092	●	3.7	-	-	340
---------------	---	-----	---	---	------------

portasciugamani
per lavabo Brooklyn 90

*towel rail for washbasin
Brooklyn 90*

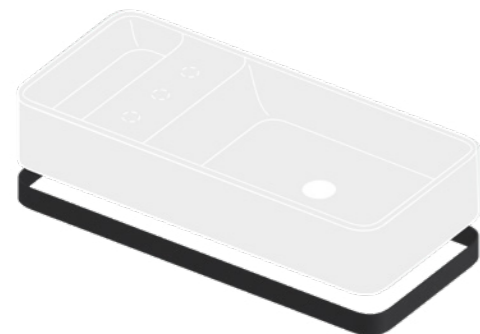

THE.SANIGLAZE

BROOKLYN 65 | 65 x 40

lavabo rettangolare appoggio/
sospeso/per struttura dedicata
senza foro (predisposto 3 fori)

*rectangular countertop/wall-
hung/for structure washbasin no
hole with arrangements
for 3 holes*



schede tecniche
technical drawing

codice	colore	kg	pz. pallet Italia	pz. pallet Export	euro
CLASSIC COLORS					
BNL003	○ 01; 34	19	20	33	570
BNL003	◎ 05; 34	19	20	33	910
BNL003	● 17; 34	19	20	33	910
MATT COLORS					
BNL003		34	19	20	33 910
GLOSSY COLORS					
BNL003		34	19	20	33 910



coppia staffe per Brooklyn 90/65
obbligatorie per fissaggio lavabo
sospeso

*fitting system kit for Brooklyn
90/65 compulsory for fixing
wall-hung washbasin*

struttura per lavabo Brooklyn 65
in massello noce canaletto
con cassettone integrato
laccato color moka matt

*structure for washbasin Brooklyn
65 in solid Canaletto walnut
with integrated drawer
lacquered in matt moka color*



schede tecniche
technical drawing

ACA089		-	-	-	130
---------------	--	---	---	---	------------

ACM043		20	-	-	3050
---------------	--	----	---	---	-------------

ACA093	●	3	-	-	260
---------------	---	---	---	---	------------

portasciugamani
per lavabo Brooklyn 65

*towel rail for washbasin
Brooklyn 65*

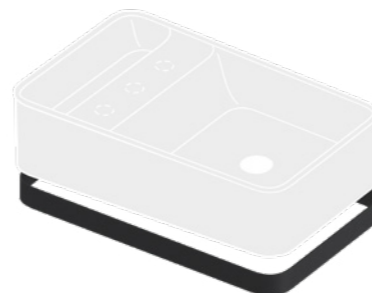



THE.SANI GLAZE

BROOKLYN 60 | 60 x 35 h25

lavabo rettangolare appoggio/
sospeso senza foro (predisposto
1 foro)

*rectangular countertop/wall-
hung washbasin no hole with
arrangements for 1 hole*



schede tecniche
technical drawing

codice	colore	kg	pz. pallet Italia	pz. pallet Export	euro
CLASSIC COLORS					
BNL004	○ 01; 34	21	16	32	525
BNL004	◎ 05; 34	21	16	32	850
BNL004	● 17; 34	21	16	32	850
MATT COLORS					
BNL004		34	21	16	32 850
GLOSSY COLORS					
BNL004		34	21	16	32 850

coppia staffe per Brooklyn 60
obbligatorie per fissaggio lavabo
sospeso

*fitting system kit for Brooklyn 60
compulsory for fixing wall-hung
washbasin*

ACA090		-	-	-	130
---------------	--	---	---	---	------------

	codice	colore	kg	pz. pallet Italia	pz. pallet Export	euro
CLASSIC COLORS						
piletta universale lavabo up & down tappo in ceramica	ACA036	○ 01; 34	0,3	-	-	75
<i>up & down universal drain with ceramic cover for washbasins</i>	ACA038	◎ 05; 34	0,3	-	-	81
	ACA038	● 17; 34	0,3	-	-	81
MATT COLORS						
	ACA038		34	0,3	-	- 81
GLOSSY COLORS						
	ACA038		34	0,3	-	- 81

piletta universale lavabo up & down cromo	ACA032		0,3	-	-	69
<i>chrome up & down drain for washbasin</i>						

piletta universale Pop con troppopieno integrato	ACA061	71	0,5	-	-	173
	ACA061	◎ 05; 34	0,5	-	-	196
<i>Pop universal drain with integral overflow</i>	ACA061	● 17; 34	0,5	-	-	196

sifone cilindrico cromo <i>chrome siphon</i>	ACA022		1	-	-	109
---	---------------	--	---	---	---	------------

sifone cilindrico - <i>siphon</i>	ACA099	◎ 05	1	-	-	109
	ACA099	● 17	1	-	-	109

WONDER

Washbasins Collection

La collezione Wonder rappresenta un nuovo capitolo nell'evoluzione del design del lavabo, Ispirata al profilo "bold" che ha reso celebre la premiata collezione Brera.

Se quest'ultima ha segnato un'innovazione audace, introducendo profili generosi e marcati nella ceramica, Wonder ne interpreta il linguaggio con una delicatezza tutta sua, per un design più fluido ma comunque iconico. Il profilo "bold" scende così dritto e deciso, ma senza mai diventare un "bordo", fondendosi perfettamente con la superficie del lavabo, creando un effetto armonioso e contemporaneo. L'elemento decorativo, che in Brera era protagonista, qui si fa più discreto, sussurrato, eppure altrettanto distintivo. Con Wonder, The.Artceram continua a sorprendere, rinnovando il linguaggio della ceramica e portando la bellezza del design a nuovi livelli di raffinatezza. Un perfetto equilibrio tra audacia e eleganza che trasforma il lavabo in un elemento non solo funzionale, ma anche iconico, capace di donare carattere e stile a ogni bagno.

The Wonder collection represents a new chapter in the evolution of sink design, inspired by the "bold" profile that made the award-winning Brera collection famous. While the latter marked a bold innovation by introducing generous and defined profiles in ceramics, Wonder reinterprets this language with its own delicate touch, offering a design that is fluid yet still iconic. The "bold" profile drops straight and determined, but never turns into a "border," blending seamlessly with the sink surface to create a harmonious and contemporary effect. The decorative element, which was the main feature in Brera, here becomes more subtle, whispered, yet equally distinctive. With Wonder, The.Artceram continues to amaze by renewing the language of ceramics and bringing the beauty of design to new levels of refinement. A perfect balance between audacity and elegance, transforming the sink into not just a functional element, but also an iconic one, capable of adding character and style to any bathroom.



Collezione Wonder
Collection Wonder





WNL002 01



WNL001 01



WONDER VARIATIONS

colori e finiture - colors and finishes...

CLASSIC COLORS



bianco lucido / glossy white



nero lucido / glossy black

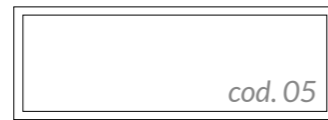

bianco matt / matt white



nero matt / matt black

MATT COLORS



grigio oliva / grey olive



blu avio / blue avio



verde foresta / green foresta



verde salvia / green salvia



marrone tortora / brown tortora



marrone matera / brown matera



ghiaia / gravel



sabbia / sand

GLOSSY COLORS



rosè / rosè



biscotto / biscuit

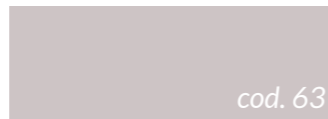

cotone / cotton

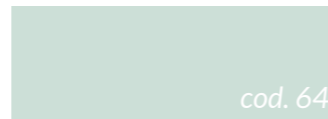

lichene / lichen



celeste / pale blue

WONDER OVERVIEW



THE.SANIGLAZE

WONDER | 55 x 37

lavabo appoggio senza foro
rubinetto

countertop washbasin
without tap hole



schede tecniche
technical drawing

codice	colore	kg	pz. pallet Italia	pz. pallet Export	euro
CLASSIC COLORS					
WNL001	01; 34	-	-	-	360
WNL001	03; 34	-	-	-	610
WNL001	05; 34	-	-	-	610
WNL001	17; 34	-	-	-	610
MATT COLORS					
WNL001	34	-	-	-	610
GLOSSY COLORS					
WNL001	34	-	-	-	610



THE.SANIGLAZE

WONDER | Ø 44

lavabo appoggio senza foro
rubinetto

countertop washbasin
without tap hole



schede tecniche
technical drawing

codice	colore	kg	pz. pallet Italia	pz. pallet Export	euro
CLASSIC COLORS					
WNL002	01; 34	-	-	-	350
WNL002	03; 34	-	-	-	600
WNL002	05; 34	-	-	-	600
WNL002	17; 34	-	-	-	600
MATT COLORS					
WNL002	34	-	-	-	600
GLOSSY COLORS					
WNL002	34	-	-	-	600

* i prodotti Wonder sono disponibili da Giugno
Wonder is available from June



THE.SANI GLAZE

WONDER | 55 x 43

lavabo sospeso/appoggio con foro rubinetto

wall-hung/countertop washbasin with tap hole



schede tecniche
technical drawing

codice	colore	kg	pz. pallet Italia	pz. pallet Export	euro
CLASSIC COLORS					
WNL003	○ 01; 34	-	-	-	370
WNL003	● 03; 34	-	-	-	630
WNL003	◎ 05; 34	-	-	-	630
WNL003	◎ 17; 34	-	-	-	630
MATT COLORS					
WNL003	34	-	-	-	630
GLOSSY COLORS					
WNL003	34	-	-	-	630



THE.SANI GLAZE

WONDER | 48 x 45

lavabo sospeso/appoggio con foro rubinetto dx/sx

wall-hung/countertop washbasin with tap hole right/left



schede tecniche
technical drawing

codice	colore	kg	pz. pallet Italia	pz. pallet Export	euro
CLASSIC COLORS					
WNL004	○ 01; 34	-	-	-	360
WNL004	● 03; 34	-	-	-	610
WNL004	◎ 05; 34	-	-	-	610
WNL004	◎ 17; 34	-	-	-	610
MATT COLORS					
WNL004	34	-	-	-	610
GLOSSY COLORS					
WNL004	34	-	-	-	610

* i prodotti Wonder sono disponibili da Giugno
Wonder is available from June

	codice	colore	kg	pz. pallet Italia	pz. pallet Export	euro
tasselli per fissaggio lavabi sospesi	ACA007		0,3	-	-	12
<i>fitting system kit for wall-hung washbasins</i>						
* fissaggi non inclusi nel prezzo <i>fitting system kit not included in the price</i>						
<hr/>						
piletta cromo con troppo pieno integrato	ACA096		0,3	-	-	75
<i>chrome drain with integral overflow</i>						
<hr/>						
piletta con tappo in ceramica e troppo pieno integrato						
CLASSIC COLORS						
	ACA097	○ 01; 34	0,3	-	-	85
	ACA097	● 03; 34	0,3	-	-	85
	ACA097	◎ 05; 34	0,3	-	-	85
	ACA097	◎ 17; 34	0,3	-	-	85
<i>drain with ceramic cover and integral overflow</i>						
MATT COLORS						
	ACA097	34	0,3	-	-	85
GLOSSY COLORS						
	ACA097	34	0,3	-	-	85
<hr/>						
sifone cilindrico cromo <i>chrome siphon</i>	ACA022		1	-	-	109
<hr/>						
sifone cilindrico - <i>siphon</i>	ACA099	◎ 05	1	-	-	109
	ACA099	◎ 17	1	-	-	109

WHISKY

Washbasins Collection

I lavabi da appoggio della collezione Whisky rappresentano una funzionale e raffinata evoluzione dei lavabi a bordo fino Cognac. Ispirati alle forme generose e tondeggianti dei celebri bicchieri da degustazione, questi lavabi in ceramica si distinguono per il loro equilibrio tra un'estetica contemporanea e un ottimo grado di funzionalità, che permette di alloggiare la rubinetteria. Le linee morbide e avvolgenti dei lavabi evocano un senso di lusso discreto, mentre la superficie ceramica, trattata con tecniche avanzate, garantisce una lunga durata nel tempo e una facile manutenzione. Ogni pezzo della collezione è il risultato di un'attenta lavorazione artigianale, dove la tradizione si fonde con l'innovazione per offrire un prodotto unico e distintivo.

The countertop basins of the Whisky collection represent a functional and refined evolution of the Cognac thin-edged basins.

Inspired by the generous and rounded shapes of the famous tasting glasses, these ceramic basins stand out for their balance between contemporary aesthetics and a high degree of functionality, allowing for the integration of faucets. The soft and enveloping lines of the basins evoke a sense of discreet luxury, while the ceramic surface, treated with advanced techniques, ensures long-lasting durability and easy maintenance. Each piece in the collection is the result of meticulous craftsmanship, where tradition merges with innovation to offer a unique and distinctive product.



Collezione Whisky
Collection Whisky



WHL001 01

WHL002 01



ACS016 17



WHL002 01



WHL001 01



WHISKY VARIATIONS

colori e finiture - *colors and finishes...*

CLASSIC COLORS



bianco lucido / *glossy white*



nero lucido / *glossy black*

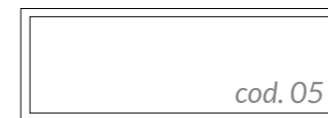

bianco matt / *matt white*



nero matt / *matt black*

MATT COLORS



grigio oliva / *grey olive*



blu avio / *blue avio*



verde foresta / *green foresta*



verde salvia / *green salvia*



marrone tortora / *brown tortora*



marrone matera / *brown matera*



ghiaia / *gravel*



sabbia / *sand*

GLOSSY COLORS



rosè / *rosè*



biscotto / *biscuit*



cotone / *cotton*



lichene / *lichen*

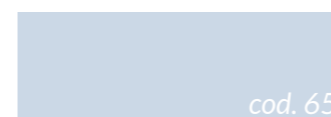

celeste / *pale blue*

WHISKY OVERVIEW



THE.SANIGLAZE

WHISKY 45 | 45 x 45

lavabo appoggio
countertop washbasin



schede tecniche
technical drawing

codice	colore	kg	pz. pallet Italia	pz. pallet Export	euro
CLASSIC COLORS					
WHL001	01; 34	11,5	24	48	330
WHL001	03; 34	11,5	24	48	550
WHL001	05; 34	11,5	24	48	550
WHL001	17; 34	11,5	24	48	550
MATT COLORS					
WHL001	34	11,5	24	48	550
GLOSSY COLORS					
WHL001	34	11,5	24	48	550



THE.SANIGLAZE

WHISKY 53 | 53 x 42

lavabo appoggio
countertop washbasin



schede tecniche
technical drawing

codice	colore	kg	pz. pallet Italia	pz. pallet Export	euro
CLASSIC COLORS					
WHL003	01; 34	12,5	20	40	350
WHL003	03; 34	12,5	20	40	590
WHL003	05; 34	12,5	20	40	590
WHL003	17; 34	12,5	20	40	590
MATT COLORS					
WHL003	34	12,5	20	40	590
GLOSSY COLORS					
WHL003	34	12,5	20	40	590



THE.SANIGLAZE

WHISKY 60 | 60 x 45

lavabo appoggio
countertop washbasin



schede tecniche
technical drawing

codice	colore	kg	pz. pallet Italia	pz. pallet Export	euro
CLASSIC COLORS					
WHL002	01; 34	13,5	20	40	370
WHL002	03; 34	13,5	20	40	620
WHL002	05; 34	13,5	20	40	620
WHL002	17; 34	13,5	20	40	620
MATT COLORS					
WHL002	34	13,5	20	40	620
GLOSSY COLORS					
WHL002	34	13,5	20	40	620

piletta universale lavabo
up & down tappo in ceramica

up & down universal drain
with ceramic cover
for washbasins

codice	colore	kg	pz. pallet Italia	pz. pallet Export	euro
CLASSIC COLORS					
ACA036	01; 34	0,3	-	-	75
ACA038	03; 34	0,3	-	-	81
ACA038	05; 34	0,3	-	-	81
ACA038	17; 34	0,3	-	-	81
MATT COLORS					
ACA038	34	0,3	-	-	81
GLOSSY COLORS					
ACA038	34	0,3	-	-	81

piletta universale lavabo
up & down cromo

chrome up & down drain
for washbasin

codice	colore	kg	pz. pallet Italia	pz. pallet Export	euro
ACA032		0,3	-	-	69

piletta universale Pop
con troppopieno integrato

Pop universal drain
with integral overflow

codice	colore	kg	pz. pallet Italia	pz. pallet Export	euro
ACA061	71	0,5	-	-	173
ACA061	05; 34	0,5	-	-	196
ACA061	17; 34	0,5	-	-	196

RODOLFO

Washbasins Collection

La collezione Rodolfo definisce una collezione di lavabi "quadrati" caratterizzati dal loro bordo distintivo e per la loro flessibilità di utilizzo. I lavabi, disponibili nelle dimensioni 80x45, 65x45, 50x45 e 40x38 cm, sono progettati per offrire versatilità e stile senza compromessi; sono stati pensati per ambienti ad "alto traffico", dove durabilità, funzionalità e design estetico sono essenziali! I lavabi Rodolfo hanno forme compatte e ortogonali, arricchiti da angoli arrotondati e spessori rilevanti. Un dettaglio distintivo della collezione è l'inclinazione a 45° dei bordi che scendono delicatamente nella vasca, elemento chiave che crea un armonioso fil-rouge tra tutti i modelli. Questo particolare si fonde elegantemente nella zona di appoggio che ospita la rubinetteria e che offre anche uno spazio pratico e funzionale per posizionare accessori di uso quotidiano. Tale caratteristica rende i lavabi Rodolfo estremamente versatili e adatti a qualsiasi esigenza di spazio.

The Rodolfo collection defines a series of "square" basins characterized by their distinctive edge and flexibility of use. The basins, available in sizes 80x45, 65x45, 50x45, and 40x38 cm, are designed to offer versatility and style without compromise; they are intended for high-traffic environments where durability, functionality, and aesthetic design are essential! The Rodolfo basins feature compact and orthogonal shapes, enhanced by rounded corners and significant thicknesses. A distinctive detail of the collection is the 45° inclination of the edges that gently slope into the basin, a key element that creates a harmonious fil-rouge among all models. This detail elegantly blends into the countertop area that houses the faucet and also provides a practical and functional space for placing everyday accessories. This feature makes the Rodolfo basins extremely versatile and suitable for any space requirement.



Collezione Rodolfo
Collection Rodolfo



ROL00101

ROL00401

ROL00301

ROL00201





ACS01801



ROL00101



ROL00601



ACS018 01

ROL005 01



RODOLFO VARIATIONS

colori e finiture - colors and finishes...

CLASSIC COLORS



cod. 01

bianco lucido / glossy white

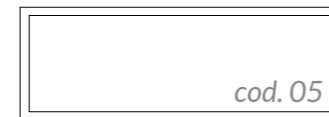

cod. 05

bianco matt / matt white



cod. 17

nero matt / matt black

RODOLFO OVERVIEW



THE.SANIGLAZE

RODOLFO 40 | 40 x 38

lavabo sospeso/appoggio
1 foro

wall-hung/countertop
washbasin 1 hole



schede tecniche
technical drawing

codice	colore	kg	pz. pallet Italia	pz. pallet Export	euro
CLASSIC COLORS					
ROL004	○ 01; 34	12	28	52	305
ROL004	◎ 05; 34	12	28	52	475
ROL004	● 17; 34	12	28	52	475



THE.SANIGLAZE

RODOLFO 65 | 65 x 45

lavabo sospeso/appoggio
1 foro (predisposto 3 fori)

wall-hung/countertop
washbasin 1 hole with
arrangements for 3 holes



schede tecniche
technical drawing

codice	colore	kg	pz. pallet Italia	pz. pallet Export	euro
CLASSIC COLORS					
ROL002	○ 01; 34	19,5	20	33	400
ROL002	◎ 05; 34	19,5	20	33	620
ROL002	● 17; 34	19,5	20	33	620



THE.SANIGLAZE

RODOLFO 50 | 50 x 45

lavabo sospeso/appoggio
1 foro (predisposto 3 fori)

wall-hung/countertop
washbasin 1 hole with
arrangements for 3 holes



schede tecniche
technical drawing

codice	colore	kg	pz. pallet Italia	pz. pallet Export	euro
CLASSIC COLORS					
ROL003	○ 01; 34	16,5	24	48	330
ROL003	◎ 05; 34	16,5	24	48	525
ROL003	● 17; 34	16,5	24	48	525



THE.SANIGLAZE

RODOLFO 80 | 80 x 45

lavabo sospeso/appoggio
1 foro (predisposto 3 fori)

wall-hung/countertop
washbasin 1 hole with
arrangements for 3 holes



schede tecniche
technical drawing

codice	colore	kg	pz. pallet Italia	pz. pallet Export	euro
CLASSIC COLORS					
ROL001	○ 01; 34	21,5	14	28	460
ROL001	◎ 05; 34	21,5	14	28	720
ROL001	● 17; 34	21,5	14	28	720



THE.SANIGLAZE

RODOLFO 100 | 100 x 45

lavabo sospeso/appoggio
1 foro (predisposto 3 fori)

wall-hung/countertop
washbasin 1 hole with
arrangements for 3 holes



schede tecniche
technical drawing

codice	colore	kg	pz. pallet Italia	pz. pallet Export	euro
CLASSIC COLORS					
ROL005	○ 01; 34	23,5	12	24	520
ROL005	◎ 05; 34	23,5	12	24	810
ROL005	● 17; 34	23,5	12	24	810



THE.SANIGLAZE

RODOLFO 120 | 120 x 45

lavabo sospeso/appoggio con
doppia vasca
2 fori (predisposto 6 fori)

wall-hung/countertop with
double-bowl washbasin 2 holes
with arrangements for 6 holes



schede tecniche
technical drawing

codice	colore	kg	pz. pallet Italia	pz. pallet Export	euro
CLASSIC COLORS					
ROL006	○ 01; 34	30	10	20	570
ROL006	◎ 05; 34	30	10	20	860
ROL006	● 17; 34	30	10	20	860

	codice	colore	kg	pz. pallet Italia	pz. pallet Export	euro
tasselli per fissaggio lavabi sospesi	ACA007		0,3	-	-	12
<i>fitting system kit for wall-hung washbasins</i>						
* fissaggi non inclusi nel prezzo <i>fitting system kit not included in the price</i>						

	CLASSIC COLORS					
piletta universale lavabo up & down tappo in ceramica	ACA036	○ 01; 34	0,3	-	-	75
<i>up & down universal drain with ceramic cover for washbasins</i>	ACA038	◎ 05; 34	0,3	-	-	81
	ACA038	● 17; 34	0,3	-	-	81

piletta universale lavabo up & down cromo	ACA032		0,3	-	-	69
<i>chrome up & down drain for washbasin</i>						

piletta universale Pop con troppopieno integrato	ACA061	71	0,5	-	-	173
<i>Pop universal drain with integral overflow</i>	ACA061	◎ 05; 34	0,5	-	-	196
	ACA061	● 17; 34	0,5	-	-	196

sifone cilindrico cromo <i>chrome siphon</i>	ACA022		1	-	-	109
---	---------------	--	---	---	---	------------

sifone cilindrico - <i>siphon</i>	ACA099	◎ 05	1	-	-	109
	ACA099	● 17	1	-	-	109

PASSEPARTOUT

Ceramic Shelf

Trasversalità e dinamismo definiscono la mensola per lavabi PASSEPARTOUT, che reinterpreta lo spazio con intelligenza e astuzia. Questa pratica mensola risponde a diverse esigenze facilitando una progettazione "libera" dell'ambiente bagno permettendo un facile inserimento e gestione idraulica dei lavabi centrostanza anche in quegli ambienti che sino ad oggi erano proibitivi da un punto di vista di gestione del carico, scarico e inserimento della rubinetteria dedicata. Come suggerisce il nome «pas partù» (propr. «passa dappertutto») è un'analogia: una chiave che serve ad aprire più serrature, un sistema per risolvere qualsiasi problema. PASSEPARTOUT è concepita per essere affiancata a un'infinita varietà di lavabi a colonna, simulando così l'effetto dei lavabi "centrostanza" tenuti leggermente scostati dal muro. Offre una soluzione elegante per nascondere gli scarichi standard, ottimizza gli spazi mantenendo l'ordine e la pulizia visiva del bagno.

Transversality and dynamism define the PASSEPARTOUT shelf for basins, which reinterprets space with intelligence and cunning. This practical shelf meets various needs, facilitating a "free" design of the bathroom environment, allowing easy insertion and hydraulic management of freestanding basins even in spaces previously prohibitive in terms of water inlet, outlet and dedicated fixture installation. As the name "PASSEPARTOUT" suggests (literally "goes everywhere"), it's an analogy: a key that opens multiple locks, a system for solving any problem. PASSEPARTOUT is designed to be paired with an infinite variety of pedestal basins, thus simulating the effect of freestanding basins kept slightly away from the wall. It offers an elegant solution to hide standard drains, it optimizes space, and maintains the order and visual cleanliness of the bathroom.



Collezione Passepartout
Collection Passepartout





PASSEPARTOUT SYSTEM

La mensola Passepartout offre una soluzione elegante per nascondere gli scarichi standard e, grazie al suo design intelligente, consente di posizionare la rubinetteria in modo pratico e senza necessità di interventi murari. Passepartout può essere accostata ai nostri lavabi a colonna Jolie e Brera; ma può anche essere abbinata a centrostanza di altri brand (consigliamo però di verificarne le caratteristiche tecniche).

The Passepartout shelf offers an elegant solution to conceal standard drains and, thanks to its smart design, allows for the practical placement of the faucets without the need for masonry work. Passepartout can be mounted with our Jolie and Brera column washbasins; but it can also be matched with freestanding washbasins from other brands (however, we recommend checking their technical specifications).



con rubinetto a 35°
(no foro scarico sulla ceramica)
con rubinetto a 35°
(no foro scarico sulla ceramica)

c/n rubinetto dietro centrale
(foro scarico sulla ceramica)
c/n rubinetto dietro centrale
(foro scarico sulla ceramica)

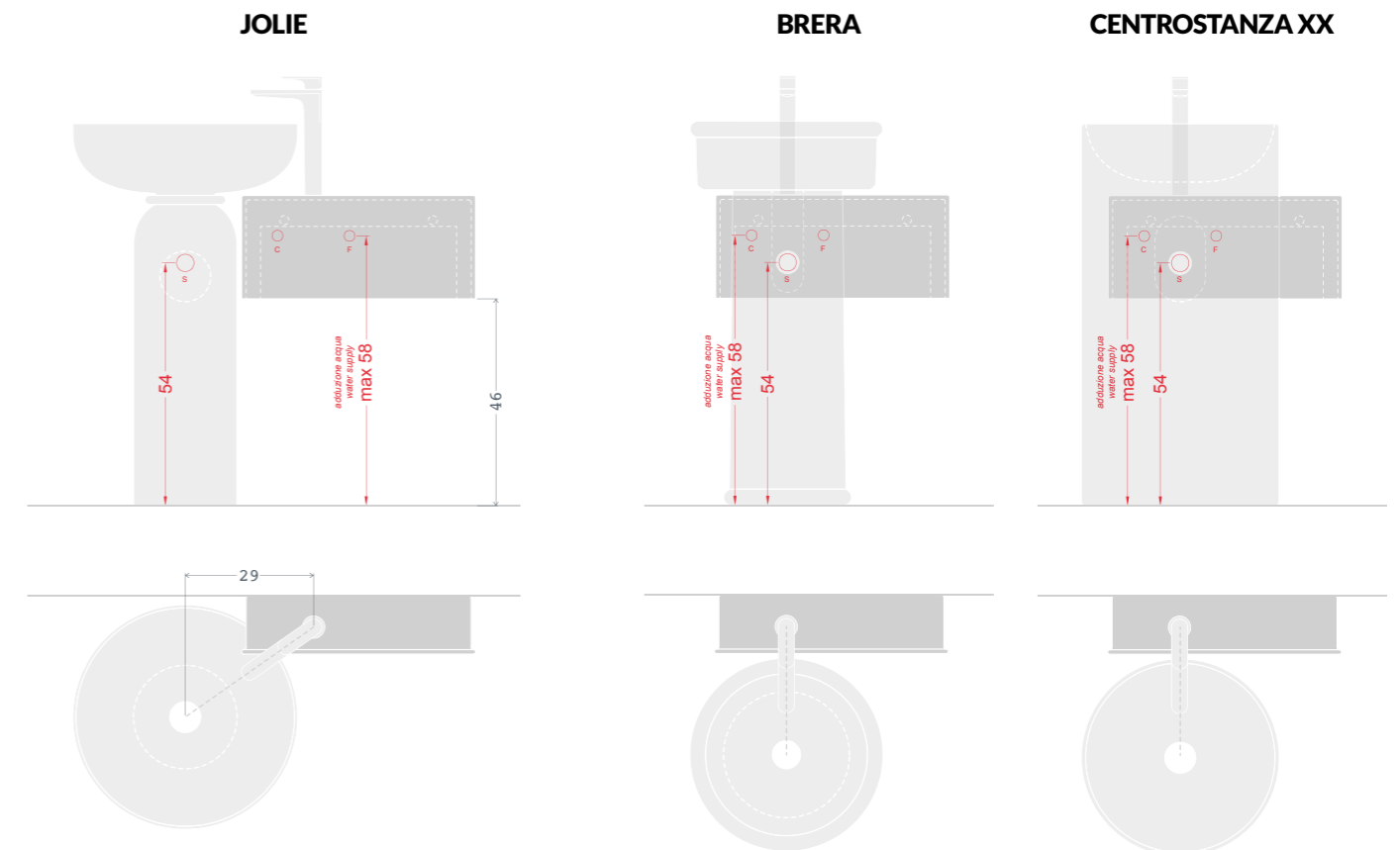

PASSEPARTOUT PLACEMENT

La versatilità di Passepartout le consente di adattarsi perfettamente ai lavabi Jolie e Brera, ed è installabile sia a destra che a sinistra. Al momento dell'ordine, verificare quale schema di fori sulla ceramica sia necessario per l'installazione dei pezzi!

The versatility of Passepartout allows it to perfectly fit the Jolie and Brera column washbasins, and it can be installed both on the right and left sides. At the time of ordering, please check which hole pattern on the ceramic is needed for the installation of the pieces!

SCHEMA 1 (OSL014)

Fori rubinetteria e scarico acqua per collegamento sifone a sinistra (installazione alla DX del lavabo)
Tap holes and water drain for siphon connection on the the left (installation to the right of the sink)

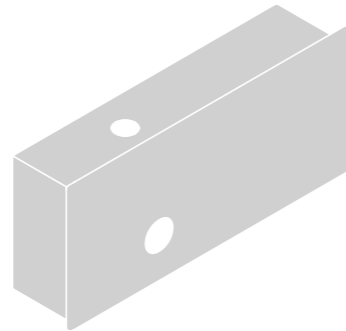

SCHEMA 2 (OSL015)

Fori rubinetteria e scarico acqua per collegamento sifone a destra (installazione alla SX del lavabo)
Tap holes and water drain for siphon connection on the the right (installation to the left of the sink)

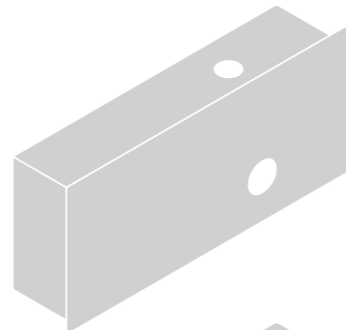

SCHEMA 3 (OSL016)

Foro rubinetteria a destra
Right faucet hole

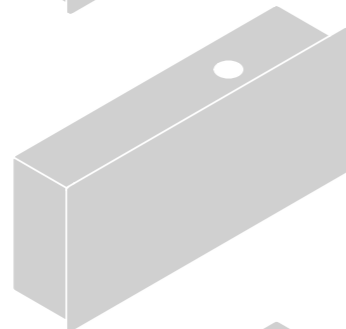

SCHEMA 4 (OSL017)

Foro rubinetteria a sinistra
Left faucet hole

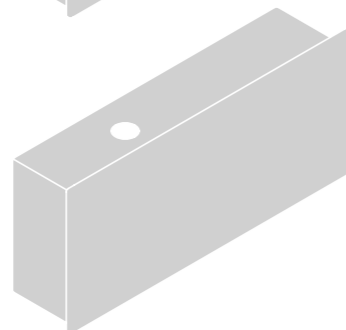

I fori verranno fatti dopo la fase di cottura del pezzo, quindi la ceramica potrebbe presentare delle leggere imperfezioni.

The holes will be made after the firing process of the piece, so the ceramic may have slight imperfections.

PASSEPARTOUT VARIATIONS

colori e finiture - colors and finishes...

CLASSIC COLORS



bianco lucido / glossy white



nero lucido / glossy black

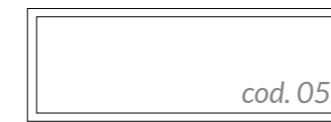

bianco matt / matt white



nero matt / matt black

MATT COLORS



grigio oliva / grey olive



blu avio / blue avio



verde foresta / green foresta



verde salvia / green salvia



marrone tortora / brown tortora



marrone matera / brown matera



ghiaia / gravel



sabbia / sand

GLOSSY COLORS



rosè / rosè



biscotto / biscuit



cotone / cotton



lichene / lichen

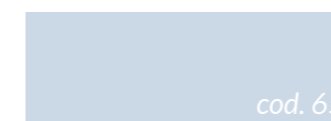

celeste / pale blue

PASSEPARTOUT OVERVIEW

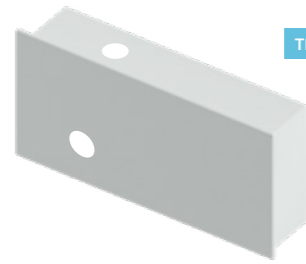

THE.SANIGLAZE

PASSEPARTOUT 52x23 p13

mensola di ceramica

Schema 1

Fori rubinetteria e scarico
acqua per collegamento
sifone a sinistra

*Tap holes and water drain
for siphon connection on the
the left*



schede tecniche
technical drawing

codice	colore	kg	pz. pallet Italia	pz. pallet Export	euro
CLASSIC COLORS					
OSL014	01; 34	7	-	-	285
OSL014	03; 34	7	-	-	530
OSL014	05; 34	7	-	-	530
OSL014	17; 34	7	-	-	530
MATT COLORS					
OSL014	34	7	-	-	530
GLOSSY COLORS					
OSL014	34	7	-	-	530

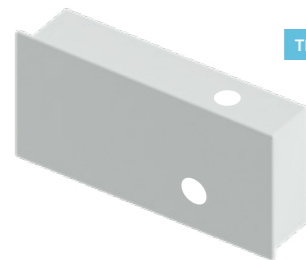

THE.SANIGLAZE

PASSEPARTOUT 52x23 p13

mensola di ceramica

Schema 2

Fori rubinetteria e scarico
acqua per collegamento
sifone a destra

*Tap holes and water drain
for siphon connection on the
the right*



schede tecniche
technical drawing

codice	colore	kg	pz. pallet Italia	pz. pallet Export	euro
CLASSIC COLORS					
OSL015	01; 34	7	-	-	285
OSL015	03; 34	7	-	-	530
OSL015	05; 34	7	-	-	530
OSL015	17; 34	7	-	-	530
MATT COLORS					
OSL015	34	7	-	-	530
GLOSSY COLORS					
OSL015	34	7	-	-	530

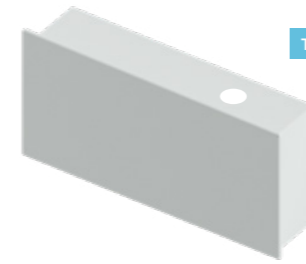

THE.SANIGLAZE

PASSEPARTOUT 52x23 p13

mensola di ceramica

Schema 3

Foro rubinetteria a destra

Right faucet hole



schede tecniche
technical drawing

codice	colore	kg	pz. pallet Italia	pz. pallet Export	euro
CLASSIC COLORS					
OSL016	01; 34	7	-	-	285
OSL016	03; 34	7	-	-	530
OSL016	05; 34	7	-	-	530
OSL016	17; 34	7	-	-	530
MATT COLORS					
OSL016	34	7	-	-	530
GLOSSY COLORS					
OSL016	34	7	-	-	530

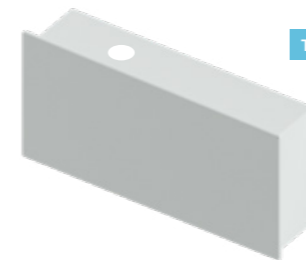

THE.SANIGLAZE

PASSEPARTOUT 52x23 p13

mensola di ceramica

Schema 4

Foro rubinetteria a sinistra

Left faucet hole



schede tecniche
technical drawing

codice	colore	kg	pz. pallet Italia	pz. pallet Export	euro
CLASSIC COLORS					
OSL017	01; 34	7	-	-	285
OSL017	03; 34	7	-	-	530
OSL017	05; 34	7	-	-	530
OSL017	17; 34	7	-	-	530
MATT COLORS					
OSL017	34	7	-	-	530
GLOSSY COLORS					
OSL017	34	7	-	-	530

MAGICLIGHT

Ultraviolet Germicidal Irradiation Device

Magilight è igiene totale a 360°. Un sistema innovativo di sanificazione a raggi ultravioletti che offre una protezione profonda, eliminando batteri e germi invisibili, e garantendo la massima pulizia all'interno della camera del WC. Un piccolo dispositivo che racchiude un mondo di funzionalità: il suo design intelligente si integra nel sedile del WC, e grazie a un sensore di movimento, il modulo superiore si illumina, creando anche una delicata luce ambientale. Con Magilight puoi trasformare ogni momento in un'opportunità di igiene impeccabile, proteggendo te stesso e la tua famiglia da batteri invisibili, in modo semplice, sicuro ed elegante.

Magilight offers total hygiene at 360°. An innovative ultraviolet sterilization system that provides deep protection, eliminating invisible bacteria and germs, ensuring maximum cleanliness inside the toilet bowl. A small device packed with functionality: its intelligent design integrates seamlessly into the toilet seat, and thanks to a motion sensor, the upper module lights up, also creating a soft ambient light. With Magilight, you can turn every moment into an opportunity for impeccable hygiene, protecting yourself and your family from invisible bacteria, in a simple, safe, and elegant way.



Magilight





STERILIZATION MODE-ON

Quando il sedile è chiuso, la modalità di sterilizzazione si attiva automaticamente dopo 10 secondi e passa in modalità sleep dopo 3 minuti di sterilizzazione. Durante il processo, viene emessa una luce blu insieme alle radiazioni UVC.

When the seat is closed, the sterilization mode activates automatically after 10 seconds and enters sleep mode after 3 minutes of sterilization.

During the process, a blue light is emitted along with the UVC radiation.



STERILIZATION NOT ACTIVE

In modalità sterilizzazione attiva, quando il coperchio viene aperto anche solo di 10°, la sterilizzazione si interrompe immediatamente. L'illuminazione rimane attiva per 10 secondi, per poi passare alla modalità sleep.

In active sterilization mode, when the seat is opened by even just 10°, the sterilization stops immediately. The lighting remains on for 10 seconds, then switches to sleep mode



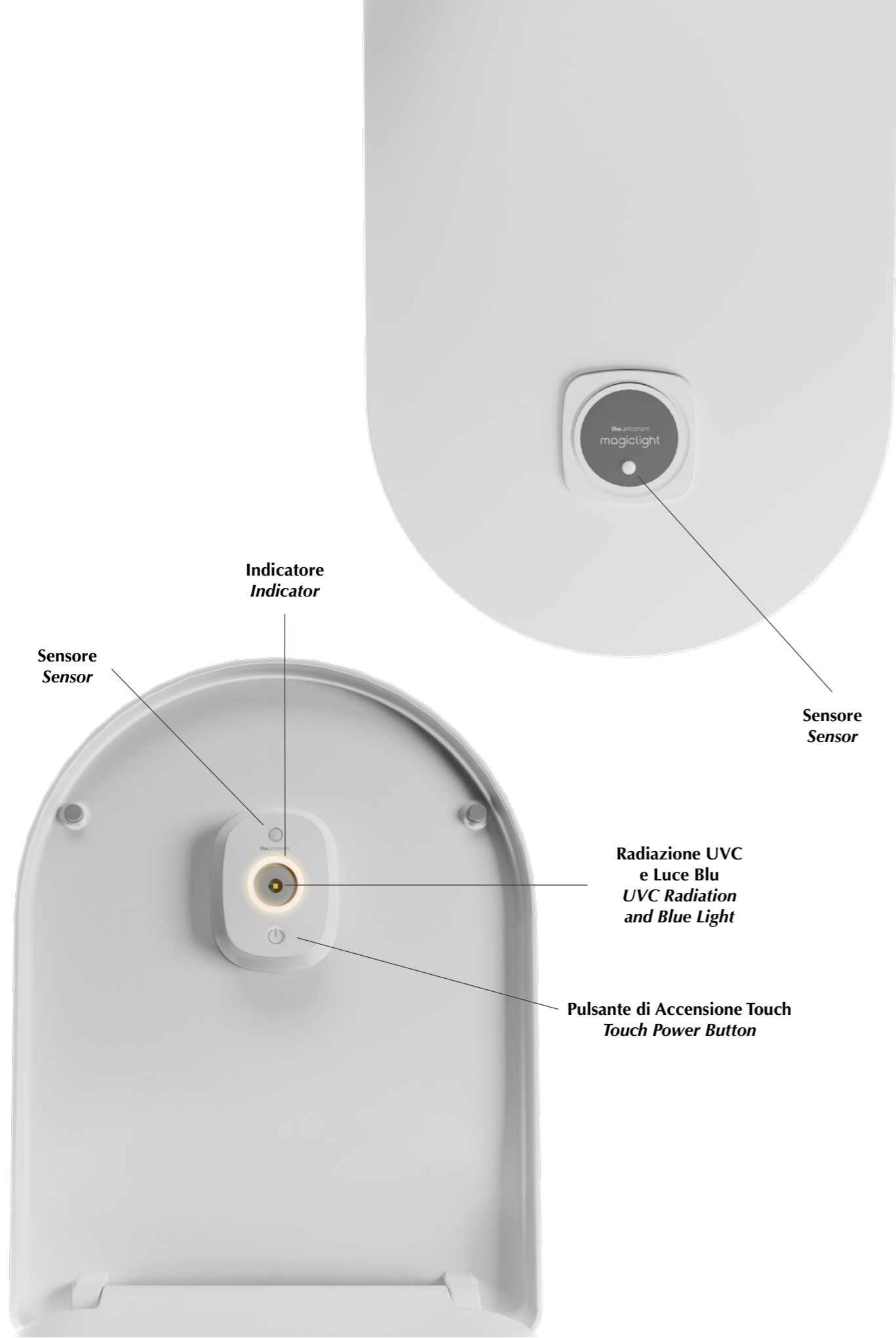

Sensore
Sensor

Indicatore
Indicator

Sensore
Sensor

Radiazione UVC
e Luce Blu
UVC Radiation
and Blue Light

Pulsante di Accensione Touch
Touch Power Button



Sterilizzazione a raggi
ultravioletti C (UVC)
Ultraviolet - C (UVC)
Sterilization



Sistema intelligente
contro l'uso improprio
Intelligent System
Against Incorrect Use



Sensore di movimento
e luce ambientale
Motion Sensor
and Ambient Light

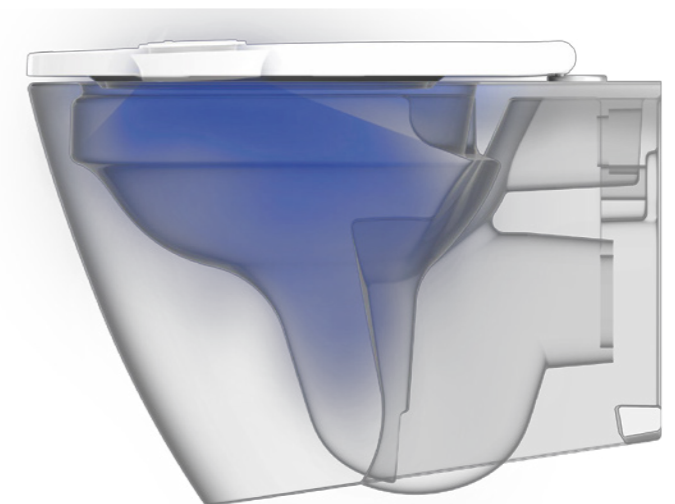
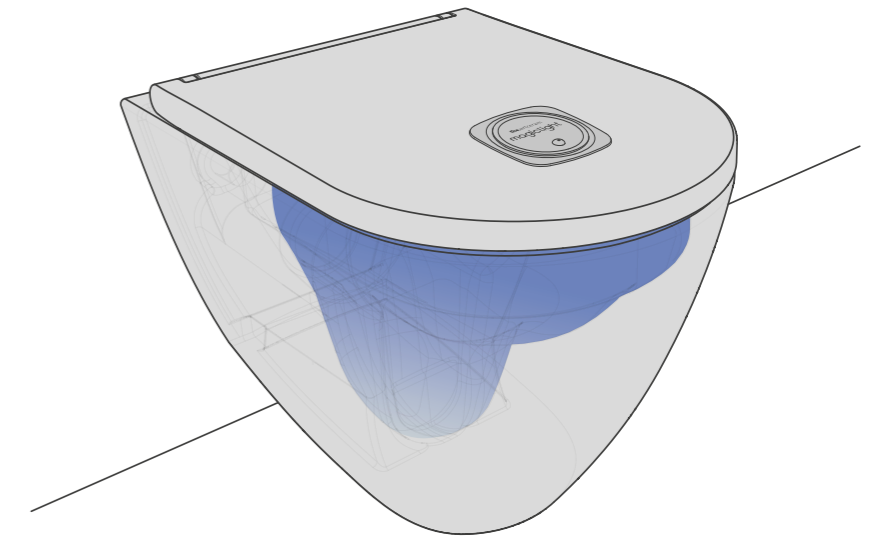

MAGICLIGHT SYSTEM

Igiene totale a 360°, sia per WC a terra che sospesi! Il nuovo sistema di igienizzazione è installabile su tutti i sedili delle seguenti collezioni, scopri qui di seguito:

Total hygiene at 360°, for both back to wall and wall-hung WC! The new sanitation system is installable on all the seat covers of the following collections, discover them below:

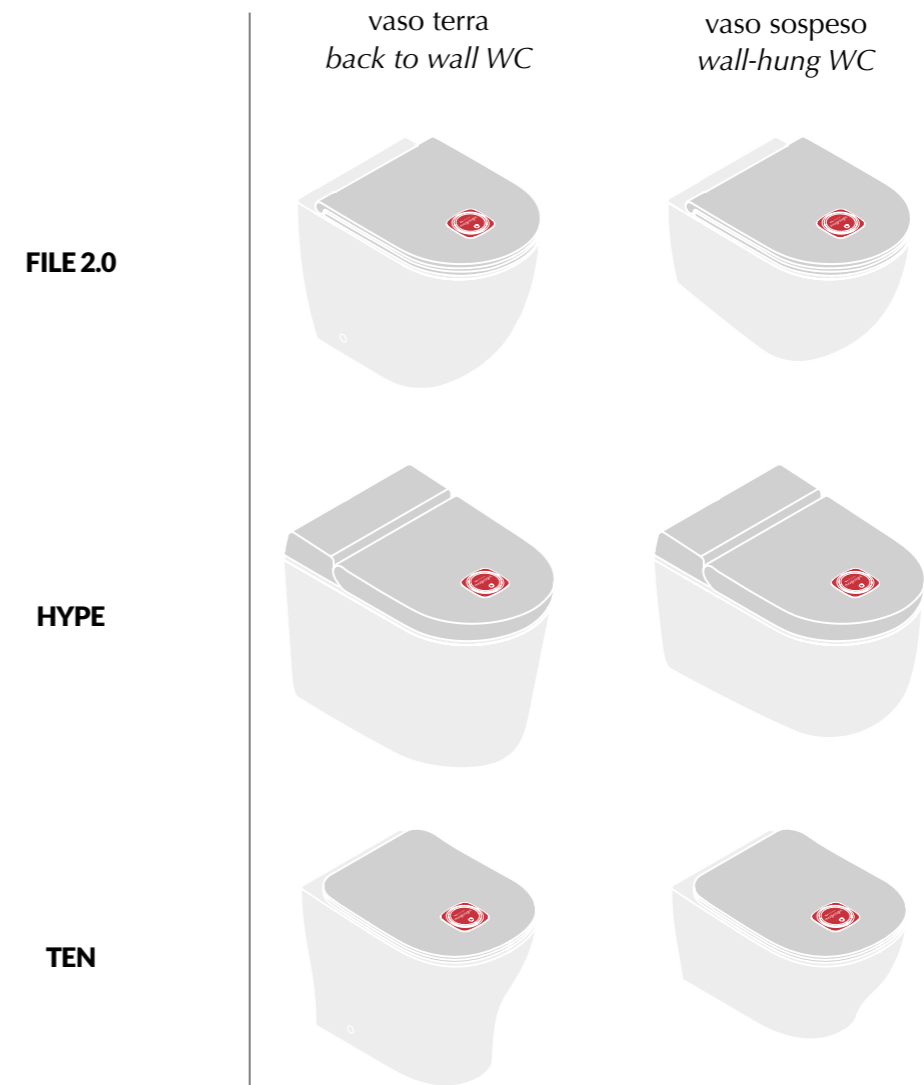
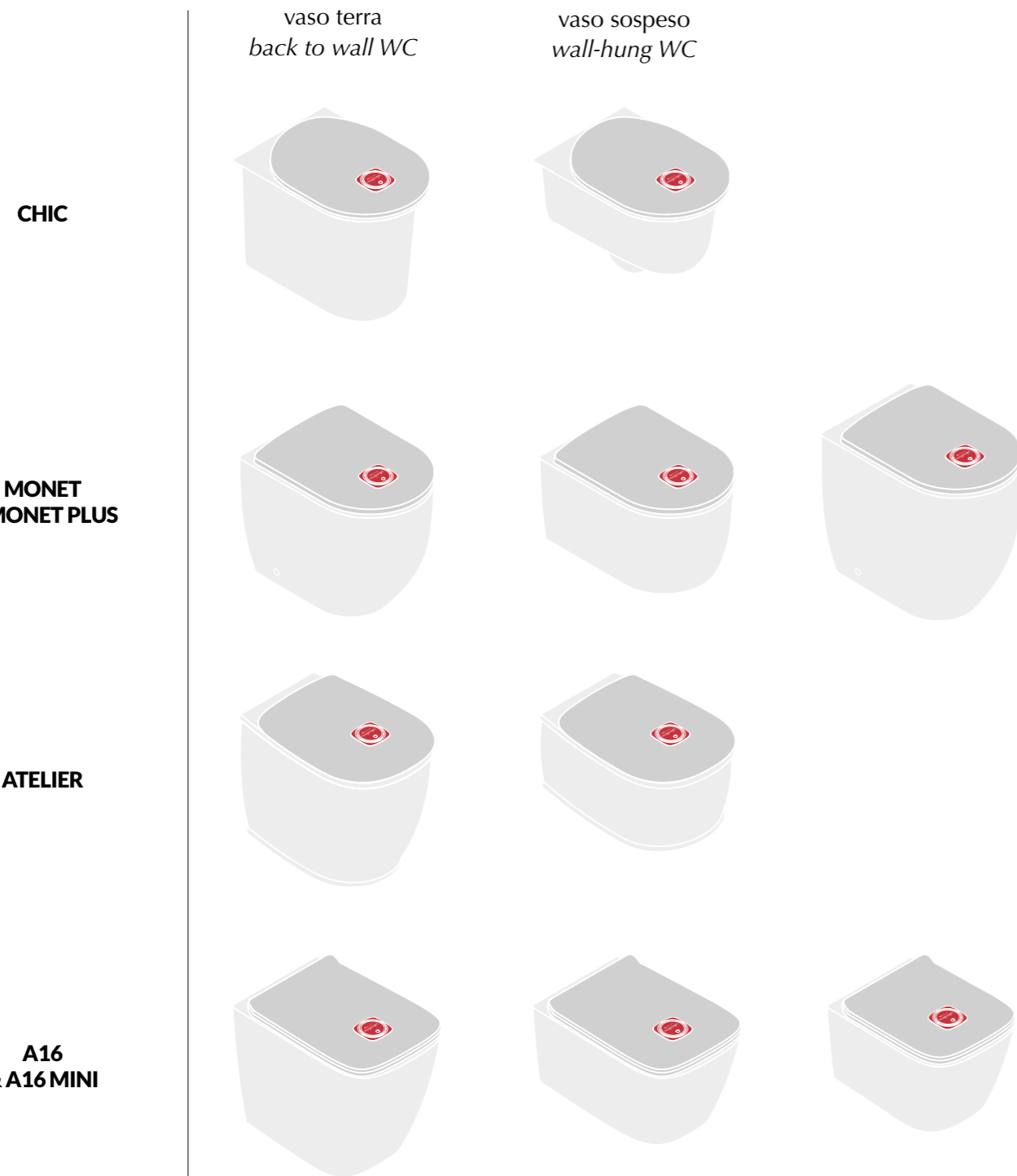

MAGICLIGHT OVERVIEW



	codice	colore	kg	pz. pallet Italia	pz. pallet Export	euro
ATELIER	AZA001	○ 01; 20	3,5	-	-	275

seduta per WC frizionata
a sgancio rapido Magiclight

easy take off soft-close
Magiclight WC seat



	codice	colore	kg	pz. pallet Italia	pz. pallet Export	euro
CHIC	CHA001	○ 01; 20	4	-	-	275

seduta per WC frizionata
a sgancio rapido Magiclight

easy take off soft-close
Magiclight WC seat



	codice	colore	kg	pz. pallet Italia	pz. pallet Export	euro
TEN	TEA012	○ 01; 20	3,5	-	-	275

seduta per WC frizionata
a sgancio rapido Magiclight

easy take off soft-close
Magiclight WC seat



	codice	colore	kg	pz. pallet Italia	pz. pallet Export	euro
MONET	MNA001	○ 01; 20	3,5	-	-	275

seduta per WC frizionata
a sgancio rapido Magiclight

easy take off soft-close
Magiclight WC seat



	codice	colore	kg	pz. pallet Italia	pz. pallet Export	euro
A16 MINI	ASA002	○ 01; 20	3,5	-	-	275

seduta per WC frizionata
a sgancio rapido Magiclight

easy take off soft-close
Magiclight WC seat



	codice	colore	kg	pz. pallet Italia	pz. pallet Export	euro
FILE 2.0 FLAT	FLA016	○ 01; 20	3,5	-	-	275

seduta per WC frizionata
a sgancio rapido Magiclight

easy take off soft-close
Magiclight WC seat



	codice	colore	kg	pz. pallet Italia	pz. pallet Export	euro
A16	ASA006	○ 01; 20	3,5	-	-	275

seduta per WC frizionata
a sgancio rapido Magiclight

easy take off soft-close
Magiclight WC seat



	codice	colore	kg	pz. pallet Italia	pz. pallet Export	euro
HYPE	HYA001	○ 01; 20	3,5	-	-	275

seduta per WC frizionata
a sgancio rapido Magiclight

easy take off soft-close
Magiclight WC seat

FILE 2.0

COLLECTION
UPDATE

New wc seat

Nel corso degli anni, la collezione File ha visto numerosi aggiornamenti, sempre guidati dal desiderio di innovare e perfezionare! Questa volta abbiamo deciso di dare nuovo slancio ad una delle nostre linee più iconiche, mantenendo le morbide curve che l'hanno resa celebre, ma introducendo dettagli e soluzioni che la proiettano verso un design ancora più moderno e funzionale. Il cuore del rinnovamento risiede nell'introduzione di una nuova tavoletta, pensata per soddisfare stili e contesti diversi. Il sedile FLAT, con il suo design sottile e raffinato, dona un tocco di leggerezza e modernità, perfetto per gli ambienti residenziali che ricercano pulizia formale e semplicità. Con File 2.0, The.Artceram conferma il suo impegno nel ridefinire l'arredo bagno, offrendo soluzioni che uniscono design, funzionalità e adattabilità, senza mai rinunciare a quel tocco di stile che rende ogni ambiente unico.

Over the years, the File collection has undergone numerous updates, always driven by the desire to innovate and improve! This time, we decided to breathe new life into one of our most iconic lines, preserving the soft curves that made it famous while introducing details and solutions that elevate its design to be even more modern and functional. At the heart of this renewal lies the introduction of a new WC seats, designed to meet diverse styles and contexts. The FLAT seat, with its sleek and refined design, adds a touch of lightness and modernity, perfect for residential spaces seeking formal simplicity and elegance. With File 2.0, The.Artceram reaffirms its commitment to redefining bathroom furnishings, offering solutions that blend design, functionality, and adaptability, all while maintaining that distinctive touch of style that makes every space unique.



FLV004 01
+ FLA016 01



FILE 2.0 VARIATIONS

colori e finiture - *colors and finishes...*

CLASSIC COLORS



bianco lucido / *glossy white*



nero lucido / *glossy black*

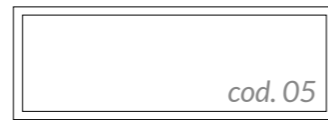

bianco matt / *matt white*



nero matt / *matt black*

MATT COLORS



grigio oliva / *grey olive*



blu avio / *blue avio*



verde foresta / *green foresta*



verde salvia / *green salvia*



marrone tortora / *brown tortora*



marrone matera / *brown matera*



ghiaia / *gravel*



sabbia / *sand*

GLOSSY COLORS



rosè / *rosè*



biscotto / *biscuit*

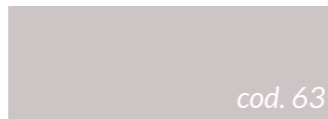

cotone / *cotton*

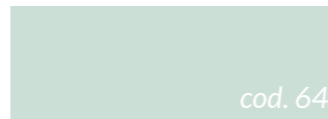

lichene / *lichen*

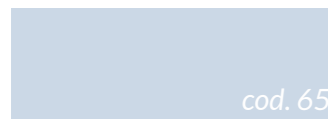

celeste / *pale blue*

FILE 2.0 OVERVIEW



FILE 2.0 FLAT

seduta Flat per WC frizionata
a sgancio rapido

easy take off soft-close
Flat WC seat

codice	colore	kg	pz. pallet Italia	pz. pallet Export	euro
CLASSIC COLORS					
FLA016	○ 01; 71	3	-	-	180
FLA016	● 03; 71	3	-	-	270
FLA016	◎ 05; 71	3	-	-	270
FLA016	⦿ 17; 71	3	-	-	270
MATT COLORS					
FLA016		3	-	-	270
GLOSSY COLORS					
FLA016		3	-	-	270

*solo per vasi File 2.0 con sistema di scarico Reel (FLV006/FLV007)
e vaso monoblocco (FLV003); NON è installabile sui vasi Rimless!

*only for File 2.0 WC with Reel flushing system (FLV006/FLV007)
and close-coupled WC (FLV003); NOT installable on Rimless sanitaryware!

AQUANIT

Shower Trays Collection

Con uno spessore ridotto di soli 15 mm, i piatti doccia Aquanit di The.Artceram ridefiniscono il concetto di minimalismo nel bagno, offrendo una soluzione straordinariamente sottile e moderna. Realizzati interamente in porcellana al 100%, combinano la bellezza della ceramica con caratteristiche tecniche di altissimo livello, per un'esperienza di comfort senza compromessi. Grazie al loro design minimalista e alla lastra unica stampata con la corretta inclinazione per garantire il deflusso ottimale dell'acqua, i piatti doccia Aquanit coniugano estetica e funzionalità; sono disponibili in sei dimensioni e con lati rettificati in tinta. Lo spessore ridotto li rende perfetti per l'installazione a filo pavimento, un dettaglio che non solo elimina ogni barriera architettonica, ma esalta lo stile delle docce walk-in, trasformando lo spazio bagno in un ambiente continuo, elegante e funzionale.

With a reduced thickness of just 15 mm, The.Artceram's Aquanit shower trays redefine the concept of minimalism in the bathroom, offering an exceptionally sleek and modern solution. Crafted entirely from 100% porcelain, they combine the beauty of ceramics with top-tier technical features, ensuring a comfort experience without compromise. Thanks to their minimalist design and a single slab molded with the perfect slope for optimal water drainage, Aquanit shower trays seamlessly blend aesthetics and functionality. They are available in six sizes and feature rectified, color-matched edges for a refined finish. The reduced thickness makes them ideal for flush-to-floor installation—a detail that not only removes architectural barriers but enhances the style of walk-in showers, transforming the bathroom into a continuous, elegant, and functional space.



Collezione Aquanit
Collection Aquanit



PDR038 05



PDR038 05



PDR035 05

AQUANIT VARIATIONS

colori e finiture - colors and finishes...

CLASSIC COLORS



cod. 05

bianco matt / matt white

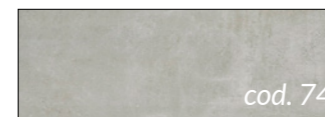

cod. 74

cemento matt / matt concrete

AQUANIT SYSTEM

I piatti doccia Aquanit combinano innovazione, design e funzionalità.

Sono realizzati in porcellana al 100%, una scelta che garantisce durabilità e una superficie igienica perfetta. Con uno spessore ridotto di soli 15 mm, offrono un accesso facile e senza barriere all'area doccia, ideale per soluzioni walk-in. La finitura antiscivolo e antimacchia assicura sicurezza e praticità, mentre la lastra unica con inclinazione integrata garantisce un drenaggio facile ed efficiente.

Un prodotto che unisce funzionalità, estetica e innovazione, per un'esperienza di comfort senza compromessi. I piatti doccia Aquanit sono progettati per l'installazione a filo pavimento, lo spessore dei bordi non è dello stesso colore della superficie superiore, ed inoltre non sono tagliabili su misura.

Aquanit shower trays combine innovation, design, and functionality. Made of 100% porcelain, this choice ensures durability and a perfectly hygienic surface. With a slim thickness of just 15 mm, they provide easy, barrier-free access to the shower area, making them ideal for walk-in solutions.

The anti-slip and stain-resistant finish ensures safety and practicality, while the single slab with integrated slope guarantees easy and efficient drainage. A product that combines functionality, aesthetics, and innovation for a comfort experience without compromise. Aquanit shower trays are designed for flush-to-floor installation, the edge thickness is not the same color as the top surface, and moreover they cannot be custom-cut.



superficie igienica
hygienic



facile accesso all'area doccia
easy access to the shower area



antimacchia
stain resistant



drenaggio facile
easy drainage



antiscivolo
non-slip



100% ceramica
100% porcelain tile

AQUANIT OVERVIEW



AQUANIT | 80 x 80

piatto doccia filo pavimento
con griglia inox inclusa

*flush-to-floor shower tray
with stainless grid included*



schede tecniche
technical drawing

codice	colore	kg	pz. pallet Italia	pz. pallet Export	euro
PDR033	☉ 05; 00	21	9	9	290
PDR033	● 74; 00	21	9	9	290



AQUANIT | 90 x 90

piatto doccia filo pavimento
con griglia inox inclusa

*flush-to-floor shower tray
with stainless grid included*



schede tecniche
technical drawing

codice	colore	kg	pz. pallet Italia	pz. pallet Export	euro
PDR034	☉ 05; 00	26	9	9	300
PDR034	● 74; 00	26	9	9	300



AQUANIT | 80 x 120

piatto doccia filo pavimento
con griglia inox inclusa

*flush-to-floor shower tray
with stainless grid included*



schede tecniche
technical drawing

codice	colore	kg	pz. pallet Italia	pz. pallet Export	euro
PDR035	05; 00	31	9	9	325
PDR035	74; 00	31	9	9	325



AQUANIT | 120 x 80

piatto doccia filo pavimento
con griglia inox inclusa

*flush-to-floor shower tray
with stainless grid included*



schede tecniche
technical drawing

codice	colore	kg	pz. pallet Italia	pz. pallet Export	euro
PDR037	05; 00	31	9	9	325
PDR037	74; 00	31	9	9	325

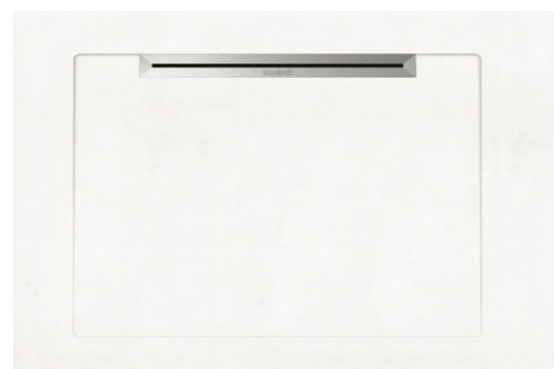

AQUANIT | 90 x 135

piatto doccia filo pavimento
con griglia inox inclusa

*flush-to-floor shower tray
with stainless grid included*



schede tecniche
technical drawing

codice	colore	kg	pz. pallet Italia	pz. pallet Export	euro
PDR036	05; 00	39	9	9	345
PDR036	74; 00	39	9	9	345



AQUANIT | 135 x 90





piatto doccia filo pavimento
con griglia inox inclusa

*flush-to-floor shower tray
with stainless grid included*



schede tecniche
technical drawing

codice	colore	kg	pz. pallet Italia	pz. pallet Export	euro
PDR038	05; 00	39	9	9	345
PDR038	74; 00	39	9	9	345

	codice	colore	kg	pz. pallet Italia	pz. pallet Export	euro
griglia inox 50cm per piatti doccia Aquanit PDR033, PDR034, PDR037, PDR038	ACA095	55	-	-	-	60
<i>50cm stainless steel grid for Aquanit shower trays PDR033, PDR034, PDR037, PDR038</i>						
supplemento griglia in tinta 50cm per piatti doccia Aquanit PDR033, PDR034, PDR037, PDR038	ACA095 	05	-	-	-	40
	ACA095 	74	-	-	-	40
<i>supplement for matching color grid for Aquanit shower trays PDR033, PDR034, PDR037, PDR038</i>						
griglia inox 70cm per piatti doccia Aquanit PDR035, PDR036	ACA098	55	-	-	-	60
<i>70cm stainless steel grid for Aquanit shower trays PDR035, PDR036</i>						
supplemento griglia in tinta 70cm per piatti doccia Aquanit PDR035, PDR036	ACA098 	05	-	-	-	40
	ACA098 	74	-	-	-	40
<i>supplement for matching color grid for Aquanit shower trays PDR035, PDR036</i>						
sifone ribassato obbligatorio	ACA094	55	-	-	-	45
<i>compulsory lowered siphon</i>						

