



HIDRA

Catalogo listino prezzi Texture 2020
Catalogue pricelist Texture 2020

Stone & Marble
Texture 2020



HIDRA
CERAMICA

 
MADE IN ITALY

Made in Italy è produzione originale, creativa e di qualità
Made in Italy is, original, creative and quality production

La nostra storia e i nostri valori

Our history and our values

Hidra inizia la propria attività produttiva nel 1989 ed è oggi, una delle aziende italiane leader nella produzione di articoli sanitari e per l'arredo bagno.

Con impianti tecnologicamente all'avanguardia, con l'impegno costante nella ricerca e i continui investimenti in risorse umane, Hidra ha conseguito eccellenti standard qualitativi realizzando prodotti sempre in linea con le ultime tendenze del mercato. Le collezioni Hidra caratterizzate da qualità e attenzione al design vengono progettate e realizzate attraverso la collaborazione con noti designers. Con l'obiettivo di raggiungere una sempre maggiore soddisfazione del cliente, la filosofia di qualità e design si amplia con il nuovo servizio che Hidra offre ai propri clienti: la possibilità di allestire i corner espositivi all'interno dei punti vendita con una comunicazione coordinata per i propri prodotti. I prodotti Hidra sono distribuiti uniformemente sul territorio nazionale e internazionale in ben 60 paesi.

EN

Hidra began manufacturing its own products from 1989 and nowadays is one of the Italian leading producers of sanitary wares and bathroom furnishing.

Through a combination of state of the art technological systems, constant commitments to resources and continues investments in human resources, the company has delivered solutions of consistently exceptional standards, manufacturing products that always suit the most innovative trends of the demanding markets. Hidra collections are characterized by quality and attention to the design, they are designed and manufactured through the constant collaboration with famous designers. With the commitment of achieving an always more efficient service of customer care Hidra has extended its philosophy of quality and design providing with a new service which includes the design of special corners dedicated to Hidra products in sales points. Hidra is distributed throughout Italy and abroad in over than 60 countries.



know how

Il saper fare artigianale è alla base della nostra attività
Artisanal know how at the base of our activity.

ricerca

Soluzioni altamente tecnologiche per consentire il risparmio idrico
Top technological solution for water saving.

design

prodotti portatori di qualità, capaci di dettare mode e tendenze.
High quality and trend-setting products.

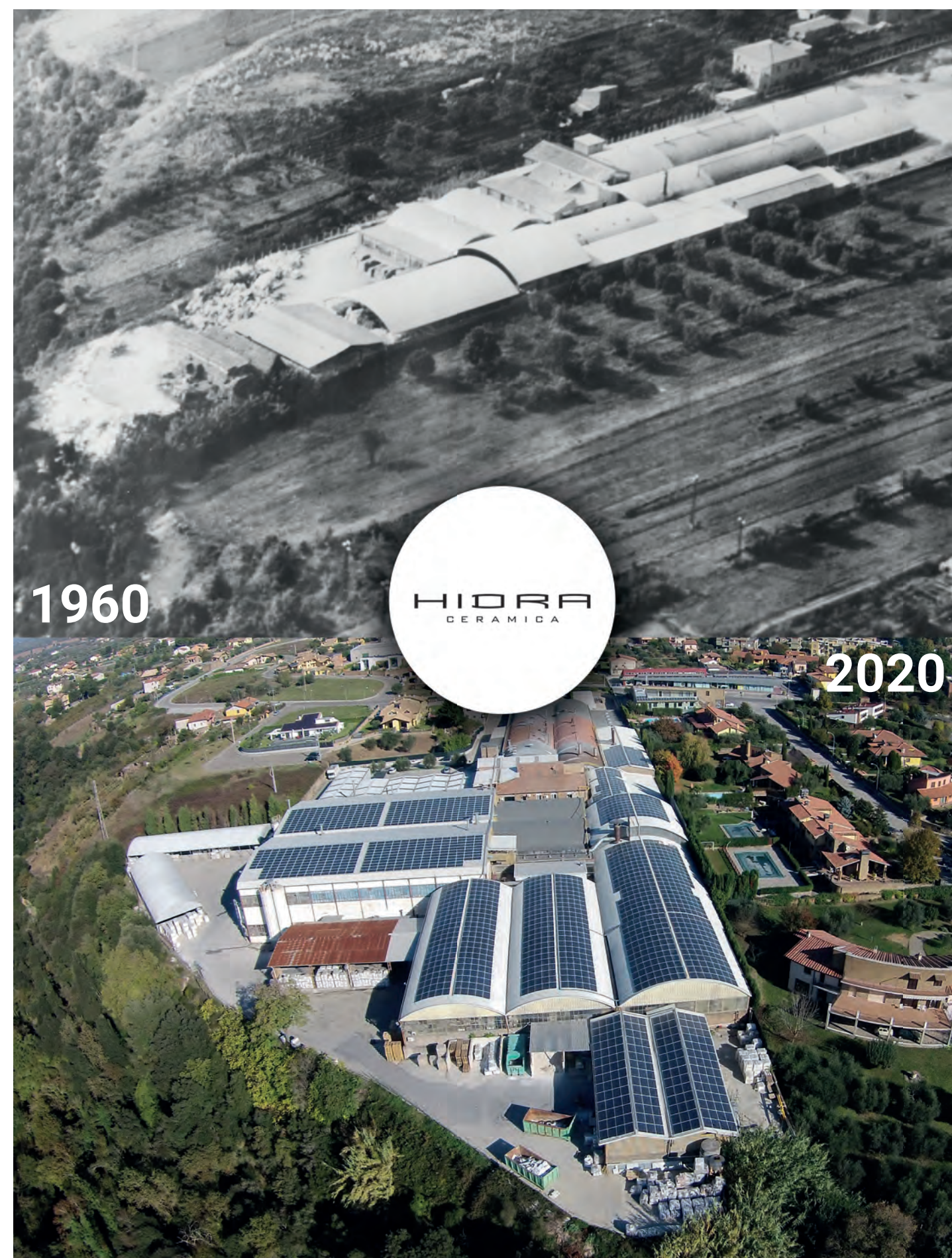



CERTIFICATO

Kiwa Cermet Italia S.p.A.
Società con socio unico,
soggetta all'attività di
direzione e coordinamento di
Kiwa Italia Holding Srl
Via Cadriano, 23
40057 Granarolo dell'Emilia
(BO)
Tel +39.051.459.3.111
Fax +39.051.763.382
E-mail: info@kivacermet.it
www.kiwa.it

CERMET



Reg. Numero	766- A	Valido da	2018-12-19
Primo rilascio	1999-03-25	Ultima modifica	2018-12-19
Scadenza	2021-12-11	Settore IAF	15

Certificato del Sistema di Gestione per la Qualità
ISO 9001:2015

Si dichiara che il sistema di gestione per la Qualità dell'Organizzazione:

HIDRA CERAMICA S.r.l.

è conforme alla norma UNI EN ISO 9001:2015 per i seguenti prodotti/servizi:

Progettazione e fabbricazione di articoli sanitari in Vitreous China e Fire Clay

Chief Operating Officer
Giampiero Belcredi

Il mantenimento della certificazione è soggetto a sorveglianza annuale e subordinato al rispetto dei requisiti contrattuali di Kiwa Cermet Italia.

Il presente certificato è costituito da 1 pagina.

HIDRA CERAMICA S.r.l.

Sede Legale

- Via Falerina 31/e 01033 Civita Castellana (VT) Italia

Sedi Oggetto di Certificazione

- Via Falerina 31/e 01033 Civita Castellana (VT) Italia



SGQ N° 007A
SGA N° 010D
PRD N° 069B
FSM N° 004I
PRS N° 089C



INDICE

INDEX

WIRE

LAVABI KIUB
Kiub wash basins

LAVABI GIÒ EVOLution
Gio' EVO countertop wash basins

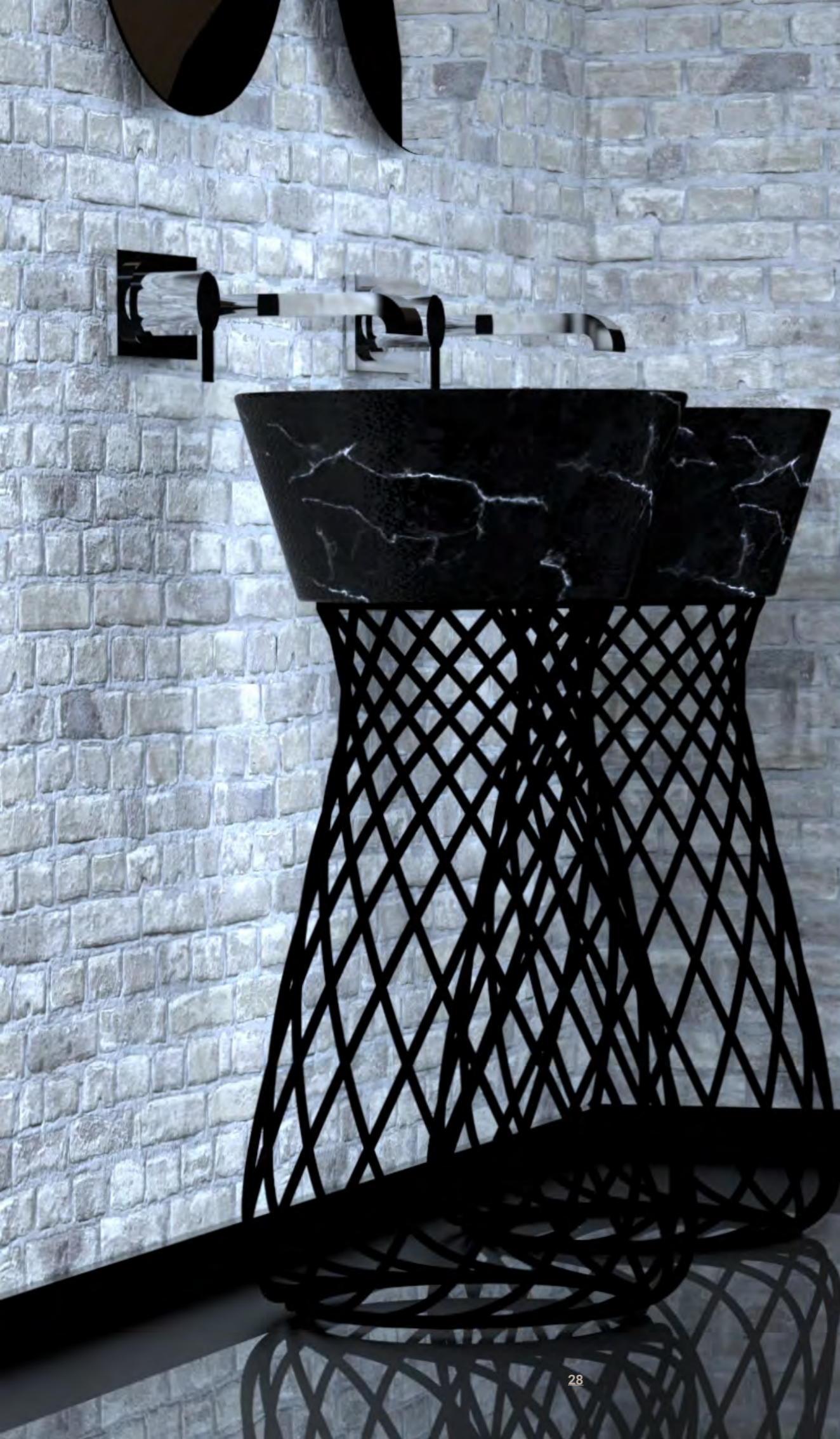

WIRE

Wire non è un classico lavabo mono-materico in ceramica, ma una composizione di due elementi distinti: la vasca, utilizzabile anche separatamente come lavabo d'appoggio, e la colonna portante, alleggerita dalla sua massa grazie ad una struttura di tondini metallici. La base è realizzata tramite la rivoluzione di 18 tondini che vengono percepiti come elementi sovrapposti, si ha così l'illusione ottica di una maglia.

Wire is not a one-piece freestanding washbasin, but a combination of two elements: the basin, that can be used as a countertop basin aswell, and the column, made up from a circular array of 18 steel rods that gives the optical illusion of a meshwork.



WIRE Ø43

lavabo appoggio
countertop washbasin

Accessori disponibili non inclusi/
Available accessories not included
art.P85 - P90 - P125



WIRE 43X43 H65

struttura metallica per Wire
Wire metal structure

Accessori disponibili non inclusi/
Available accessories not included
art.P82 - P50



ARTICOLO W1 — 9,3 kg 20 pz pallet Italia 34 pz pallet Export		euro
BIANCO LUCIDO	001 bianco lucido white	230
TEXTURE DISPONIBILI	100 ceppo di gré grey 99 ceppo di gré dark 101 white matt marble 102 black matt marble	490
DECORI DISPONIBILI	013 bianco/oro white/gold 014 bianco/platino white/platinum 063 bianco/oro rosa white/rose gold	600
DECORO NERO/ORO	020 nero/oro black/gold	715

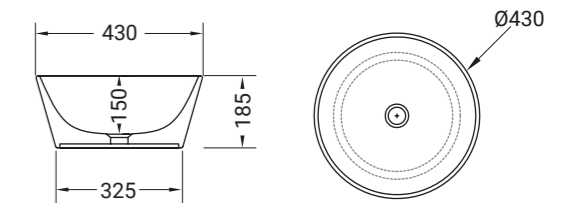

ARTICOLO W3 — 8 kg 8 pz pallet Italia 14 pz pallet Export		euro
BIANCO LUCIDO	001 bianco lucido white	980
COLORI DISPONIBILI	006 bianco matt white matt 026 nero matt black matt 009 nero lucido black shine	980

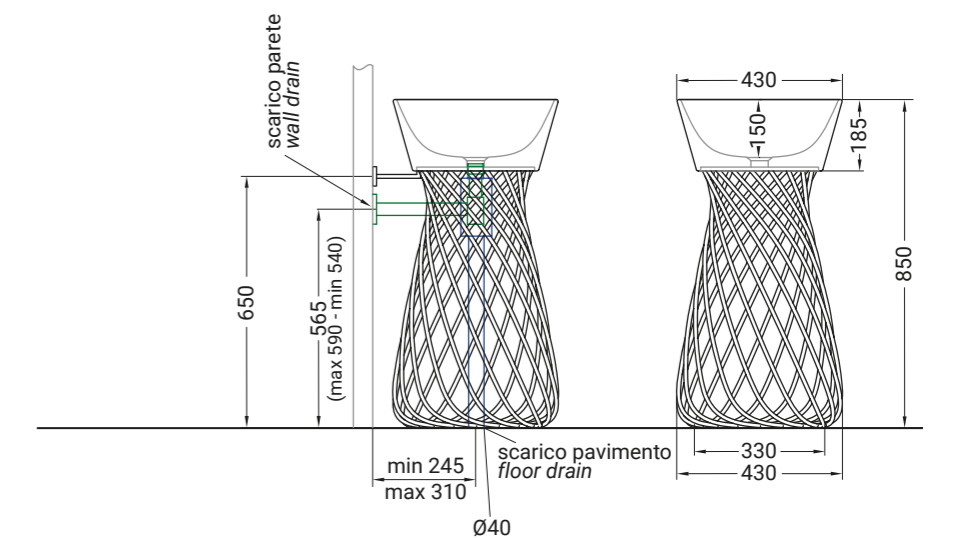

FASTER KIUB

LAVABI

KI50

51x46 cm



KI60

61x46 cm



KI80

81x46 cm



KI100

101x46 cm



KI100DX

101x46 cm



KI100SX

101x46 cm



KI120

122x46 cm



KI120DV

122x46 cm





FASTER KIUB

Una collezione rigorosa che si inserisce in un bagno contemporaneo orientato al design. Linee solide, di straordinaria leggerezza si avvicendano attraverso undici lavabi, dando vita ad ambienti diversi contraddistinti dal rigore, dallo spazio e linee armoniose. L'elemento caratterizzante di Kiub è l'ampia gamma di misure offerte, che possono essere usate singolarmente o in composizioni multiple. Undici soluzioni sapientemente differenziate, pensate per ambienti sempre nuovi, ora giocati sull'importanza di un lavabo ad una o due vasche di grandi dimensioni, ora sulla modularità e la ripetizione dei lavabi quadrati in sequenze geometriche.

A rigorous collection of basins that perfectly blend in a contemporary design-oriented bathroom. Solid and extremely soft lines presented in eleven basins for various bathroom areas characterized by formal rigour, space and balanced lines. The core element of Kiub is the large range of measures that can be used in unique or multiple solutions. Eleven basins wisely differentiated, conceived for various areas, singularly or with one or two big basins playing with modularity or repetition of square basins in geometrical sequences.







100
CEPPO DI GRE' - GREY



099
CEPPO DI GRE' - DARK



101
WHITE MATT MARBLE



102
BLACK MATT MARBLE

Le finitura e i colori presenti sono indicativi, soggetti a processi di stampa.
The finishings and colours here indicative because subject to printing processes.

FASTER KIUB

lavabo appoggio/sospeso
countertop/wall-hung washbasin

Accessori disponibili non inclusi/
Available accessories not included
art.P22 - P82 - P85 - P125

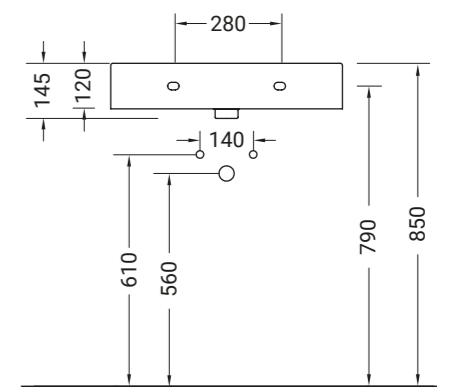
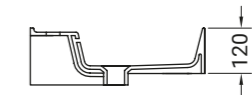
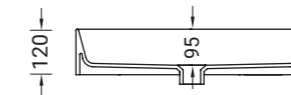
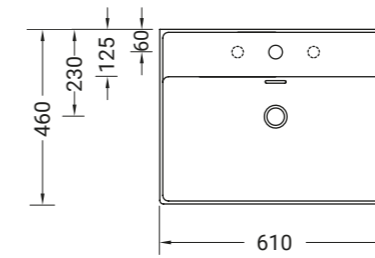

ARTICOLO KI60		15 kg 20 pz pallet Italia 34 pz pallet Export	euro
BIANCO LUCIDO	001	bianco lucido white	320
	TEXTURE DISPONIBILI		550
	100	ceppo di gré grey	
	99	ceppo di gré dark	
	101	white matt marble	
	102	black matt marble	

FASTER KIUB

lavabo sospeso/appoggio
wash basin wall hung/countertop

Accessori disponibili non inclusi/
Available accessories not included
art.P22 - P82 - P85 - P125



ARTICOLO KI50		14 kg 20 pz pallet Italia 34 pz pallet Export	euro
BIANCO LUCIDO	001	bianco lucido white	270
	TEXTURE DISPONIBILI		500
	100	ceppo di gré grey	
	99	ceppo di gré dark	
	101	white matt marble	
	102	black matt marble	

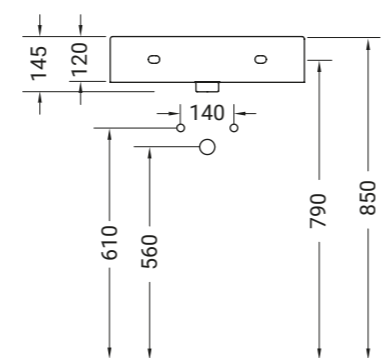
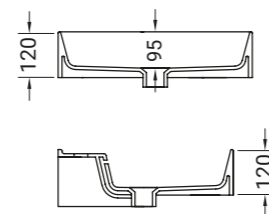
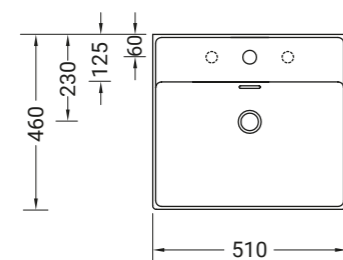

FASTER KIUB

lavabo appoggio/sospeso
countertop/wall-hung washbasin

Accessori disponibili non inclusi/
Available accessories not included
art.P22 - P82 - P85 - P125

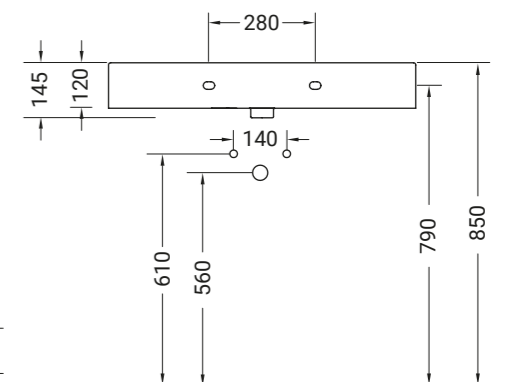
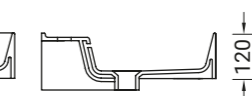
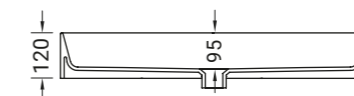
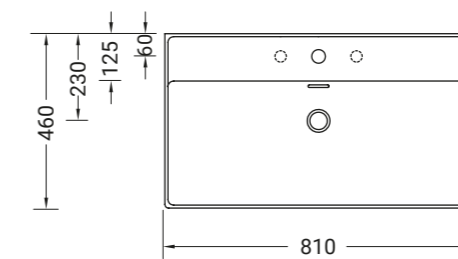

ARTICOLO KI80		21 kg 14 pz pallet Italia 25 pz pallet Export	euro
BIANCO LUCIDO	001	bianco lucido white	360
	TEXTURE DISPONIBILI		600
	100	ceppo di gré grey	
	99	ceppo di gré dark	
	101	white matt marble	
	102	black matt marble	

FASTER KIUB

lavabo appoggio/sospeso
countertop/wall-hung washbasin

Accessori disponibili non inclusi/
Available accessories not included
art.P22 - P82 - P85 - P125



ARTICOLO KI100 - 27,5 kg 12 pz pallet Italia 22 pz pallet Export	euro
BIANCO LUCIDO 001 bianco lucido white	400
TEXTURE DISPONIBILI 100 ceppo di gré grey 99 ceppo di gré dark 101 white matt marble 102 black matt marble	650

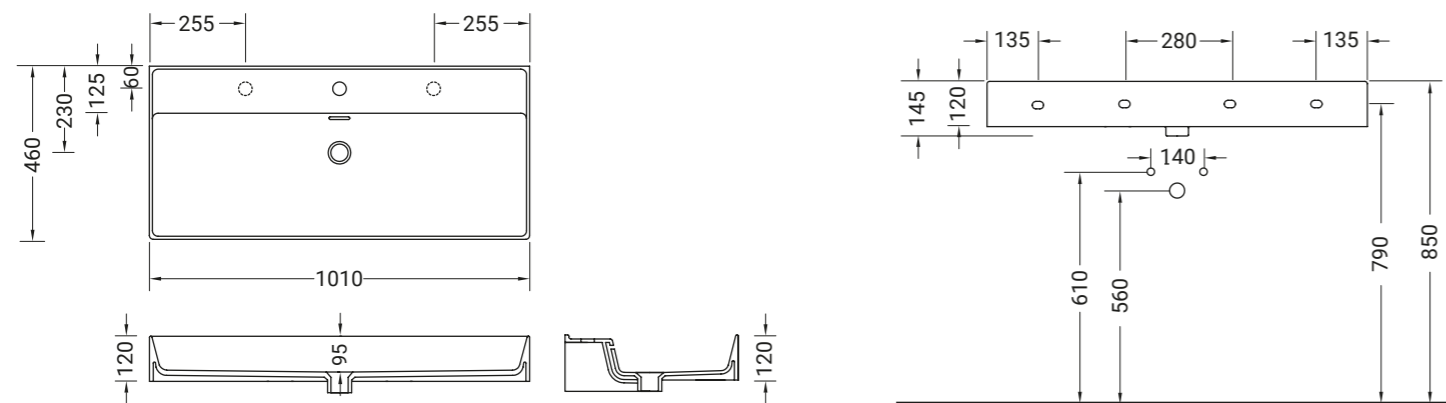

FASTER KIUB

lavabo appoggio/sospeso con piano dx
countertop/wall-hung washbasin with plane dx

Accessori disponibili non inclusi/
Available accessories not included
art.P22 - P82 - P85 - P125



ARTICOLO KI100DX - 26,0 kg 12 pz pallet Italia 22 pz pallet Export	euro
BIANCO LUCIDO 001 bianco lucido white	400
TEXTURE DISPONIBILI 100 ceppo di gré grey 99 ceppo di gré dark 101 white matt marble 102 black matt marble	650

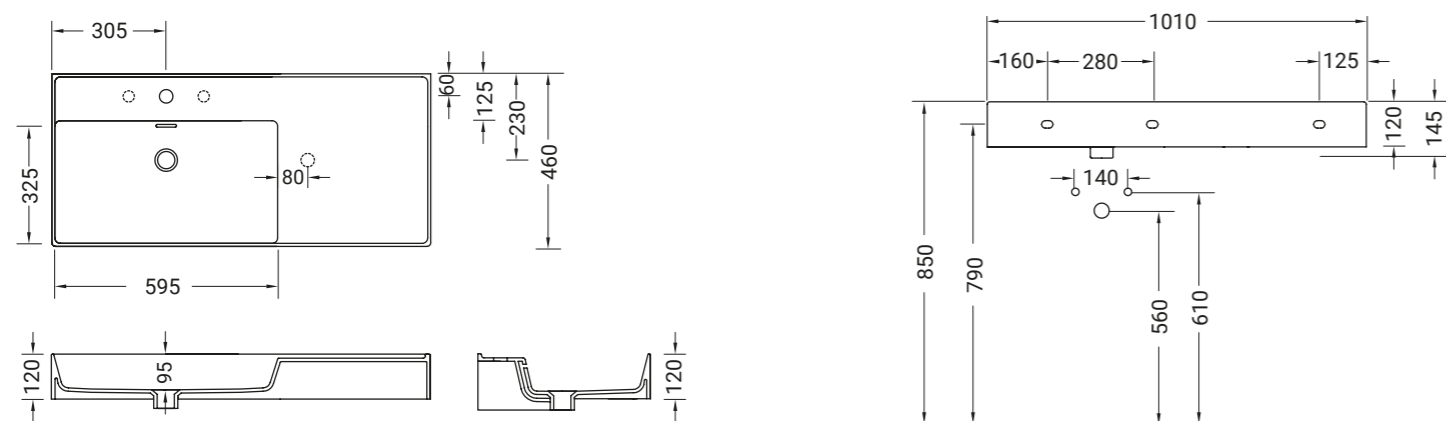

FASTER KIUB

lavabo appoggio/sospeso con piano sx
countertop/wall-hung washbasin with plane sx

Accessori disponibili non inclusi/
Available accessories not included
art.P22 - P82 - P85 - P125



ARTICOLO KI100SX - 26,0 kg 12 pz pallet Italia 22 pz pallet Export	euro
BIANCO LUCIDO 001 bianco lucido white	400
TEXTURE DISPONIBILI 100 ceppo di gré grey 99 ceppo di gré dark 101 white matt marble 102 black matt marble	650

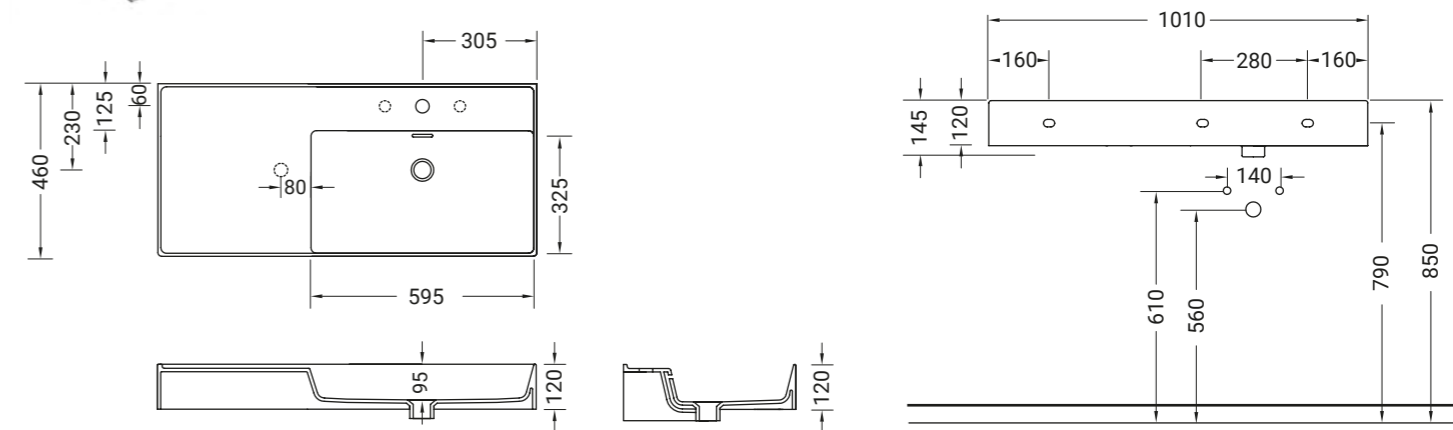

FASTER KIUB

lavabo appoggio/sospeso
countertop/wall-hung washbasin

Accessori disponibili non inclusi/
Available accessories not included
art.P22 - P82 - P85 - P125



ARTICOLO KI120 - 30,5 kg 10 pz pallet Italia 15 pz pallet Export	euro
BIANCO LUCIDO 001 bianco lucido white	460
TEXTURE DISPONIBILI 100 ceppo di gré grey 99 ceppo di gré dark 101 white matt marble 102 black matt marble	750

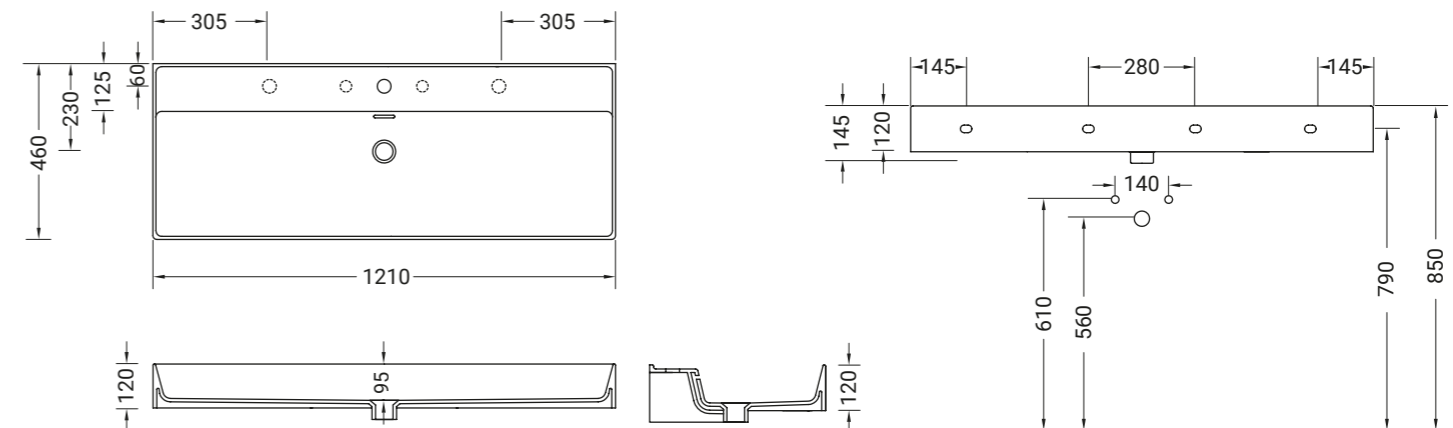

FASTER KIUB

lavabo appoggio/sospeso con doppia vasca
countertop/wall-hung washbasin with double bowl

Accessori disponibili non inclusi/
Available accessories not included
art.P22 - P82 - P85 - P125



ARTICOLO KI120DV - 29,5 kg 10 pz pallet Italia 15 pz pallet Export	euro
BIANCO LUCIDO	480
001 bianco lucido white	
TEXTURE DISPONIBILI	750
100 ceppo di gré grey	
99 ceppo di gré dark	
101 white matt marble	
102 black matt marble	

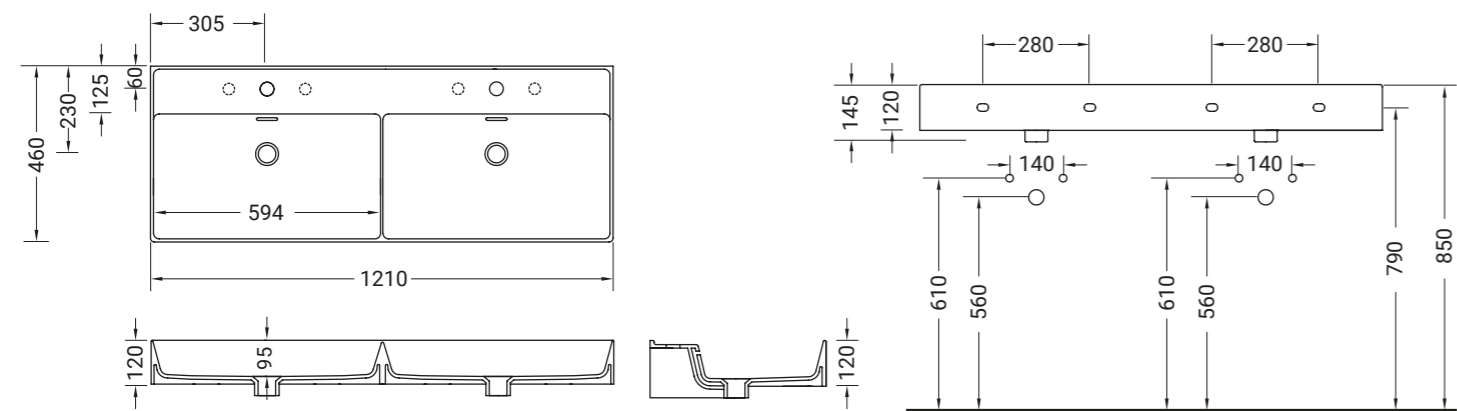

FASTER KIUB

struttura 60 - composizione 1 cassetto
structure 60 + drawer



FASTER KIUB

struttura 60 composizione piani
structure 60 + shelves



FASTER KIUB

struttura 60 composizione con griglia
structure 60 + grate shelf



FASTER KIUB

struttura 80 - composizione 1 cassetto + piano
structure 80 + drawer + shelf



ARTICOLO KSC60 - LAVABO ESCLUSO / WASHBASIN NOT INCLUDED	euro
FINITURE DISPONIBILI	1070
110 rovere rustico rustic oak	
111 abete scuro spruce	
112 cemento scuro concrete	

ARTICOLO KSP60 - LAVABO ESCLUSO / WASHBASIN NOT INCLUDED	euro
FINITURE DISPONIBILI	670
110 rovere rustico rustic oak	
111 abete scuro spruce	
112 cemento scuro concrete	



ARTICOLO KSG60 - LAVABO ESCLUSO / WASHBASIN NOT INCLUDED	euro
	780

ARTICOLO KSCP80 - LAVABO ESCLUSO / WASHBASIN NOT INCLUDED	euro
FINITURE DISPONIBILI	1100
110 rovere rustico rustic oak	
111 abete scuro spruce	
112 cemento scuro concrete	

FASTER KIUB

struttura 80 - composizione 1 cassetto + griglia
structure 80 + drawer + grate shelf





ARTICOLO KSCG80	LAVABO ESCLUSO / WASHBASIN NOT INCLUDED	euro
FINITURE DISPONIBILI	 110 rovere rustico rustic oak  111 abete scuro spruce  112 cemento scuro concrete	1200

FASTER KIUB

struttura 80 - composizione con piani
structure 80 + shelves





ARTICOLO KSP80	LAVABO ESCLUSO / WASHBASIN NOT INCLUDED	euro
FINITURE DISPONIBILI	 110 rovere rustico rustic oak  111 abete scuro spruce  112 cemento scuro concrete	720

FASTER KIUB

struttura 100 composizione 1 cassetto + piano
structure 100 + drawer + shelf





ARTICOLO KSCP100	LAVABO ESCLUSO / WASHBASIN NOT INCLUDED	euro
FINITURE DISPONIBILI	 110 rovere rustico rustic oak  111 abete scuro spruce  112 cemento scuro concrete	1170

FASTER KIUB

struttura 100 composizione 1 cassetto + griglia
structure 100 + drawer + grate shelf



ARTICOLO KSCG100	LAVABO ESCLUSO / WASHBASIN NOT INCLUDED	euro
FINITURE DISPONIBILI	 110 rovere rustico rustic oak  111 abete scuro spruce  112 cemento scuro concrete	1250

FASTER KIUB

struttura 100 composizione con piani
structure 100 + shelves





ARTICOLO KSP100	LAVABO ESCLUSO / WASHBASIN NOT INCLUDED	euro
FINITURE DISPONIBILI	 110 rovere rustico rustic oak  111 abete scuro spruce  112 cemento scuro concrete	780

FASTER KIUB

struttura 120 composizione 2 cassetti
structure 120 + two drawers



ARTICOLO KS2C120	LAVABO ESCLUSO / WASHBASIN NOT INCLUDED	euro
FINITURE DISPONIBILI	 110 rovere rustico rustic oak  111 abete scuro spruce  112 cemento scuro concrete	1650

FASTER KIUB

struttura 120 composizione 1 cassetto + piani
structure 120 + drawer + shelves



ARTICOLO KSCP120	LAVABO ESCLUSO / WASHBASIN NOT INCLUDED	euro
FINITURE DISPONIBILI	 110 rovere rustico rustic oak  111 abete scuro spruce  112 cemento scuro concrete	1250

FASTER KIUB

struttura 120 composizione cassetto + griglia
structure 120 + drawers + grate shelf



ARTICOLO KSCG120	LAVABO ESCLUSO / WASHBASIN NOT INCLUDED	euro
FINITURE DISPONIBILI	 110 rovere rustico rustic oak  111 abete scuro spruce  112 cemento scuro concrete	1300

FASTER KIUB

asta laterale porta asciugamano cm 44
wash basin towel holder lateral side cm 44



ARTICOLO KIP44 - LAVABO ESCLUSO / WASHBASIN NOT INCLUDED	euro
	95

FASTER KIUB

asta frontale porta asciugamano cm 59
towel holder front side cm 59 for wash
basinKI60/KI100DX/KI100SX/KI120/
KI120DV



ARTICOLO KIP59 -LAVABO ESCLUSO / WASHBASIN NOT INCLUDED	euro
	120



GIÒ EVOLUTION

LAVABI

G40E

60X40 cm



G42E

Ø 42



G43E

40X40 cm



G60E

60X40 cm





GIÒ EVOLUTION

Giò è una collezione concreta, pragmatica che si collega al meglio all'interno di tutte le tipologie di stanza da bagno grazie alla sua eleganza e sobrietà. La collezione è caratterizzata da un corretto e non banale utilizzo di curve e linee rette, quindi ad un ottimo bilanciamento di morbidezza e rotondità.

Giò is a concrete collection, thanks to its pragmatic and elegant simplicity it is connected to all types of bathroom. The collection is characterized by a proper and non-trivial use of curves and straight lines, so to a good balance of softness and roundness.





100
CEPPPO DI GRE' - GREY

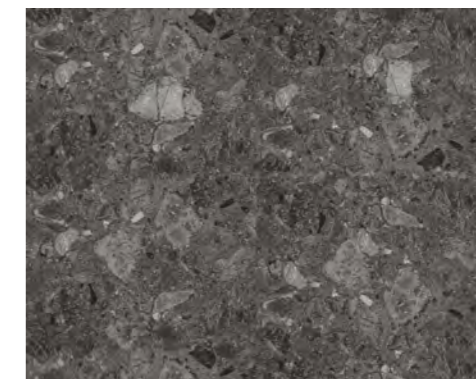

099
CEPPPO DI GRE' - DARK



101
WHITE MATT MARBLE

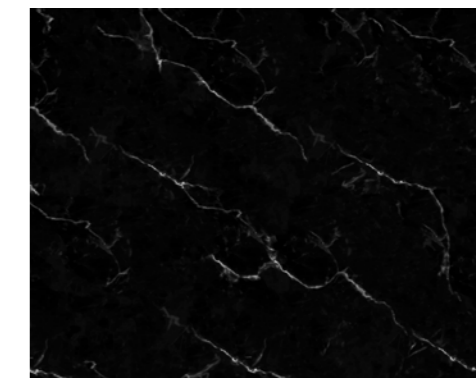

102
BLACK MATT MARBLE

Le finitura e i colori presenti sono indicativi, soggetti a processi di stampa.
The finishings and colours here indicative because subject to printing processes.

GIÒ EVOLUTION DECORATI



014
BIANCO/PLATINO
white/platinum



063
BIANCO/ORO ROSA
white/rose gold



020
NERO/ORO
black/gold



013
BIANCO/ORO
white/gold

Giò Evolution lavabi da appoggio si possono scegliere anche nelle versioni decorate: bianco/oro, nero/oro, bianco/platino, bianco/oro rosa, bianco/nero.
Giò Evolution countertop wash basins you can also choose the decorated versions as: white / gold, black / gold, white / platinum, white / rose gold, white/black.

GIÒ EVOLUTION

lavabo rettangolare appoggio
rectangular countertop washbasin

Accessori disponibili non inclusi/
Available accessories not included
art.P85 - P90- P125



ARTICOLO G40E — 13 kg 20 pz pallet Italia 42 pz pallet Export		euro
BIANCO LUCIDO	001 bianco lucido white	240
TEXTURE DISPONIBILI	100 ceppo di gré grey 99 ceppo di gré dark 101 white matt marble 102 black matt marble	500
DECORI DISPONIBILI	013 bianco/oro white/gold 014 bianco/platino white/platinum 063 bianco/oro rosa white/rose gold	610
DECORO NERO/ORO	020 nero/oro black/gold	730

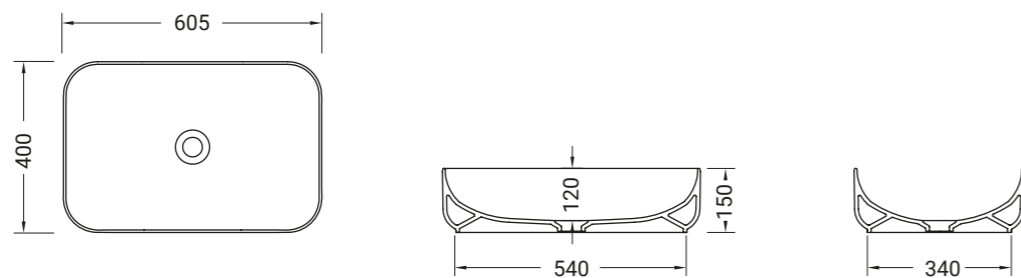

GIÒ EVOLUTION

lavabo tondo appoggio
round countertop washbasin

Accessori disponibili non inclusi/
Available accessories not included
art.P85 - P90- P125



ARTICOLO G42E — 7,5 kg 34 pz pallet Italia 60 pz pallet Export		euro
BIANCO LUCIDO	001 bianco lucido white	220
TEXTURE DISPONIBILI	100 ceppo di gré grey 99 ceppo di gré dark 101 white matt marble 102 black matt marble	480
DECORI DISPONIBILI	013 bianco/oro white/gold 014 bianco/platino white/platinum 063 bianco/oro rosa white/rose gold	550
DECORO NERO/ORO	020 nero/oro black/gold	660

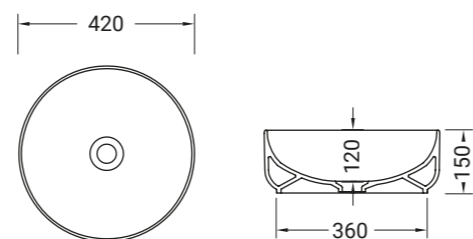

GIÒ EVOLUTION

lavabo ovale appoggio
oval countertop washbasin

Accessori disponibili non inclusi/
Available accessories not included
art.P85 - P90- P125



ARTICOLO G60E — 14 kg 20 pz pallet Italia 42 pz pallet Export		euro
BIANCO LUCIDO	001 bianco lucido white	240
TEXTURE DISPONIBILI	100 ceppo di gré grey 99 ceppo di gré dark 101 white matt marble 102 black matt marble	500
DECORI DISPONIBILI	013 bianco/oro white/gold 014 bianco/platino white/platinum 063 bianco/oro rosa white/rose gold	610
DECORO NERO/ORO	020 nero/oro black/gold	730

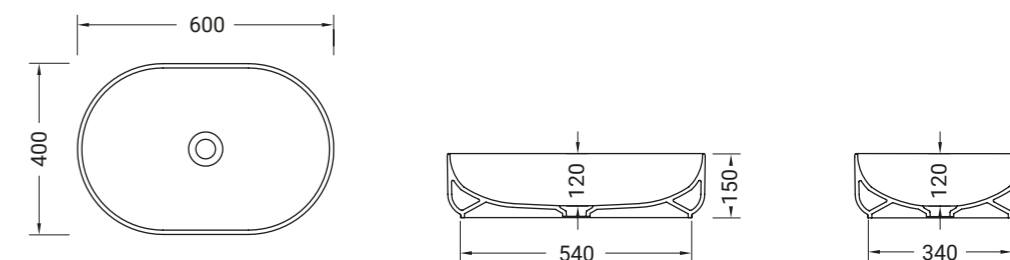

GIÒ EVOLUTION

lavabo quadro appoggio
squared countertop washbasin

Accessori disponibili non inclusi/
Available accessories not included
art.P85 - P90- P125



ARTICOLO G43E — 9,5 kg 34 pz pallet Italia 60 pz pallet Export		euro
BIANCO LUCIDO	001 bianco lucido white	220
TEXTURE DISPONIBILI	100 ceppo di gré grey 99 ceppo di gré dark 101 white matt marble 102 black matt marble	480
DECORI DISPONIBILI	013 bianco/oro white/gold 014 bianco/platino white/platinum 063 bianco/oro rosa white/rose gold	550
DECORO NERO/ORO	020 nero/oro black/gold	660

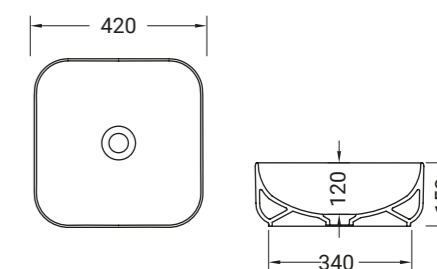

Condizioni generali di vendita

DISPOSIZIONI GENERALI

Le presenti condizioni di vendita e di consegna si intendono integralmente accettate dal Committente con il conferimento dell'ordine o con il ritiro dei materiali. Vengono respinte le eventuali condizioni generali di contratto del Compratore.

ACCETTAZIONE ORDINI

Gli ordini sono da intendersi subordinati all'accettazione di Hydra Ceramica Srl.

PREZZI

I prezzi possono essere variati senza nessun preavviso e si intendono pattuiti secondo i listini in vigore al momento della consegna. I prezzi contenuti nel presente listino sono da intendersi franco fabbrica e IVA esclusa.

PAGAMENTO

I termini di pagamento si intendono tassativi e decorrono dalla data di fatturazione. I pagamenti devono essere effettuati direttamente ad Hydra Ceramica Srl presso la sua sede. Qualsiasi ritardo imputabile al Committente o qualsiasi contestazione sorgesse fra le parti, anche relativamente alle garanzie concesse, non produrrà alcun prolungamento o modifica nei termini dei pagamenti convenuti ed ogni azione ed eccezione del Committente non sarà ritenuta procedibile, se lo stesso non proverà di essere in regola coi pagamenti. Nel caso di mora in qualsiasi pagamento potranno essere sospese ed annullate le forniture in corso. Decorso il termine di pagamento stabilito in fattura senza che ne sia avvenuto il regolamento, Hydra Ceramica Srl avrà la facoltà di emettere tratta a vista per l'ammontare dell'intero credito aumentato delle spese. L'eventuale ritardo nel pagamento comporterà l'addebito di interessi al tasso corrente di mercato, aumentato del 2%. Nel caso di inosservanza di uno dei termini di scadenza anche tutte le altre fatture del venditore saranno immediatamente esigibili. L'esigibilità di tutte le fatture si verifica anche nell'ipotesi in cui il venditore venga a conoscenza di altre circostanze che lascino temere una cattiva situazione finanziaria del compratore (per esempio: emissione di assegni scoperti, cambiali protestate, procedimenti di sequestro, ecc.)

TERMINI DI CONSEGNA, RITARDI O IMPEDIMENTI DI FORNITURA

Allorché viene indicato un termine di consegna, questo ha valore semplicemente informativo e non impegnativo, essendo subordinato a qualunque imprevisto. La consegna della merce si intende eseguita con la messa a disposizione della merce presso il nostro stabilimento di Civita Castellana (Italia). Interruzioni di lavoro conseguenti a cause di forza maggiore dispensano Hydra Ceramica Srl dall'osservare il termine di consegna indicato, senza peraltro dare diritto al Committente di esigere risarcimenti dovuti a danni di qualsiasi natura. La merce dovrà essere sempre ritirata dal Committente e non dovrà essere in ogni caso lasciata giacente. Le eventuali spese di giacenza, magazzinaggio, ecc. saranno comunque a carico del Committente.

TRASPORTO

Salve condizioni particolari, la merce è venduta franco nostro stabilimento ed in ogni caso viaggia a rischio e pericolo del Committente anche se resa franco destino. Sono consentite forniture parziali e anticipate. Il trasporto è a carico del Committente. Le spedizioni avvengono per conto ed incarico del Committente, il quale, in caso di avarie, rotture o ammanchi, deve notificarlo alla nostra azienda, tramite il vettore, al momento della consegna. La merce consegnata rimane di riservato dominio della venditrice fino all'avvenuto pagamento. I termini di consegna si intendono sempre indicativi ed in relazione alle possibilità del momento. Non si assume nessuna responsabilità per ritardi o mancate consegne per fatti o atti indipendenti dalla nostra volontà ed eventuali richieste di risarcimento danni per ritardi di consegna non saranno accettati.

IMBALLAGGIO

L'imballaggio viene effettuato in pallets e retraibile. Il costo dell'imballaggio è a carico del Committente, salvo patto contrario risultante dalla conferma d'ordine. A parziale recupero delle spese di imballo viene addebitato il 3%.

RESPONSABILITA'

Qualora il materiale risultasse difettoso per vizi di fabbricazione riconosciuti a seguito di accertamenti tecnici, Hydra si riserva di sostituirlo o accreditare il valore nei tempi previsti dalla Normativa vigente . In alcun caso la responsabilità può estendersi ai danni diretti e indiretti che dovessero derivare anche dalla messa in opera del materiale difettoso. E' fatto onere al compratore di controllare ogni articolo non appena preso in consegna, e così in particolare di aprire le confezioni, gli imballaggi e le scatole di contenimento; il termine decadenziale di legge per i vizi evidenti decorre dal momento della consegna stessa.

RECLAMI

Non si accettano reclami di nessun genere trascorsi otto giorni dal ricevimento della merce. Eventuali reclami dovranno essere fatti a mezzo lettera raccomandata entro tale termine. In ogni caso nessuna contestazione verrà accettata per materiali già posti in opera.

CARATTERISTICHE TECNICHE E COLORI

Hydra Ceramica Srl si riserva la facoltà di modificare le caratteristiche al fine di migliorare tecnicamente ed esteticamente il prodotto o sospendere la produzione dei modelli in qualsiasi momento senza preavviso. Pesi e misure sono da considerarsi indicativi. Le misure di installazione, riportate nei cataloghi, possono presentare differenze rispetto ai pezzi reali in considerazione delle peculiari caratteristiche di fabbricazione degli articoli in ceramica

FORO COMPETENTE

Qualsiasi controversia fra Hydra Ceramica Srl e il Committente sarà di competenza soltanto del Foro di Viterbo (Italia), esclusa qualsiasi altra deroga, anche nel caso di chiamata in giudizio per garanzia, connessione, contigenza di lite.

General sales conditions

GENERAL CONDITIONS

The present conditions of sale and delivery are considered as fully accepted by the Purchaser upon the order or the collection of the goods. Any general conditions of sale of the Purchaser are rejected.

ACCETTAZIONE ORDINI

The orders are anyway subject to the prior consent of Hydra Ceramica Srl.

PRICES

Prices may be charged without notice and are agreed according to the price list in force on delivery. The prices of the present price list are meant ex factory and don't include V.A.T.

PAYMENT

Payment terms must be strictly respected starting from the invoice date. Payments should be made directly to Hydra Ceramica Srl at its headquarter. Any delay caused by the Purchaser or should any dispute arise between the parties as to the guarantees granted will not result in an extension or change of the terms of payment agreed upon and any Purchaser's action and exception will not be considered as prosecutable if the Purchaser does not prove to be up-to-date with his payments. In case of delay in any payment the supplies under way may be interrupted or cancelled. If no payments has been received within the terms set up in the invoice, Hydra Ceramica Srl will be authorized to issue a sight draft for the total amount of its credit plus the relevant expenses. Any possible delay in the payment will result in the charge of interest at the market current rate plus 2%. In case of failure to meet one of the payment dates the seller will be entitled to demand immediate payment of all other invoices. Payment of all the invoices may also be demanded if the seller receives information about others circumstances which may indicate that the purchaser's financial situation is not sound (for example: issue of bouncing cheques, protested bills of exchange, attached proceeding).

DELIVERY TERMS, DELAYS OR OBSTACLES IN SUPPLY

When a delivery terms is stated, such term is given only for information purpose and is not binding since it is subject to any kind of contingency. Delivery is considered as being completed when the goods are available at our factory in Civita Castellana (Italy). Work stoppage resulting from act of God will exempt Hydra Ceramica Srl from the observance of the delivery term stated without giving the Purchaser the right to claim for any kind of damages. The goods shall always be collected and shall not remain in stock for any reason. Any stock or storage expenses or other costs will be charged to the Customer.

CARRIAGE

Except for particular condition, goods are delivered ex factory and travel at Purchaser's risk even when they are delivered free port of destination. Partial supplies and early supply are permitted. The cost of transport is at Customer charge. Shipment are made on behalf of the buyer. In case of damages, breakages and shortages, the buyer has to notify to our firm through the carrier at the moment of the delivery. The supplier is the owner of the delivered goods up to the due payment. Terms of delivery are subject to variations and depending to the possibilities of the moment. Our firm is not responsible for any delay or missing deliveries caused by any facts independent of our will and any claim for reimbursement for any delay that may occur in delivery will not be accepted.

PACKAGING

The packaging is made in pallets and shrink. The cost of the packaging is charged to the Purchaser, unless otherwise agreed upon as specified in the order confirmation. We charge of 3% for freights of packaging.

LIABILITY

If the material is defective due to manufacturing defects recognized by technical assessments, Hydra reserves the right to replace or to credit the value in the time required by law. In no event shall the liability can extend to any direct or indirect which might arise also from the installation of the defective material. It is burden of the buyer to check every item as soon as received, and so in particular to open the packaging and boxes of containment; the period of revocation of law for defects apparent begins at the time of delivery thereof.

COMPLAINS

No complain of any kind will be accepted after eight days from the receipt of the goods. Possible complains should be made through a registered letter within such term. In any case no objection will be accepted for already installed material.

TECHNICAL FEATURES AND COLORS

Hydra Ceramica Srl reserves the right to change the features of its products in order to improve them from the technical and aesthetic viewpoint or to interrupt the production of certain models in any time without notice. Weight and measures are given only for information purposes. Discrepancies may be found between the dimensions shown in the catalogues and the real pieces because of the manufacturing characteristics of the articles in ceramic.

COMPETENT COURT

Any dispute between Hydra Ceramica Srl and the Purchaser will be settled only by the Court of Viterbo (Italy), with no exception to such rule, even in case of summons for guarantee, consolidation of actions or lawsuit contingency

5151

HIDRA
CERAMICA

PRODOTTI COLORATI – DECORATI / COLORED & DECORATED PRODUCTS

MADE IN ITALY

PRODOTTI COLORATI - DECORATI

I decori sono realizzati a mano con tecniche artigianali, quindi eventuali imperfezioni non possono essere motivo di contestazione. Tali caratteristiche fanno del prodotto da Voi acquistato un pezzo assolutamente unico ed irripetibile.

CURA E PULIZIA DEI PRODOTTI

Si avverte la Spettabile clientela che l'uso di detersivi, abrasivi e caustiche di ogni genere nella pulitura dei nostri prodotti decorati, possono seriamente comprometterli. Si consiglia pertanto, per una lunga durata del prodotto, di usare quotidianamente solo alcol denaturato e asciugare con un panno morbido. HIDRA declina ogni responsabilità derivata dall'eventuale inadempienza di dette istruzioni.

COLORED - DECORATED PRODUCTS

The decorations are handmade employing artisanal techniques in shape or in the glaze may not give rise to any sort of claim. Such characteristics make the products purchased absolutely unique and unrepeatable.

CLEANING AND CARE PRODUCTS

Do not use cleaning agents such as detergents, abrasives and caustic during the cleaning of our decorated products. These cleaning aggressive agents can damage them. We recommend a daily cleaning by means a soft cloth with denatured alcohol only, for a long life of your product.

HIDRA cannot assume responsibility for inobservance of said instructions.

HIDRA CERAMICA SRL
VIA FALERINA 31/E - CIVITA CASTELLANA 01033 - ITALY +39.0761.518181 info@hidra.it
WWW.HIDRA.IT



HIDRA Ceramica S.r.l

Via Falerina 31 E
01033 Civita Castellana (VT) Italy

Tel. (+39) 0761 518181
Fax. (+39) 0761 517133

Mail. info@hidra.it/export@hidra.it

www.hidra.it



HIDRA
CERAMICA

HIDRA Ceramica S.r.l
Via Falerina 31 E
01033 Civita Castellana (VT) Italy
Tel. (+39) 0761 518181
Fax. (+39) 0761 517133
Mail. info@hidra.it
www.hidra.it