

# HIDRA



---

**e-catalogo/listino 2021**  
**e-catalogue/price list 2021**

# HIDRA

CERAMICA



   
MADE IN ITALY

Made in Italy è produzione originale, creativa e di qualità  
*Made in Italy is, original, creative and quality production*



# La nostra storia e i nostri valori

## *Our history and our values*

Hidra inizia la propria attività produttiva nel 1989 ed è oggi, una delle aziende italiane leader nella produzione di articoli sanitari e per l'arredo bagno.

Con impianti tecnologicamente all'avanguardia, con l'impegno costante nella ricerca e i continui investimenti in risorse umane, Hidra ha conseguito eccellenti standard qualitativi realizzando prodotti sempre in linea con le ultime tendenze del mercato. Le collezioni Hidra caratterizzate da qualità e attenzione al design vengono progettate e realizzate attraverso la collaborazione con noti designers.

Con l'obiettivo di raggiungere una sempre maggiore soddisfazione del cliente, la filosofia di qualità e design si amplia con il nuovo servizio che Hidra offre ai propri clienti: la possibilità di allestire i corner espositivi all'interno dei punti vendita con una comunicazione coordinata per i propri prodotti. I prodotti Hidra sono distribuiti uniformemente sul territorio nazionale e internazionale in ben 60 paesi.

EN

*Hidra began manufacturing its own products from 1989 and nowadays is one of the Italian leading producers of sanitary wares and bathroom furnishing.*

*Through a combination of state of the art technological systems, constant commitments to resources and continues investments in human resources, the company has delivered solutions of consistently exceptional standards, manufacturing products that always suit the most innovative trends of the demanding markets. Hidra collections are characterized by quality and attention to the design, they are designed and manufactured through the constant collaboration with famous designers. With the commitment of achieving an always more efficient service of customer care Hidra has extended its philosophy of quality and design providing with a new service which includes the design of special corners dedicated to Hidra products in sales points. Hidra is distributed throughout Italy and abroad in over than 60 countries.*



### know how

Il saper fare artigianale è alla base della nostra attività  
*Artisanal know how at the base of our activity.*

### ricerca

Soluzioni altamente tecnologiche per consentire il risparmio idrico  
*Top technological solution for water saving.*

### design

prodotti portatori di qualità, capaci di dettare mode e tendenze.  
*High quality and trend-setting products.*



1960

HIDRA  
CERAMICA

2020

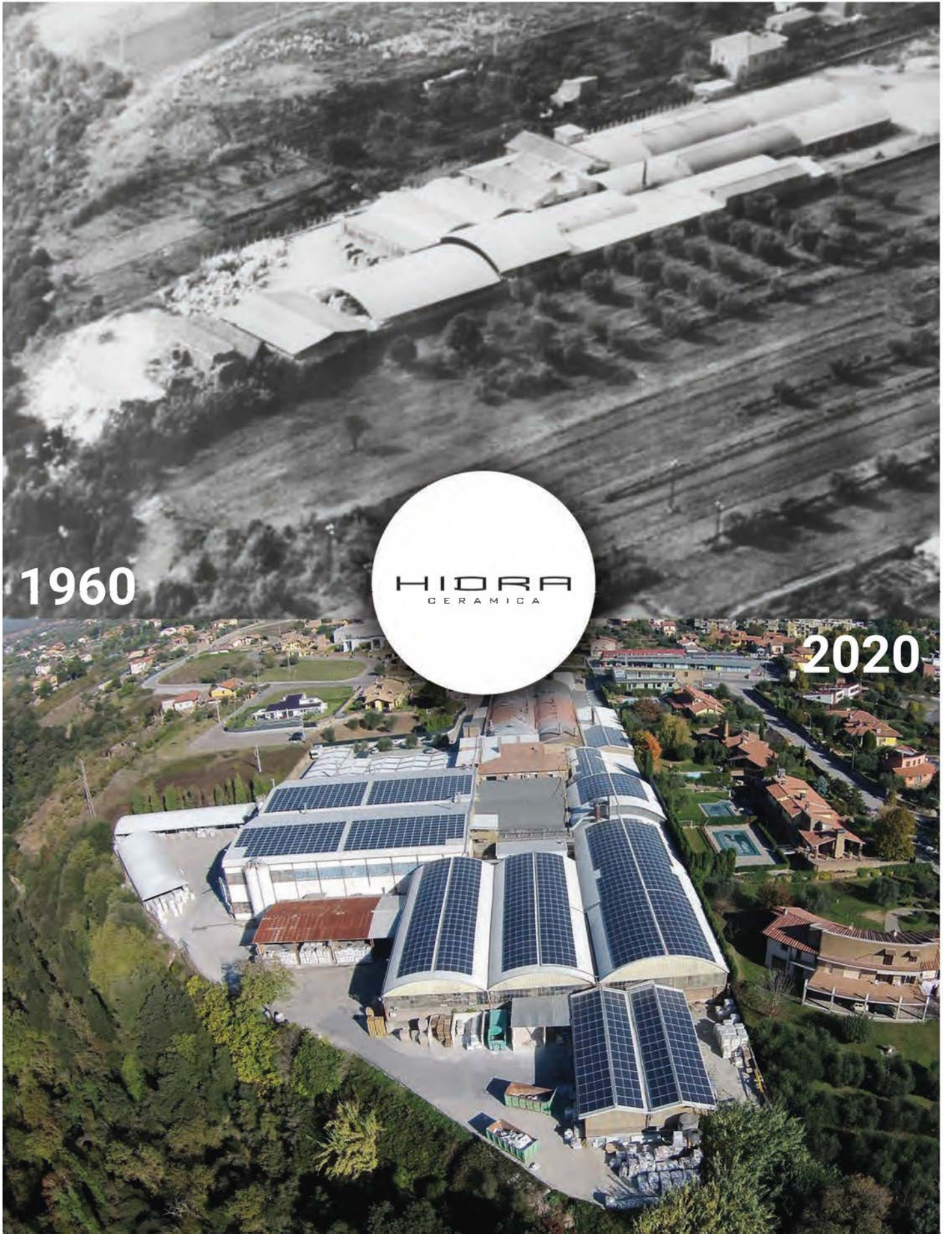



# Produzione: tradizione e innovazione

## *Production: tradition and innovation*

Il valore del Made in Italy, la responsabilità sociale e ambientale, la cura per i dettagli e valorizzazione delle relazioni umane sono i valori che Hidra pone al centro della sua filosofia aziendale e della sua strategia di crescita. Tutto è finalizzato alla realizzazione di prodotti di estrema qualità dalla ridefinizione delle linee di produzione, al miglioramento della qualità di vita dei lavoratori, fino all'utilizzo delle tecnologie più all'avanguardia e all'impiego di materie prime purissime per il risparmio idrico.

Design, cura delle lavorazioni manuali, ricerca tecnologica e bellezza convergono insieme per dare vita a prodotti durevoli capaci di rendere unico e di tendenza nell'ambiente bagno.

EN

*Value of the Made in Italy, social and environmental responsibility, care for the detail and enhancement of human relationship are, the values that Hidra places at the heart of its business philosophy and grown strategy. Everything is aimed at the creation of products of the highest quality from the redefinition of products lines, improving the quality of life of workers, up to use of the most cutting-edge technologies and the use of pure raw materials for water saving.*

*Design, care of the handmade, technological research and beauty converge together to give life and durable products capable of making unique and trendy products in the bathroom environment.*





metri quadrati di superficie  
su cui si sviluppa l'azienda

*square meters area*

**20.000 mq**



metri quadrati di spazio  
espositivo aziendale

*square meters showroom*

**200 mq**



prodotti a catalogo

*products on catalogue*

**250**



prodotti Made in Italy

*Made in Italy products*



certificazione qualità ISO 9001

*ISO9001 quality certified*

---

**HIDRA**  
CERAMICA



Reg. Numero	766- A	Valido da	2018-12-19
Primo rilascio	1999-03-25	Ultima modifica	2018-12-19
Scadenza	2021-12-11	Settore IAF	15

## Certificato del Sistema di Gestione per la Qualità **ISO 9001:2015**

Si dichiara che il sistema di gestione per la Qualità dell'Organizzazione:

### **HIDRA CERAMICA S.r.l.**

è conforme alla norma UNI EN ISO 9001:2015 per i seguenti prodotti/servizi:

Progettazione e fabbricazione di articoli sanitari in Vitreous China e Fire Clay

Chief Operating Officer  
Giampiero Belcredi

Il mantenimento della certificazione è soggetto a sorveglianza annuale e subordinato al rispetto dei requisiti contrattuali di Kiwa Cermet Italia.

Il presente certificato è costituito da 1 pagina.

Kiwa Cermet Italia S.p.A.  
Società con socio unico,  
soggetta all'attività di  
direzione e coordinamento di  
Kiwa Italia Holding Srl  
Via Cadrano, 23  
40067 Granarolo dell'Emilia  
(BO)  
Tel +39.051.459.3111  
Fax +39.051.763.382  
E-mail: info@kiwacermet.it  
www.kiwa.it

**CERMET**

### **HIDRA CERAMICA S.r.l.**

#### **Sede Legale**

- Via Falerina 31/e 01033 Civita Castellana (VT) Italia

#### **Sedi Oggetto di Certificazione**

- Via Falerina 31/e 01033 Civita Castellana (VT) Italia



SGQ N° 007A  
SGA N° 010D  
PRD N° 069B  
FSM N° 004I  
PRS N° 089C







## Made in Italy

Ogni prodotto è studiato, concepito e realizzato interamente in Italia con un design ricercato e un'attenzione al particolare per rendere unico e speciale l'ambiente bagno.

Hidra è una realtà in continua evoluzione con uno sguardo rivolto al futuro e alla continua innovazione, nell'ottica di portare un crescente miglioramento attraverso la qualità e la cura che contraddistingue ogni prodotto da circa 30 anni. Il valore del Made in Italy si manifesta nell'ampia proposta di prodotti di qualità caratterizzati da un design unico che coniuga eleganza ed un perfetto comfort di utilizzo.

EN

*Each product we manufacture is conceived and produced entirely in Italy with a refined design and a particular care to make the bathroom area unique and special.*

*Hidra is an ever-evolving company with a look at the future and a continuous innovation for increasing improvement through quality and care that characterized our production over the past 30 years. The "Made in Italy" value can easily be seen through the wide range of high quality products which are conceived with a unique design that combines elegance, comfort and functionality.*



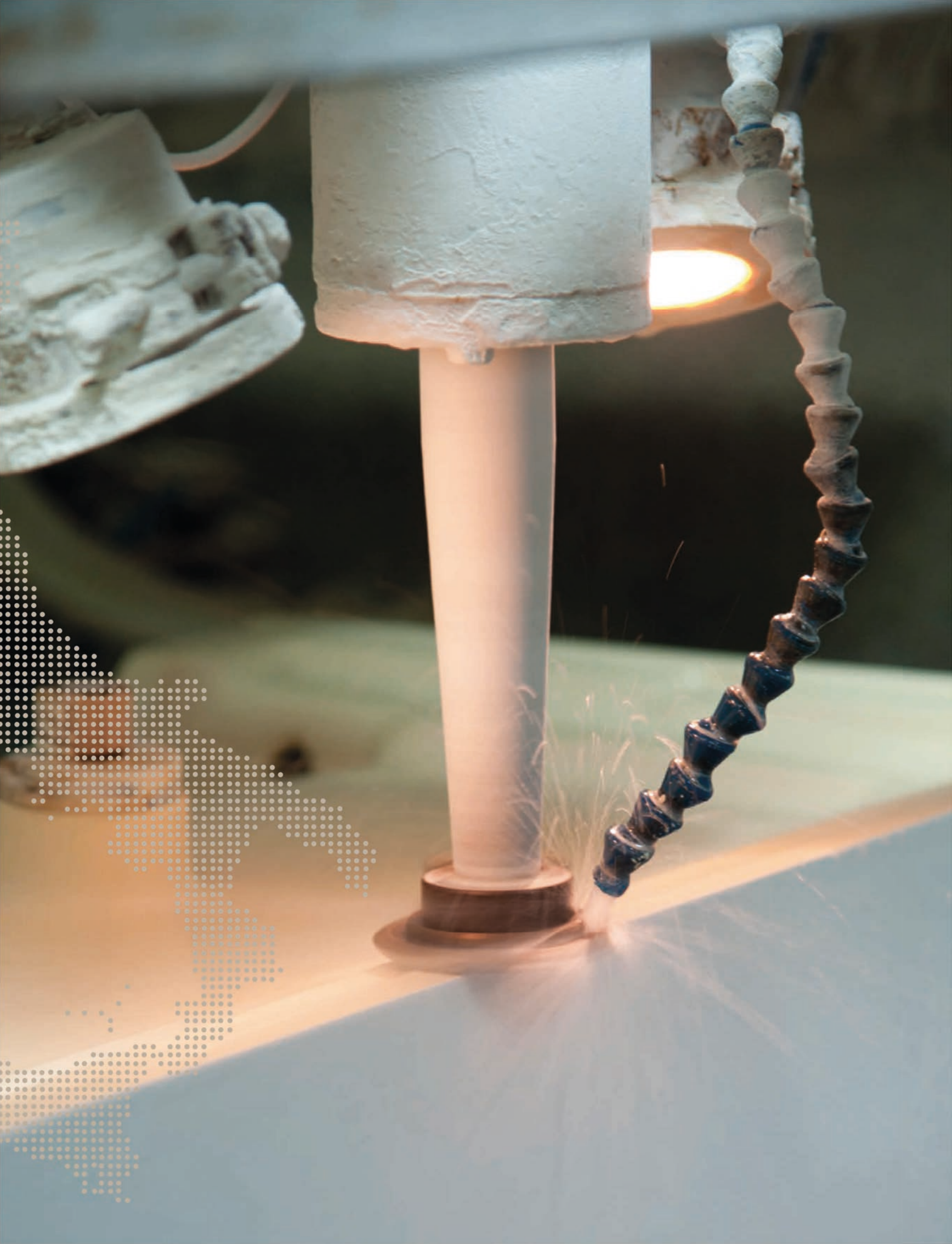





## GREEN COMPANY : Il rispetto per il territorio

La sensibilità nei confronti dell'emergenza ecologica mondiale ha spinto Hidra a porre l'ambiente al centro delle sue politiche economiche, sociali e industriali.

Hidra è un'azienda sostenibile, nel suo ruolo di industria e nel suo rapporto con il territorio che la ospita. Le unità produttive si inseriscono in modo armonico nel distretto delle ceramiche di Civita Castellana, un luogo dove la natura è considerata una ricchezza ed un patrimonio da rispettare e valorizzare. Tale volontà si concretizza con l'installazione di un notevole impianto fotovoltaico che permette di utilizzare energia pulita, così come le diverse scelte impiantistiche che consentono all'azienda di avere un minore impatto sull'ambiente.

*Due to the worldwide ecological emergency, Hidra has as its main social, industrial and economic focus on the respect for the environment.*

*Hidra is a sustainable company that respect the local territory where it is actually based. Our production plants are perfectly harmonized and contextualized in the territory of Civita Castellana where the naturalistic environment is considered as a social wealth to respect and valorized. All this has been achieved through the installation of a high-technological photovoltaics that allows the use of clean energy and a soft impact on the environment thanks to particular installations in production plants.*





**TRASFORMIAMO I RIFIUTI  
IN UNA RISORSA  
WE TRANSFORM WASTE  
INTO A RESOURCE**

Con il riciclo abbiamo aperto a nuove possibilità per la produzione sostenibile e per l'economia dell'azienda.  
*Using a recycling system we experienced new possibilities for a sustainable production and the economy of our company.*



**USO DI IMBALLAGGI  
CON PLASTICA RICICLATA  
WE USE HEAT-SHRINKING  
WRAPPINGS FROM RECYCLED  
PLASTIC MATERIAL**

Qualità, etica e ambiente definiscono il nostro business e il loro rispetto è certificato secondo norme e standard internazionali. Per la sicurezza di tutti.  
*Quality, ethics and respect for the environment are at the core of our business and all this is certified according to international standards and rules.*



**USO DI IMBALLAGGI  
CON CARTA RICICLATA  
WE USE CARTON BOXES  
FROM RECYCLED PAPER**

Rendiamo infinita la materia prima. La carta viene rigenerata e reimpressa sul mercato in nuovi prodotti.  
*Raw material becomes infinite. Paper is recycled and re-introduced on the market through new products.*



**NEL FUTURO DI CHI SCEGLIE  
IL FUTURO DEL PIANETA  
WE ARE WITH THOSE WHO CARE  
ABOUT THE EARTH FUTURE**

Condividiamo l'impegno dell'Agenda Globale. Sviluppiamo un'economia circolare. Integriamo il business con la mitigazione dell'ambiente.  
*We share the commitments of the Global Agenda and develop a circular economy. Our business and respect for the environment go hand in hand.*



**PRODUZIONE DEL 40% DI ENERGIA  
ELETTRICA NECESSARIA  
CON PANNELLI FOTOVOLTAICI  
WE PRODUCE 40% OF ELECTRICITY  
FOR OUR DAILY PRODUCTION  
THROUGH PHOTOVOLTAICS**

Un impegno che diventa un metodo, capace di dare risultati immediati ma anche a lungo termine, perchè mirato alla massima sostenibilità.  
*A commitment that has become a sort of method for short and long-term results aimed at sustainability.*





## BONUS IDRICO 2021

CON LA LEGGE DI BILANCIO 2021 è stato istituito un "BONUS IDRICO" di **1.000** euro da utilizzare entro il 31 dicembre 2021.

Tale bonus sarà riconosciuto per le spese sostenute per:

a) *la fornitura e la posa in opera di vasi sanitari in ceramica con volume massimo di scarico uguale o inferiore a 6 litri e relativi sistemi di scarico, compresi le opere idrauliche e murarie collegate e lo smontaggio e la dismissione dei sistemi preesistenti;*

b) *la fornitura e l'installazione di rubinetti e miscelatori per bagno e cucina, compresi i dispositivi per il controllo di flusso di acqua con portata uguale o inferiore a 6 litri al minuto, e di soffioni doccia e colonne doccia con valori di portata di acqua uguale o inferiore a 9 litri al minuto, compresi le eventuali opere idrauliche e murarie collegate e lo smontaggio e la dismissione dei sistemi preesistenti.*

**HIDRA**  
GREEN COMPANY

La sensibilità nei confronti dell'emergenza ecologica mondiale ha spinto HIDRA a porre l'ambiente al centro delle sue politiche economiche, sociali e industriali.

Già da diversi anni la HIDRA ha tra i propri obiettivi ambientali, quello del **risparmio idrico** adottando sia innovazioni nel proprio processo produttivo che **progettando prodotti** a basso consumo di acqua.

**TUTTI I NOSTRI VASI  
RIENTRANO NEL REQUISITO  
STABILITO DALLA  
LEGGE DI BILANCIO 2021  
E QUINDI  
IDONEI ALL'OTTENIMENTO  
DEL BONUS IDRICO.**

[WWW.HIDRA.IT](http://WWW.HIDRA.IT)



**Riutilizzo di acque industriali**  
Reuse of all industrial water



**Riutilizzo di acqua piovana**  
Reuse of rainwater



**Rispetto per l'ambiente**  
Respect for the environment

# Risparmio d'acqua: come riduciamo il consumo d'acqua

## Save water: how we reduce the water in our flushing system

Qualità, etica e ambiente definiscono la nostra visione aziendale.

Tra le scelte green che interessano la nostra fase produttiva ha un'importanza chiave il rispetto e l'impiego di materiali naturali e riciclati, in primis il risparmio e il riutilizzo delle acque industriali e dell'acqua piovana. L'impiego di energia pulita e rinnovabile è una parte integrante del processo produttivo e segue di pari passo anche quello progettuale in quanto tutti i vasi Hidra scaricano 4,5/3lt permettendo un risparmio di molti litri di acqua al giorno.

*Quality, ethics and respect for the environment are at the core of our company vision. Our "green" conception, especially in the manufacturing process, can be found in the use of natural and recycled materials like the reuse of industrial and rain water. The use of renewable and clean energy is an important feature both of our manufacturing process and of our planning stage, feature that can be seen in the water-saving flushing system of our Wc (4.5/3Lt) that allows to save around 10 cubic meters of water a day.*



**9** litri d'acqua generalmente utilizzati  
*It standard water flushing*



**6** litri d'acqua richiesti dalle normative europee  
*It flushing required by the European rules*



**4** litri d'acqua utilizzati dai nostri WC  
*It our reduced water flushing system*



**Risparmio d'acqua costante**  
Continuos water saving



**Produzione del 40% di  
energia elettrica con pannelli  
fotovoltaici** / 40% electricity  
production with photovoltaic  
panels



**Tutti i nostri vasi scaricano  
a 4,5/3 lt** / All our toilets  
discharge 4,5/3 litres of  
water



# L'innovativo smalto antibatterico

## Antibacterial glaze

I nostri sanitari garantiscono un ridotto deposito di calcare grazie ad un efficace smalto antibatterico. Si tratta di un trattamento superficiale in grado di svolgere un'azione antimicrobica che previene la formazione di germi e batteri, facilitando così la pulizia dei sanitari.

EN

*Our sanitary wares guarantee a reduction of limestone deposit, thanks to an efficient antibacterial glaze. This process on the surface of the glaze plays an antimicrobial action that prevents the formations of germs and bacteria, making the cleaning of the sanitary wares easier.*



**Igiene più profonda**  
*Deeper hygiene*



**Colore brillante**  
*Brighter colour*



**Resistente alle  
sostanze chimiche**  
*Resistance to  
chemical agents*

## Caratteristiche del prodotto

*Product features*



**Maggiore brillantezza**  
Brightness



**Pulizia facile e rapida**  
Quick cleaning



**Rispetto per l'ambiente**  
Respect for the environment



**Igiene totale**  
Total hygiene



**Maggiore resistenza  
agli agenti chimici**  
Resistance to chemicals

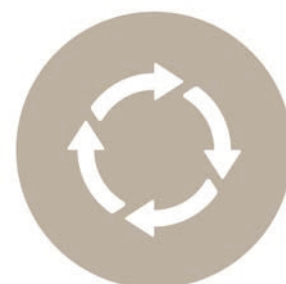

**Lunga durata di vita**  
Long lifecycle



## Effetti Pietra & Marmo

### “Effetto Pietra e Marmo”

Le finiture Pietra & Marmo”, prendono ispirazione dall’esclusiva pietra naturale del nord Italia chiamata Ceppo di grè.

Utilizzando tecniche di lavorazione fatte interamente a mano e sviluppate in molti anni di esperienza, ad ogni pezzo viene applicata una decalcomania sulla parte della superficie smaltata bianca per ottenere l’effetto di grande risultato estetico in Pietra e Marmo.

La ricottura del pezzo ad oltre 900° permette la fusione della pellicola con il pezzo in ceramica. La resistenza e assorbimento dell’acqua è in accordo con le norme europee CE, come tutti i prodotti ceramici della Hidra.

La pulizia e cura del prodotto deve seguire le stesse istruzioni dei prodotti colorati o decorati, evitando l’uso di detergenti aggressivi, abrasivi o caustici. Per una lunga durata del prodotto, raccomandiamo una pulizia regolare del prodotto tramite l’uso di un panno morbido con alcol denaturato.

### “Stone & Marble effect”

*“Stone & Marble” finishings are, the latest HIDRA collection on special textures inspired by natural stones of North of Italy named “Ceppo di Grè”.*

*Using hand-made techniques developed in many years of experience, on each ceramic piece is wrapped a special decal film texture stretched around the area to obtain the stone & matt-marble effect with an outstanding aesthetic result.*

*During the process of firing, the temperature reach over 900° C, the decal blends in the ceramic glaze becoming a masterpiece.*

*The resistance and water absorption are in accordance to the European norms CE as all HIDRA ceramic products.*

*The cleaning and care of the products have to follow the same maintenance instruction for the matt Colored finishes, avoiding aggressive detergents, abrasive and caustic agents.*

*We recommend, for a long life of the products, a regular cleaning, using a soft cloth with denatured alcohol.*



---

## Decori Oro & Platino

### Processo produttivo Hydra Decori

Su tutti i prodotti decorati a mano in oro e Platino, applichiamo due tipi di sostanze liquide;

- Oro brillante 347/10 PM
- Platino brillante P17

Attraverso la ricottura al secondo fuoco si crea il processo termico necessario affinché queste sostanze liquide, producano un film metallico che corrisponde a 21,07 carati, diventando parte integrante del prodotto stesso.

### *Hydra Decors production process*

*On all Gold & Platinum decorated ceramic items, Hydra hand paint two kind of liquids substances;*

- *Brilliant liquid Gold 347/10 PM*
- *Brilliant liquid Platinum P17*

*Throught the second firing the liquids substances produce a metallic film of 21,07 carats to create unique and luxurious hand made Hydra items.*





## Hidra Designers



Sandro Meneghello e Marco Paoelli, entrambi classe 1979, si sono laureati al Politecnico di Milano nel 2004, sotto la guida di P.Rizzatto e R.Palomba. Collaborano con Hidra dal 2005 e la loro attività all'interno dell'azienda spazia dalla progettazione del prodotto alla sua comunicazione, nonché all'ideazione di stand per le fiere e di corner espositivi.

Carlo Urbinati nasce a Roma dove inizia l'attività nel campo del design e dell'arredamento, la sua preparazione tecnica abbinata alla sua passione per i materiali e le nuove tecnologie lo portano, negli anni 70, a prediligere il rapporto con aziende del settore bagno, con le quali condivide le prime sperimentazioni con nuovi materiali plastici.

EN

*Sandro Meneghello and Marco Paoelli, both born in 1979, graduated at the Politecnico di Milano, under the guidance of P.Rizzatto and R.Palomba. Since 2005 they have collaborated with Hidra, their work with the company ranges from product design and communication, to stand design and in-store display.*

*Carlo Urbinati was born in Rome, where began working in the field of design and furniture; his technical background and his passion for materials and new technologies led him, in the seventies to prefer a cooperation with companies in the bathroom business with which shared the first trials with new plastic materials.*





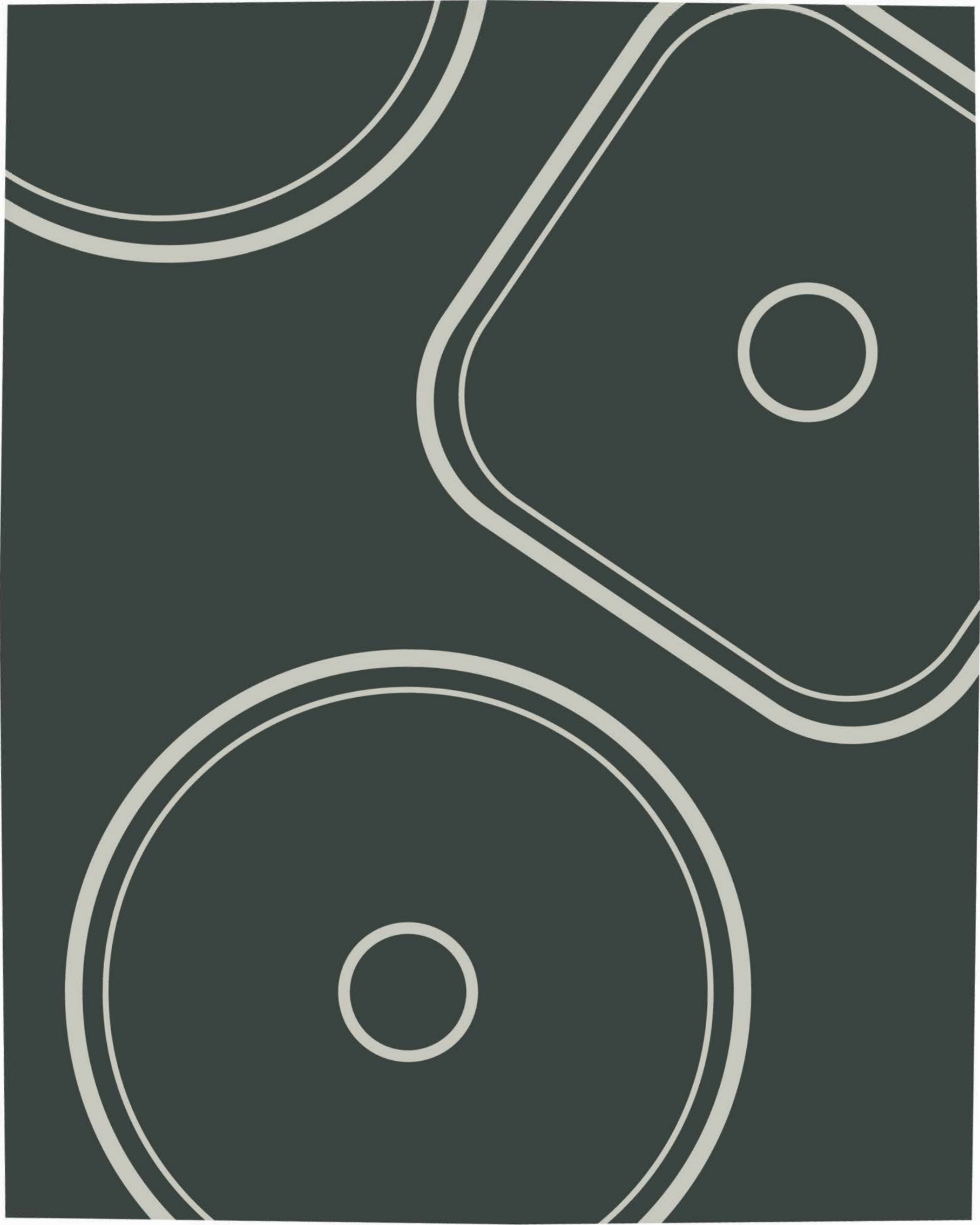

# INDICE

## INDEX

**ONE SHOT** p.25  
(Miss, Wire, Sphere, Drop)

**HI LINE** p.63

**ELLADE** p.83

**FASTER** p.117

**KIUB** p.133

**GIÒ EVOLUTION** p.163

**TOUR** p.191

**TOUR 4.0** p.201

**MY** p.209

**PIATTI DOCCIA** p.221

**LAVABI** p.229

**ACCESSORI** p.237





# ONE SHOT

**MISS  
WIRE  
HUB  
SPHERE  
DROP**





# MISS

MADE IN ITALY

**Superfici morbide, sinuose e avvolgenti caratterizzano Miss, lavabo d'arredamento centrostanza. La superficie frontale nasce dal basso generando un invito per i piedi e si sviluppa per tutta l'altezza del prodotto modellandosi a cucchiaio nel catino, con un unico movimento fluido e dinamico. Il lavabo centrostanza Miss è realizzato in Ictek light e prevede lo scarico a pavimento o a parete.**

*Smooth surfaces, sinuous and curvaceous depict Miss the freestanding washbasin. Miss is an extremely ergonomic product that compliments the human body whilst washing. The front surface emerges from the bottom welcoming the feet and it develops for all its height shaping like a spoon with a flowing and dynamic unique movement. Fabricated in Ictek light it supports wall or floor flush system.*





HIDRA — MISS

**MISS 578X58 H88**

lavabo centrostanza + sifone + piletta  
freestanding washbasin + siphon + drain



**ARTICOLO MI15** — 45 kg | 2 pz pallet Italia | 6 pz pallet Export

euro

BIANCO  
LUCIDO



**001**  
bianco lucido  
white shine

2700

COLORI  
DISPONIBILI



**009**  
nero lucido  
black shine

3600

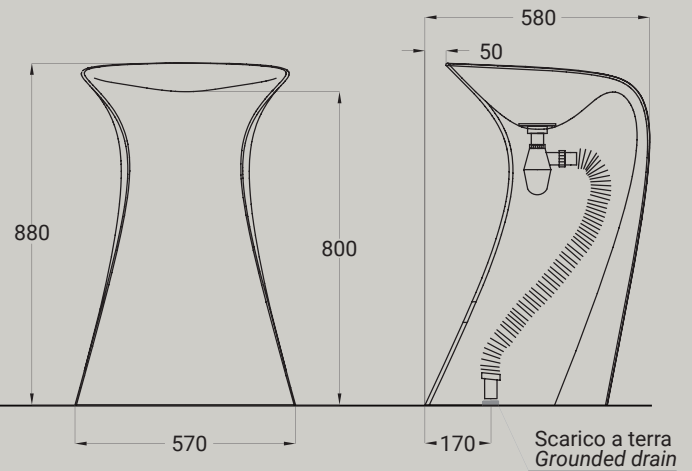

**COLORI  
COLORS**



bianco lucido  
white shine



nero lucido  
black shine



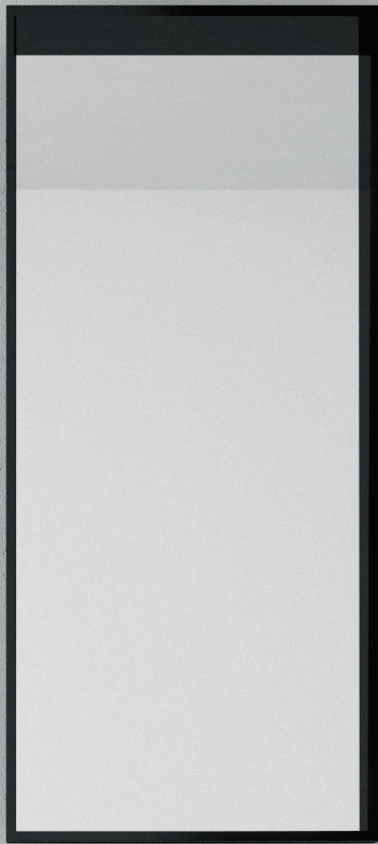





# WIRE

MADE IN ITALY

**Wire non è un classico lavabo mono-materico in ceramica, ma una composizione di due elementi distinti: la vasca, utilizzabile anche separatamente come lavabo d'appoggio, e la colonna portante, alleggerita dalla sua massa grazie ad una struttura di tondini metallici. La base è realizzata tramite la rivoluzione di 18 tondini che vengono percepiti come elementi sovrapposti, si ha così l'illusione ottica di una maglia.**

*Wire is not a one-piece freestanding washbasin, but a combination of two elements: the basin, that can be used as a countertop basin as well, and the column, made up from a circular array of 18 steel rods that gives the optical illusion of a meshwork.*



HIDRA — WIRE







HIDRA — WIRE

## WIRE Ø43

lavabo appoggio  
countertop washbasin



Accessori disponibili non inclusi/  
Available accessories not included  
art.P85 - P90 - P125

### FISSAGGIO

P85 - sistema fissaggio per lavabi appoggio Euro 10,00  
P85 - fixing kit for countertop washbasin Euro 10,00





### PILETTA



P90 - piletta flusso continuo per lavabo Euro 72,00  
P125 - piletta click-clack o fl usso continuo per lavabo con copertura  
in ceramica Euro 72,00

P90 - open outlet drain for washbasin Euro 72,00  
P125 - click-clack drain or open outlet drain for washbasin with  
ceramic cover Euro 72,00





**ARTICOLO W1** — 9,3 kg | 20 pz pallet Italia | 34 pz pallet Export euro

**BIANCO LUCIDO**  **001**  
bianco lucido  
white 240

**COLORI DISPONIBILI**  **006**  **026**  **009**  **097**  
bianco matt  
white matt nero matt  
black matt nero lucido  
black shine rosa matt  
pink matt 360

**DECORI DISPONIBILI**  **013**  **014**  **063**  
bianco/oro  
white/gold bianco/platino  
white/platinum bianco/oro rosa  
white/rose gold 650

**DECORO NERO/ORO**  **020**  
nero/oro  
black/gold 730

**TEXTURE DISPONIBILI**  **100**  **101**  **103**  **104**  
ceppo di gré  
grey white matt  
marble green alpes  
green alpes black gold  
marble 490

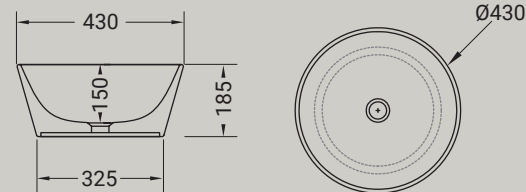

## WIRE 43X43 H65

struttura metallica per Wire  
Wire metal structure



Accessori disponibili non inclusi/  
Available accessories not included  
art.P82 - P50



### SIFONE

P82 - sifone CROMO per lavabo Euro 90,00  
P82N - sifone NERO per lavabo Euro 150,00  
P50 - sifone CROMO scarico terra Euro 300,00

P82 - CHROMED trap for washbasin Euro 90,00  
P82N - BLACK trap for washbasin Euro 150,00  
P50 - CHROMED trap for floor waste Euro 300,00

**ARTICOLO W3** — 8 kg | 8 pz pallet Italia | 14 pz pallet Export euro

**BIANCO LUCIDO**  **001**  
bianco lucido  
white 995

**COLORI DISPONIBILI**  **006**  **026**  **009**  
bianco matt  
white matt nero matt  
black matt nero lucido  
black shine 995

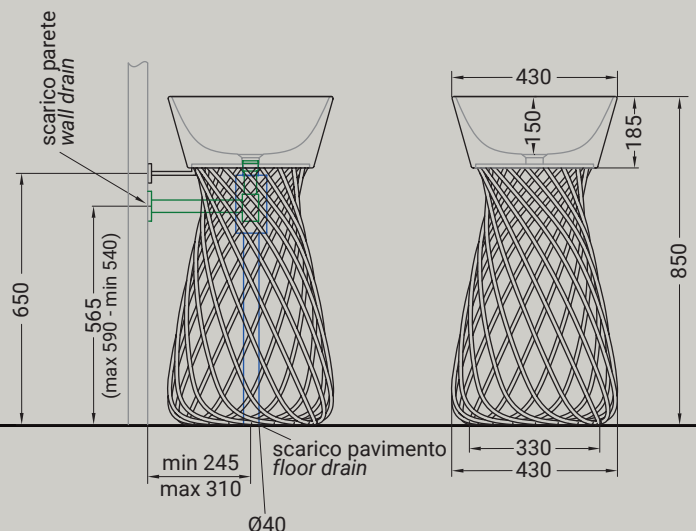







# HUB

MADE IN ITALY

**HUB, evoluzione naturale di una collezione di lavabi centro stanza creata con linee semplici ed eleganti che, si integrano perfettamente in ogni tipo di bagno, con uno stile unico e ricercato.**

---

*HUB, natural evolution of a collection of freestanding washbasins created with simple and elegant lines that integrate perfectly into any kind of bathroom, with a unique and refined style.*





## WIRE Ø43

lavabo appoggio  
countertop washbasin



Accessori disponibili non inclusi/  
Available accessories not included  
art.P85 - P90 - P125

### FISSAGGIO

P85 - sistema fissaggio per lavabi appoggio Euro 10,00  
P85 - fixing kit for countertop washbasin Euro 10,00

### PILETTA

P90 - piletta flusso continuo per lavabo Euro 72,00  
P125 - piletta click-clack o flusso continuo per lavabo con copertura in ceramica Euro 72,00

P90 - open outlet drain for washbasin Euro 72,00  
P125 - click-clack drain or open outlet drain for washbasin with ceramic cover Euro 72,00

ARTICOLO W1		— 9,3 kg   20 pz pallet Italia   34 pz pallet Export		euro	
BIANCO LUCIDO	001 bianco lucido white			240	
COLORI DISPONIBILI	006 bianco matt white matt	026 nero matt black matt	009 nero lucido black shine	097 rosa matt pink matt	360
DECORI DISPONIBILI	013 bianco/oro white/gold	014 bianco/platino white/platinum	063 bianco/oro rosa white/rose gold	650	
DECORO NERO/ORO	020 nero/oro black/gold			730	
TEXTURE DISPONIBILI	100 ceppo di gré grey	101 white matt marble	103 green alpes green alpes	104 black gold marble	490

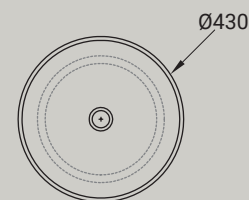
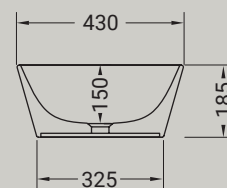

## HUB

struttura metallica per lavabo Wire  
metal structure suit for Wire washbasin

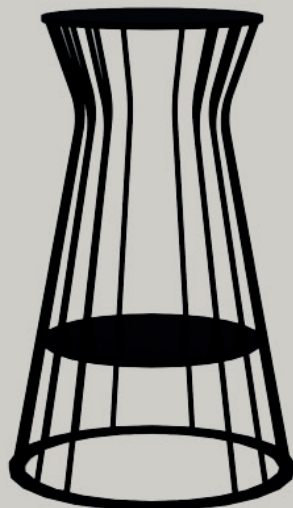

Accessori disponibili non inclusi/  
Available accessories not included  
art.P82

### SIFONE

P82 - sifone CROMO per lavabo Euro 90,00  
P82N - sifone NERO per lavabo Euro 150,00

P82 - CHROMED trap for washbasin Euro 90,00  
P82N - BLACK trap for washbasin Euro 150,00

ARTICOLO HU3		— 8 kg   8 pz pallet Italia   14 pz pallet Export		euro
COLORI DISPONIBILI	006 bianco matt white matt	026 nero matt black matt	115 corten corten	760

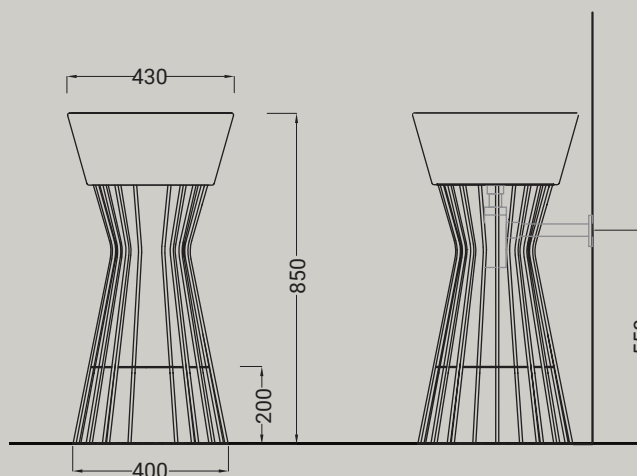







## HUB

struttura metallica con piano per lavabo  
 Wire, Sphere, Gio' rotondo  
*metal structure with round shelf suit for  
 Wire, Sphere, round washbasin Gio'*

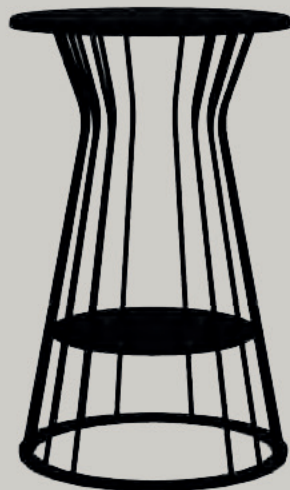





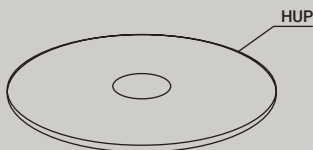

Accessori disponibili non inclusi/  
 Available accessories not included  
 art.P82

SIFONE  
 P82 - sifone CROMO per lavabo Euro 90,00  
 P82N - sifone NERO per lavabo Euro 150,00

P82 - CHROMED trap for washbasin Euro 90,00  
 P82N - BLACK trap for washbasin Euro 150,00



ARTICOLO HU3 + HUP		8 kg   8 pz pallet Italia   14 pz pallet Export			euro
HU3 struttura					760
	006 bianco matt white matt	026 nero matt black matt	115 corten corten		
	-----				
HUP piano per struttura					220
	006 bianco matt white matt	026 nero matt black matt	115 corten corten		
	-----				

### HU3 + HUP + SP22

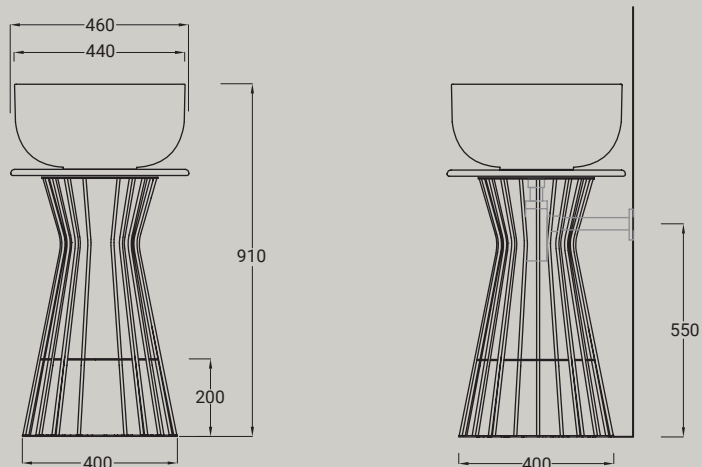

### HU3 + HUP + SP17

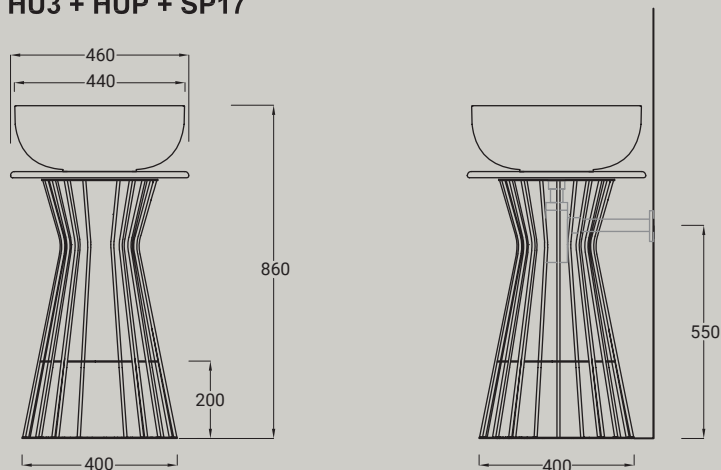

### HU3 + HUP + W1

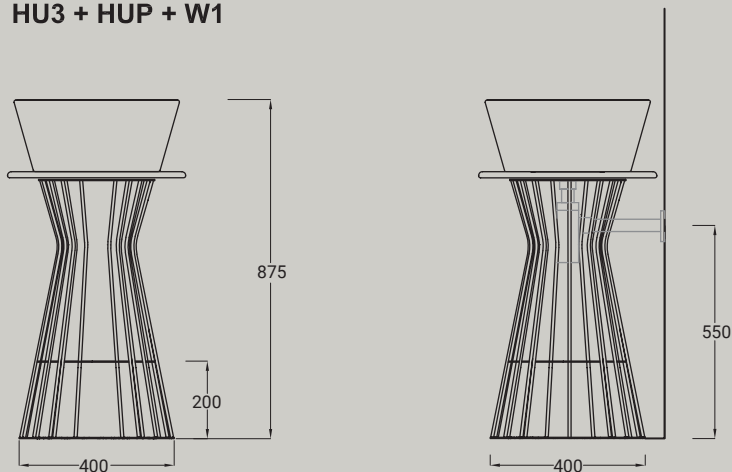

### HU3 + HUP + G42E

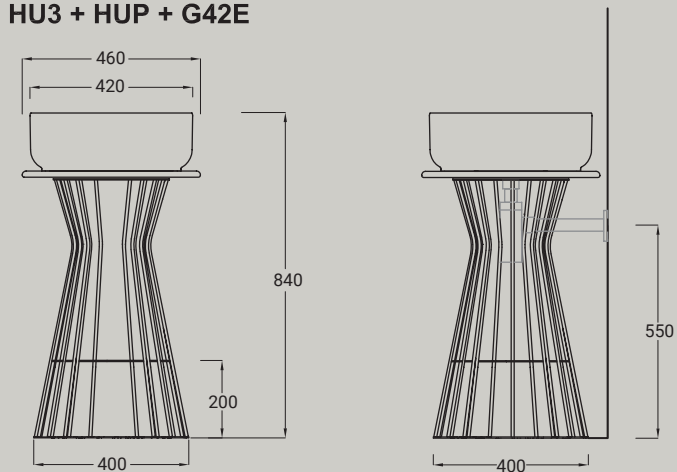







# SPHERE

MADE IN ITALY

**Una Collezione che si ispira all'utilizzo di una forma arrotondata che consente di arredare e impreziosire tutti gli ambienti bagno. La forma dei lavabi rappresenta la classica forma "a sfera", che interpreta il fascino discreto della modernità nella Collezione "Sphere"**

*A collection inspired by rounded shapes that furnish and embellish any bathroom. The design of the countertop washbasins represents the classical "sphere" shape, interpreting sensuality and seduction underline the design of all the items belonging into the "Sphere" collection*





HIDRA

SPHERE







HIDRA

SPHERE







006  
BIANCO MATT  
*white matt*



026  
NERO MATT  
*black matt*



053  
GRIGIO MATT  
*grey matt*



096  
MARRONE MATT  
*brown matt*



052  
VERDE MATT  
*green matt*



097  
ROSA MATT  
*pink matt*



001  
BIANCO LUCIDO



009  
SHINE BLACK



108  
SHINE GREY



105  
SHINE RED



106  
SHINE GREEN



109  
SHINE YELLOW



107  
SHINE BLU



116  
SHINE PINK





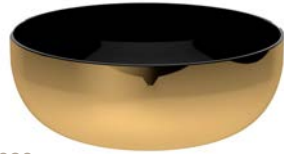

020  
NERO/ORO  
*black/gold*

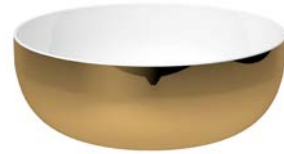

013  
BIANCO/ORO  
*white/gold*



014  
BIANCO/PLATINO  
*white/platinum*



063  
BIANCO/ORO ROSA  
*white/rose gold*



100  
CEPPO DI GRÈ  
*grey*



101  
white matt  
*marble*



103  
GREEN ALPES  
*marble*



104  
BLACK GOLD  
*marble*

## SPHERE

lavabo tondo da appoggio cm. 44X17h  
*round countertop washbasin cm. 44x17h*

Accessori disponibili non inclusi/  
*Available accessories not included*  
 art. P90 - P125

### PILETTA

P90 - piletta flusso continuo per lavabo Euro 72,00  
 P125 - piletta click-clack o flusso continuo per lavabo con copertura in ceramica Euro 72,00

P90 - open outlet drain for washbasin Euro 72,00  
 P125 - click-clack drain or open outlet drain for washbasin with ceramic cover Euro 72,00



ARTICOLO SP17		— 9,3 kg   20 pz pallet Italia   34 pz pallet Export						euro
BIANCO LUCIDO	001 bianco lucido <i>white</i>							280
COLORI DISPONIBILI	006 bianco matt <i>white matt</i>	026 nero matt <i>black matt</i>	053 grigio matt <i>grey matt</i>	052 verde matt <i>green matt</i>	096 marrone matt <i>brown matt</i>	097 rosa matt <i>pink matt</i>	420	
	009 shine nero <i>shine black</i>	106 shine green	108 shine grey	105 shine red	109 shine yellow	107 shine blu		116 shine pink
DECORI DISPONIBILI	013 bianco/oro <i>white/gold</i>	014 bianco/platino <i>white/platinum</i>	063 bianco/oro rosa <i>white/rose gold</i>	590		DECORO NERO/ORO	730	
						020 nero/oro <i>black/gold</i>		
TEXTURE DISPONIBILI	100 ceppo di gré <i>grey</i>	101 white matt <i>marble</i>	103 green alpes <i>green alpes</i>	104 black gold <i>marble</i>	520			

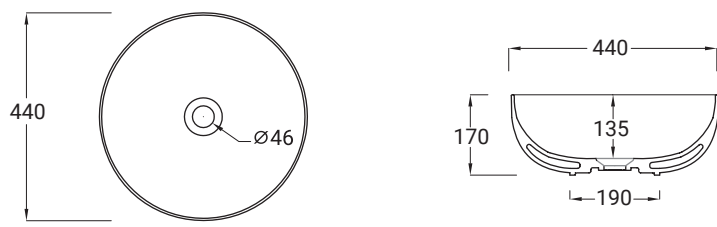

## SPHERE

lavabo tondo da appoggio cm. 44X22h  
*round countertop washbasin cm. 44x22h*

Accessori disponibili non inclusi/  
*Available accessories not included*  
 art. P90 - P125

### PILETTA

P90 - piletta flusso continuo per lavabo Euro 72,00  
 P125 - piletta click-clack o flusso continuo per lavabo con copertura in ceramica Euro 72,00

P90 - open outlet drain for washbasin Euro 72,00  
 P125 - click-clack drain or open outlet drain for washbasin with ceramic cover Euro 72,00



ARTICOLO SP22		— 9,3 kg   20 pz pallet Italia   34 pz pallet Export						euro
BIANCO LUCIDO	001 bianco lucido <i>white</i>							330
COLORI DISPONIBILI	006 bianco matt <i>white matt</i>	026 nero matt <i>black matt</i>	053 grigio matt <i>grey matt</i>	052 verde matt <i>green matt</i>	096 marrone matt <i>brown matt</i>	097 rosa matt <i>pink matt</i>	495	
	009 shine nero <i>shine black</i>	106 shine green	108 shine grey	105 shine red	109 shine yellow	107 shine blu		116 shine pink
DECORI DISPONIBILI	013 bianco/oro <i>white/gold</i>	014 bianco/platino <i>white/platinum</i>	063 bianco/oro rosa <i>white/rose gold</i>	650		DECORO NERO/ORO	815	
						020 nero/oro <i>black/gold</i>		
TEXTURE DISPONIBILI	100 ceppo di gré <i>grey</i>	101 white matt <i>marble</i>	103 green alpes <i>green alpes</i>	104 black gold <i>marble</i>	590			





**SPHERE**  
struttura 100

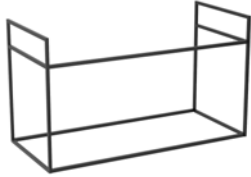

**ARTICOLO SPS100** euro  
**ARTICOLO SPS100-S\***

FINITURE DISPONIBILI **026** nero matt black matt 450

**SPHERE**  
piano 100  
shelf 100



**ARTICOLO KPS** euro

FINITURE DISPONIBILI **110** rovere rustico rustic oak **111** abete scuro spruce **112** cemento scuro concrete 200

**SPHERE**  
cassetto 96  
drawer 96



**ARTICOLO KC96** euro

FINITURE DISPONIBILI **110** rovere rustico rustic oak **111** abete scuro spruce **112** cemento scuro concrete 700



\*Struttura sospesa/Wall-hung structure







# DROP

MADE IN ITALY

**Drop è come una goccia d'acqua che scivola lungo la parete lasciando un'impronta nella ceramica. È un orinatoio molto stretto ed alto, concettualmente diverso dai soliti sistemi poiché occupa uno spazio limitato. Una fascia parallela al muro che scende e si piega nella parte del bacino. La vasca che si viene a creare è come una cucchiata scavata nel materiale. Le placche a muro permettono di creare una struttura stabile, senza comunque compromettere l'estetica del prodotto.**

*Drop as a water drop that slides down along the surface and leaves a footprint in the ceramic. A very tall and narrow urinal that takes up less room in the bathroom, very different from all the other urinals. The bowl is like a spoonful on the material. Size: 27 x 32x 90 cm.*





### DROP 27X32 H90

orinatoio + kit di fissaggio + sifone  
 urinal + fitting system kit + siphon



<b>ARTICOLO DR01</b> — 20 kg   16 pz pallet Italia   24 pz pallet Export		euro
<b>BIANCO LUCIDO</b>	 001 bianco lucido white	550
<b>COLORI DISPONIBILI</b>	 006 bianco matt white matt  026 nero matt black matt  009 nero lucido black shine	730

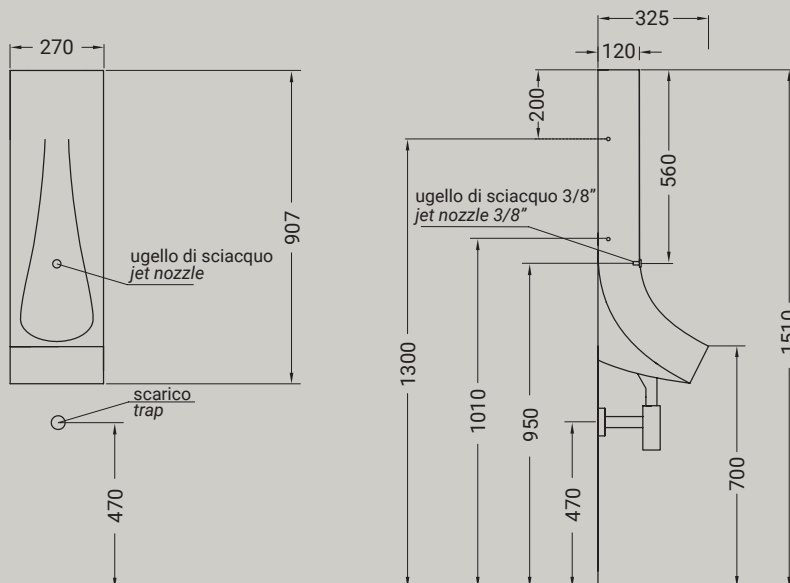

### DROP 27X32 H90

orinatoio con sensore di scarico  
 + kit di fissaggio+ sifone  
 urinal with flushing sensor  
 + fitting system kit + siphon



<b>ARTICOLO DR01F</b> — 20 kg   16 pz pallet Italia   24 pz pallet Export		euro
<b>BIANCO LUCIDO</b>	 001 bianco lucido white	790
<b>COLORI DISPONIBILI</b>	 006 bianco matt white matt  026 nero matt black matt  009 nero lucido black shine	970

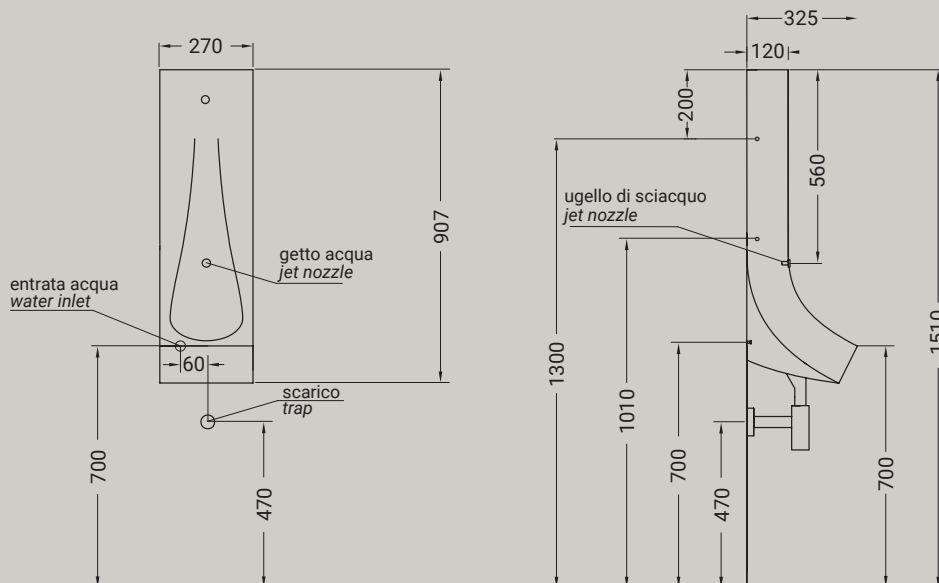

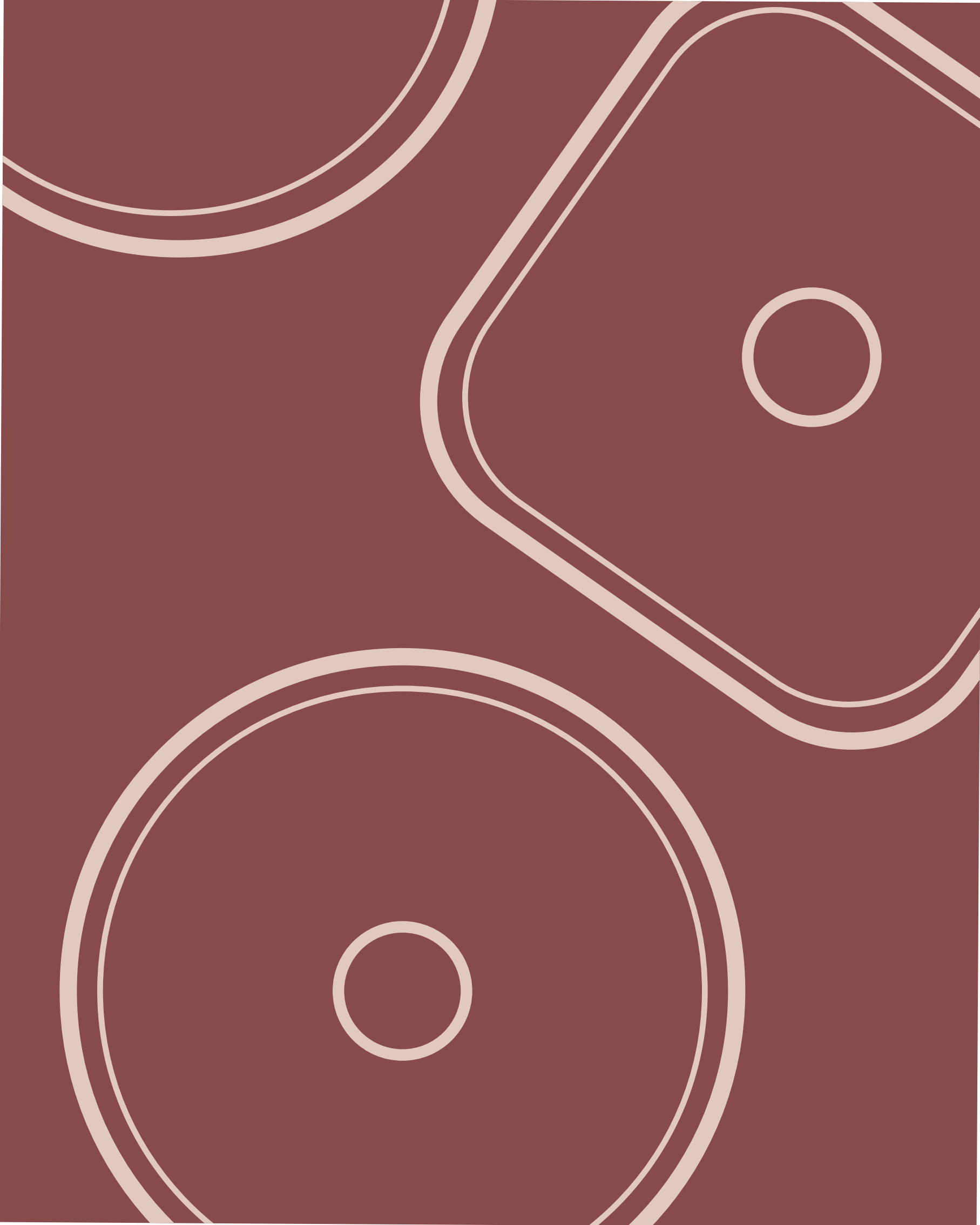





# COLLEZIONI

## COLLECTIONS

HI LINE  
ELLADE  
FASTER  
KIUB  
GIÒ EVOLUTION  
TOUR  
TOUR 4.0  
MY  
PIATTI DOCCIA  
LAVABI

**HI LINE**



# HI LINE

MADE IN ITALY

## WC

**HI10**

38x55 cm



**HIW10**

38x55 cm



**HI12**

38x68 cm



## BIDET

**HI14**

38x55 cm



**HIW14**

38x55 cm



## LAVABI

**HI17**

70x41 cm



**HI19**

65x51 cm







# HI LINE

**Hi Line: due livelli e due significati per capire il codice, l'insieme di segni che costruiscono le nuove forme. 'Hi', come fusione tra Hidra e High, è la sintesi dell'identità del brand aziendale con una collezione top ad alto contenuto di design: un binomio che sottolinea la capacità e la volontà dell'azienda di produrre oggetti sempre innovativi e design-oriented. Il secondo livello del codice viene espresso da 'line', inteso come studio formale sui tratti rappresentativi del progetto, veloci e dinamici ma anche morbidi e cremosi.**

*Hi Line is a code with two levels and two meanings. 'Hi' is the fusion between Hidra and High, the summary of the brand identity and a top class collection: a duo that highlights the willing to manufacture products always more design-oriented. 'Line' is the second level of the code that focuses on the more significant parts of the projects: fast lines, swift and smooth at the same time.*













HIDRA — HI LINE















## HI LINE DECORATI E TEXTURE



Hi Line è disponibile nei colori bianco e nero lucido. Si può scegliere anche la versione decorata: bianco/oro, nero/oro, bianco/platino, bianco/oro rosa, bianco/nero

*Hi Line is available in white and glossy black. You can also choose the decorated version: white / gold, black / gold, white / platinum, white / rose gold, white/black*

















009  
NERO LUCIDO  
*black shine*



012  
BIANCO/NERO  
*white/black*



013  
BIANCO/ORO  
*white/gold*



014  
BIANCO/PLATINO  
*white/platinum*



063  
BIANCO/ORO ROSA  
*white/rose gold*



020  
NERO/ORO  
*black/gold*



100  
CEPPO DI GRÈ  
*grey*



101  
white matt  
*marble*



103  
GREEN ALPES  
*marble*



104  
BLACK GOLD  
*marble*

**HI LINE**

vaso sospeso + kit fissaggio  
WC wall-hung + fixing kit



ARTICOLO HIW10 — 24,3 kg   12 pz pallet Italia   20 pz pallet Export		euro			
BIANCO LUCIDO	001 bianco lucido white	450			
COLORI DISPONIBILI	009 nero lucido black shine	012 bianco/nero white/black	675		
DECORI DISPONIBILI	013 bianco/oro white/gold	014 bianco/platino white/platinum	063 bianco/oro rosa white/rose gold	795	
DECORO NERO/ORO	020 nero/oro black/gold	995			
TEXTURE DISPONIBILI	100 ceppo di gré grey	101 white matt marble	103 green alpes green alpes	104 black gold marble	675

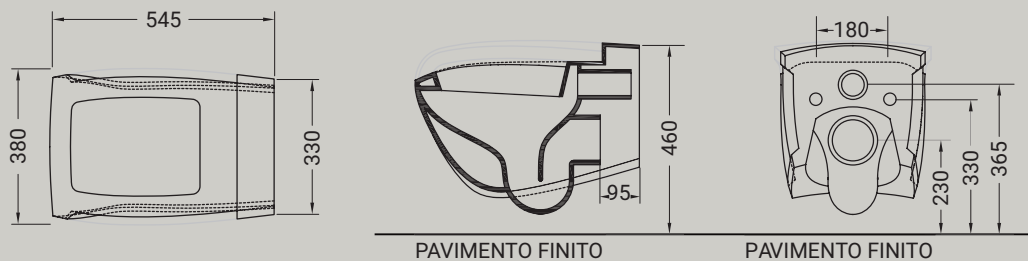

**HI LINE**

bidet sospeso + kit fissaggio  
bidet wall-hung + fixing kit



Accessori disponibili non inclusi/  
Available accessories not included  
art.P91

SIFONE  
P91 - sifone ribassato per bidet Euro 80,00  
P91 - CHROMED trap for washbasin Euro 80,00

ARTICOLO HIW14 — 19,5 kg   12 pz pallet Italia   20 pz pallet Export		euro			
BIANCO LUCIDO	001 bianco lucido white	450			
COLORI DISPONIBILI	009 nero lucido black shine	012 bianco/nero white/black	675		
DECORI DISPONIBILI	013 bianco/oro white/gold	014 bianco/platino white/platinum	063 bianco/oro rosa white/rose gold	770	
DECORO NERO/ORO	020 nero/oro black/gold	990			
TEXTURE DISPONIBILI	100 ceppo di gré grey	101 white matt marble	103 green alpes green alpes	104 black gold marble	675

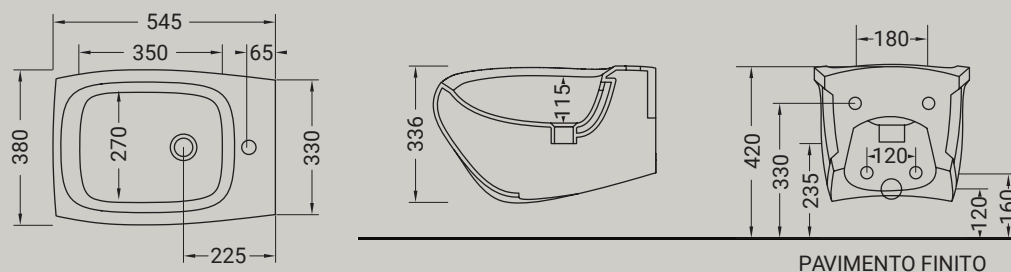



## HI LINE

vaso terra filomuro + kit di fissaggio  
wc back to wall + fixing kit



Accessori disponibili non inclusi/  
Available accessories not included  
art.P57 - P81

**CURVA**  
P57 - curva scarico pavimento Euro 25,00  
P57 - vertical outlet plastic pipe Euro 25,00

**RACCORDO**  
P81 - raccordo di scarico parete Euro 25,00  
P81 - horizontal outlet plastic pipe Euro 25,00

ARTICOLO HI10 — 26 kg   10 pz pallet Italia   20 pz pallet Export		euro
BIANCO LUCIDO	001 bianco lucido white	450
COLORI DISPONIBILI	009 nero lucido black shine                      012 bianco/nero white/black	675
DECORI DISPONIBILI	013 bianco/oro white/gold                      014 bianco/platino white/platinum                      063 bianco/oro rosa white/rose gold	795
DECORO NERO/ORO	020 nero/oro black/gold	995
TEXTURE DISPONIBILI	100 ceppo di gré grey                      101 white matt marble                      103 green alpes green alpes                      104 black gold marble	675

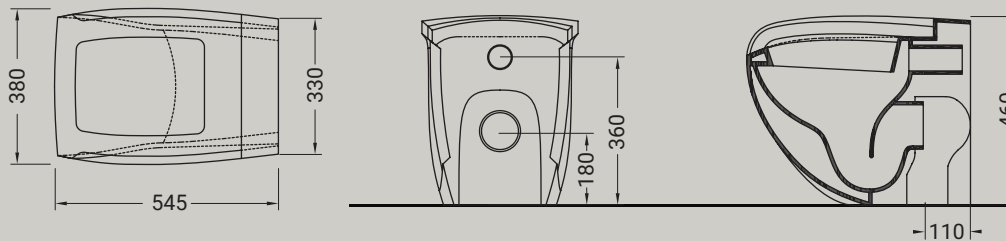

## HI LINE

bidet terra filomuro 1 foro  
+ kit di fissaggio  
bidet back to wall 1 hole + fixing kit



ARTICOLO HI14 — 21,5 kg   10 pz pallet Italia   20 pz pallet Export		euro
BIANCO LUCIDO	001 bianco lucido white	450
COLORI DISPONIBILI	009 nero lucido black shine                      012 bianco/nero white/black	675
DECORI DISPONIBILI	013 bianco/oro white/gold                      014 bianco/platino white/platinum                      063 bianco/oro rosa white/rose gold	795
DECORO NERO/ORO	020 nero/oro black/gold	995
TEXTURE DISPONIBILI	100 ceppo di gré grey                      101 white matt marble                      103 green alpes green alpes                      104 black gold marble	675

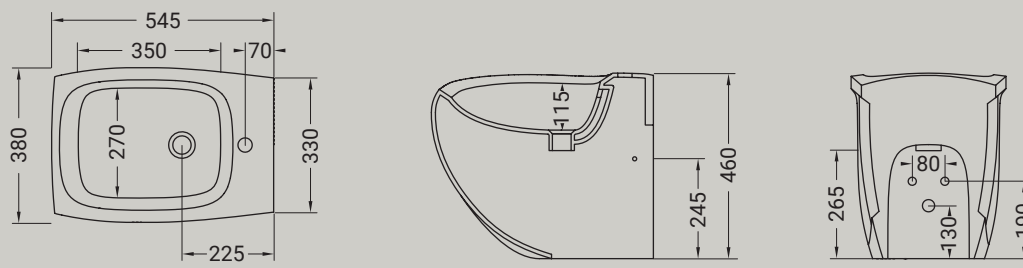

**HI LINE**

vaso monoblocco + kit di fissaggio  
wc close-coupled + fixing kit



Accessori disponibili non inclusi/  
Available accessories not included  
art.P57 - P81

**CURVA**  
P57 - curva scarico pavimento Euro 25,00  
P57 - vertical outlet plastic pipe Euro 25,00

**RACCORDO**  
P81 - raccordo di scarico parete Euro 25,00  
P81 - horizontal outlet plastic pipe Euro 25,00

ARTICOLO HI12		— 34,8 kg   6 pz pallet Italia   9 pz pallet Export	euro		
BIANCO LUCIDO	001 bianco lucido/white		530		
COLORI DISPONIBILI	009 nero lucido/black shine	012 bianco/nero/white/black	800		
DECORI DISPONIBILI	013 bianco/oro/white/gold	014 bianco/platino/white/platinum	063 bianco/oro rosa/white/rose gold	1060	
DECORO NERO/ORO	020 nero/oro/black/gold		1330		
TEXTURE DISPONIBILI	100 ceppo di gré/grey	101 white matt/marble	103 green alpes/green alpes	104 black gold/marble	800

CASSETTA MB PER HI12		— 13,8 kg	euro
meccanismo P10 non incluso / flushing system P10 not included			euro

ARTICOLO DL18	001 bianco lucido/white	180	009 nero lucido/black shine	270
---------------	----------------------------	-----	--------------------------------	-----

CISTERNA IN PVC CON DISPOSITIVO DI SCARICO DOPPIO FLUSSO GEBERIT		— 1,5 kg	euro
GEBERIT PLASTIC CISTERN WITH WAST SYSTEM DOUBLE FLOW CHROME			

ARTICOLO P10	cromo/chrome	180		
ARTICOLO P100	oro/gold	ARTICOLO P10B	bronzo/bronze	210

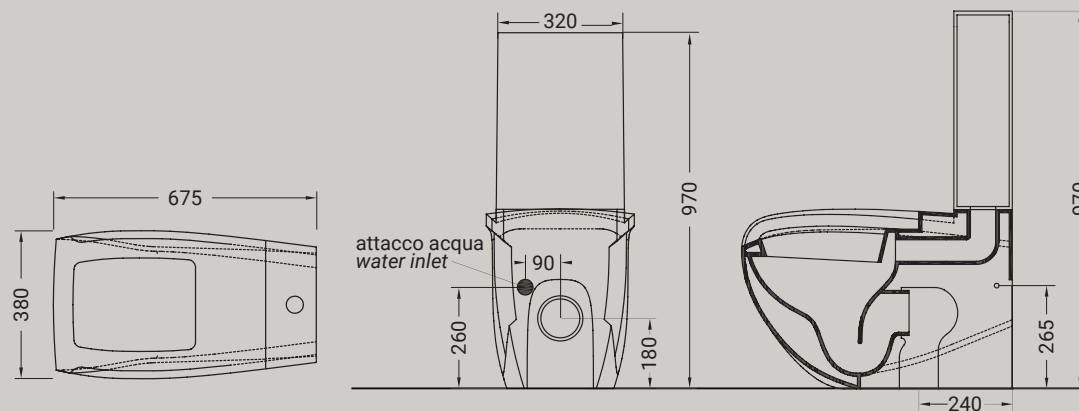

**HI LINE**

seduta per WC frizionata,  
cerniera CROMO  
seat cover soft closing  
system + hinges  
CHROME



**HI LINE**

seduta per WC frizionata,  
cerniera ORO  
seat cover soft closing  
system + hinges  
GOLD



ARTICOLO HIZ		— 3 kg	euro	ARTICOLO HIZO		— 3 kg	euro
BIANCO LUCIDO	001 bianco lucido/white	160	COLORI DISPONIBILI	009 nero lucido/black shine	235		
BIANCO LUCIDO	001 bianco lucido/white	240	COLORI DISPONIBILI	009 nero lucido/black shine	300		



**HI LINE**

lavabo appoggio  
countertop washbasin

Accessori disponibili non inclusi/  
Available accessories not included  
art. P125



**PILETTA**  
P125 - piletta click-clack o flusso continuo per  
lavabo con copertura in ceramica Euro 72,00  
P125 - click-clack drain or open outlet drain for  
washbasin with ceramic cover Euro 72,00

ARTICOLO HI17 — 16,8 kg   12 pz pallet Italia   26 pz pallet Export		euro
BIANCO LUCIDO	001 bianco lucido white	300
COLORI DISPONIBILI	009 nero lucido black shine	450
	012 bianco/nero white/black	
DECORI DISPONIBILI	013 bianco/oro white/gold	560
	014 bianco/platino white/platinum	
	063 bianco/oro rosa white/rose gold	
DECORO NERO/ORO	020 nero/oro black/gold	710

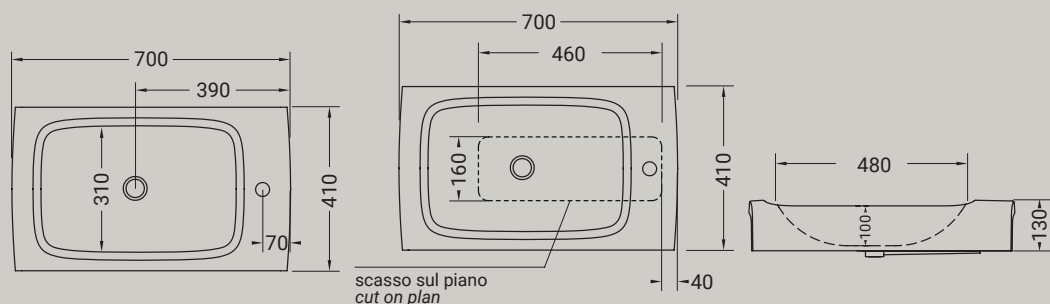

**HI LINE**

lavabo 1 foro sospeso  
wall-hung washbasin 1 hole



Accessori disponibili non inclusi/  
Available accessories not included  
art. P22 - P82 - P125

**FISSAGGIO**  
P22 - sistema di fissaggio per lavabi sospesi  
per muro portante Euro 10,00  
P22 - fixing kit for wall-hung washbasin for  
load-bearing wall Euro 10,00

**SIFONE**  
P82 - sifone CROMO per lavabo Euro 90,00  
P82 - CHROMED trap for washbasin Euro 90,00

**PILETTA**  
P125 - piletta click-clack o flusso continuo per  
lavabo con copertura in ceramica Euro 72,00  
P125 - click-clack drain or open outlet drain for  
washbasin with ceramic cover Euro 72,00

ARTICOLO HI19 — 23,2 kg   10 pz pallet Italia   20 pz pallet Export		euro
BIANCO LUCIDO	001 bianco lucido white	300
COLORI DISPONIBILI	009 nero lucido black shine	450
	012 bianco/nero white/black	
DECORI DISPONIBILI	013 bianco/oro white/gold	560
	014 bianco/platino white/platinum	
	063 bianco/oro rosa white/rose gold	
DECORO NERO/ORO	020 nero/oro black/gold	710

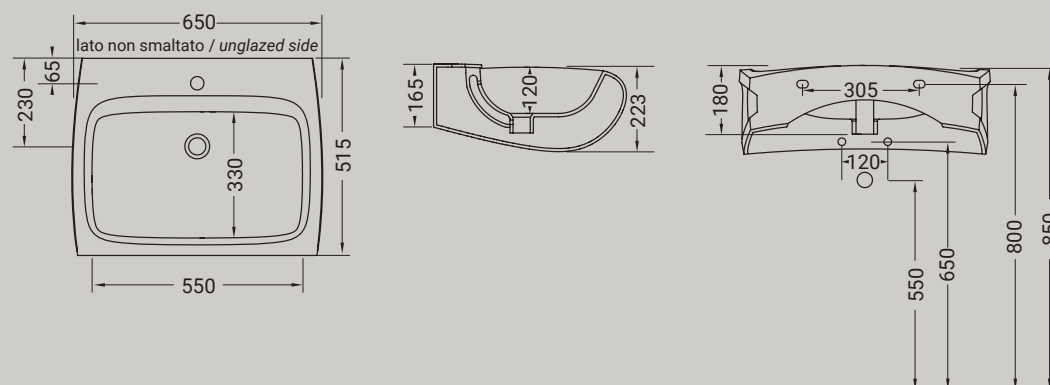

**ELLADE**



# ELLADE

## WC

**D10R**

36X55 cm



**D11R**

36X55 cm



**D12R**

36X71 cm



**D13R**

36X71 cm



**D20**

36X55 cm



**D23**

36X71 cm



**DW10**

36X55 cm



## BIDET

**D14**

36X55 cm



**D24**

36X55 cm



**DW14**

36X55 cm



## LAVABI

**D15**

68X55 cm



**D30**

112X63 cm



**D31**

93X58 cm







design Hidra Ceramica



# ELLADE

MADE IN ITALY

**Linee morbide che raccontano la storia di un luogo caldo ed accogliente, profumato e seducente; oggetti che evocano atmosfere ottocentesche sono i perfetti protagonisti di ambienti classici, e, nello stesso tempo, sono perfettamente inseribili in morbidi contesti contemporanei. Citazioni stilistiche per una serie completa di consolle e lavabi, monoblocco e sanitari raffinati, arricchiti da dettagli pregiati, da accessori coordinati, da complementi d'autore.**

*Soft lines tell the story. A story of a warm and welcoming, fragrant and seductive room. A room filled with items that evoke nineteenth century atmospheres and are the ideal protagonists for classic settings, while at the same time, fit perfectly with soft, contemporary looks. Citations in style for a complete series of elegant consoles, washbasins, tank toilets, bowls and bidets, enhanced with fine details, coordinated and designer accessories.*











HIDRA — ELLADE































## ELLADE DECORATI



Ellade è disponibile nei colori bianco e nero lucido. Si può scegliere anche la versione decorata: bianco/oro, nero/oro  
*Ellade is available in white and glossy black. You can also choose the decorated version: white / gold, black / gold*





009  
NERO LUCIDO  
*black shine*



013  
BIANCO/ORO  
*white/gold*







020  
NERO/ORO  
*black/gold*

## ELLADE

wc sospeso + kit fissaggio  
wc wall-hug + fixing kit



ARTICOLO DW10 — 17,7 kg   15 pz pallet Italia   20 pz pallet Export		euro
BIANCO LUCIDO	 001 bianco lucido white	315
COLORI DISPONIBILI	 009 nero lucido black shine	450
DECORI DISPONIBILI	 013 bianco/oro white/gold	695
DECORO NERO/ORO	 020 nero/oro black/gold	825

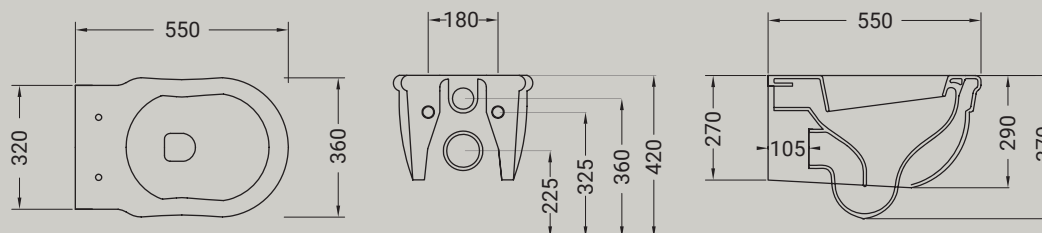

## ELLADE

bidet sospeso + kit fissaggio  
bidet wal-hung + fixing kit



ARTICOLO DW14 — 44 kg   15 pz pallet Italia   20 pz pallet Export		euro
BIANCO LUCIDO	 001 bianco lucido white	315
COLORI DISPONIBILI	 009 nero lucido black shine	450
DECORI DISPONIBILI	 013 bianco/oro white/gold	695
DECORO NERO/ORO	 020 nero/oro black/gold	825

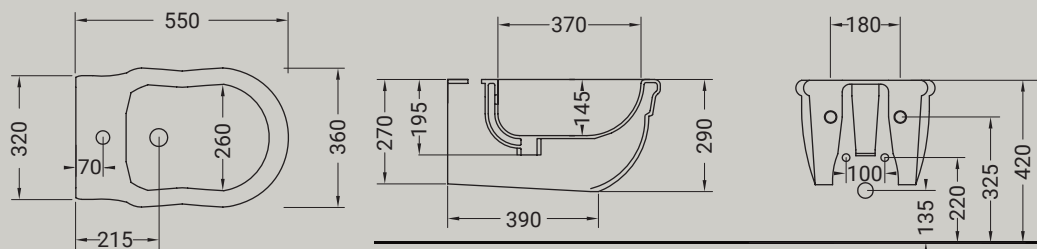

Accessori disponibili non inclusi/  
Available accessories not included  
art.P91

SIFONE  
P91 - sifone ribassato per bidet Euro 80,00  
P91 - CHROMED trap for washbasin Euro 80,00



**ELLADE**

wc senza brida scarico pavimento + kit fissaggio  
 wc rimless with floor draining + fixing kit



ARTICOLO D10R — 17,3 kg   15 pz pallet Italia   20 pz pallet Export		euro
BIANCO LUCIDO	001 bianco lucido white	315
COLORI DISPONIBILI	009 nero lucido black shine	450
DECORI DISPONIBILI	013 bianco/oro white/gold	695
DECORO NERO/ORO	020 nero/oro black/gold	825

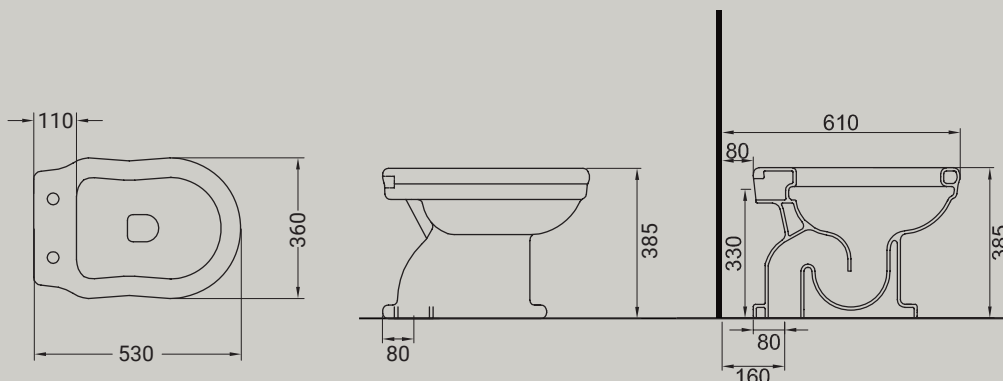

**ELLADE**

wc senza brida scarico parete + kit fissaggio  
 wc rimless with wall draining



ARTICOLO D11R — 19,2 kg   15 pz pallet Italia   20 pz pallet Export		euro
BIANCO LUCIDO	001 bianco lucido white	315
COLORI DISPONIBILI	009 nero lucido black shine	450
DECORI DISPONIBILI	013 bianco/oro white/gold	695
DECORO NERO/ORO	020 nero/oro black/gold	825

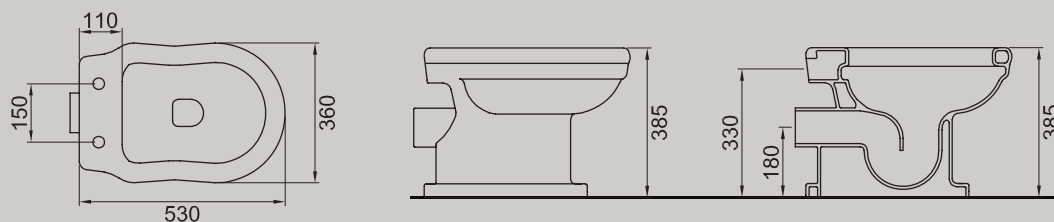

## ELLADE

bidet monoforo predisposto 3/fori + kit fissaggio  
bidet 1th (3 th) + fixing kit



ARTICOLO D14 — 16,9 kg   15 pz pallet Italia   20 pz pallet Export		euro
BIANCO LUCIDO	001 bianco lucido white	315
COLORI DISPONIBILI	009 nero lucido black shine	450
DECORI DISPONIBILI	013 bianco/oro white/gold	695
DECORO NERO/ORO	020 nero/oro black/gold	825

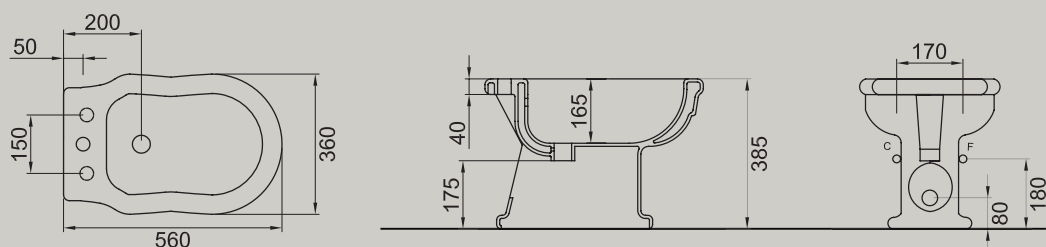

## ELLADE

vaso filomuro traslato + kit fissaggio  
wc back to wall adjustable flush + fixing kit



ARTICOLO D20 — 24 kg   10 pz pallet Italia   20 pz pallet Export		euro
BIANCO LUCIDO	001 bianco lucido white	315
COLORI DISPONIBILI	009 nero lucido black shine	450
DECORI DISPONIBILI	013 bianco/oro white/gold	695
DECORO NERO/ORO	020 nero/oro black/gold	835

Accessori disponibili non inclusi/  
Available accessories not included  
art.P57 - P59 - P60 - P81

A\*

### CURVE SCARICO PAVIMENTO

curva P59 - scarico regolabile da 60 a 90 Euro 30,00  
curva P57 - scarico regolabile da 100 a 120 Euro 25,00  
curva P60 - scarico regolabile da 160 a 170 Euro 30,00

### VERTICAL OUTLET PLASTIC PIPE

vertical outlet P59 - adjustable 60-90 Euro 30,00  
vertical outlet P57 - adjustable 100-120 Euro 25,00  
vertical outlet P60 - adjustable 160-170 Euro 30,00

### RACCORDO

P81 - raccordo di scarico parete Euro 25,00  
P81 - horizontal outlet plastic pipe Euro 25,00

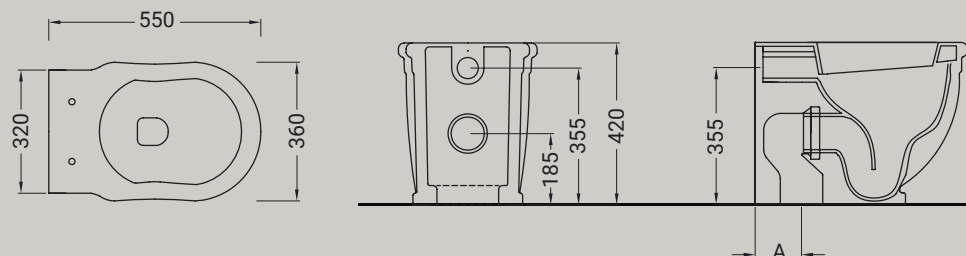



**ELLADE**

bidet filomuro monoforo + kit fissaggio  
bidet back to wall 1th + fixing kit

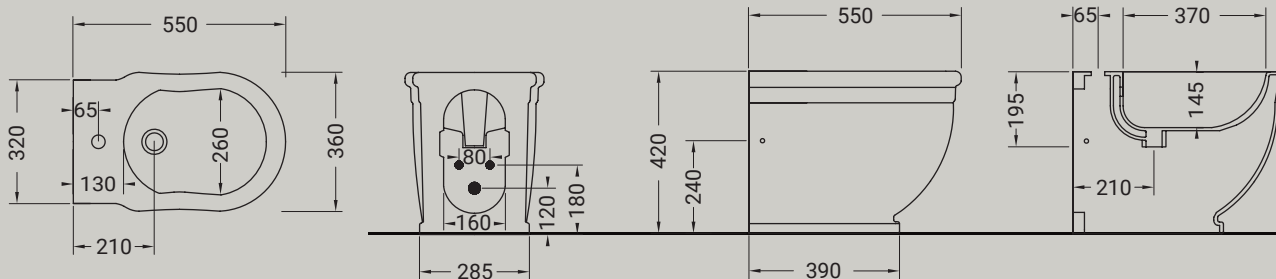

ARTICOLO D24 — 24 kg   10 pz pallet Italia   20 pz pallet Export		euro
BIANCO LUCIDO	001 bianco lucido white	315
COLORI DISPONIBILI	009 nero lucido black shine	450
DECORI DISPONIBILI	013 bianco/oro white/gold	695
DECORO NERO/ORO	020 nero/oro black/gold	835

**ELLADE**

wc monoblocco rimless scarico pavimento  
+ kit fissaggio  
wc close-coupled rimless with floor draining  
+ fixing kit

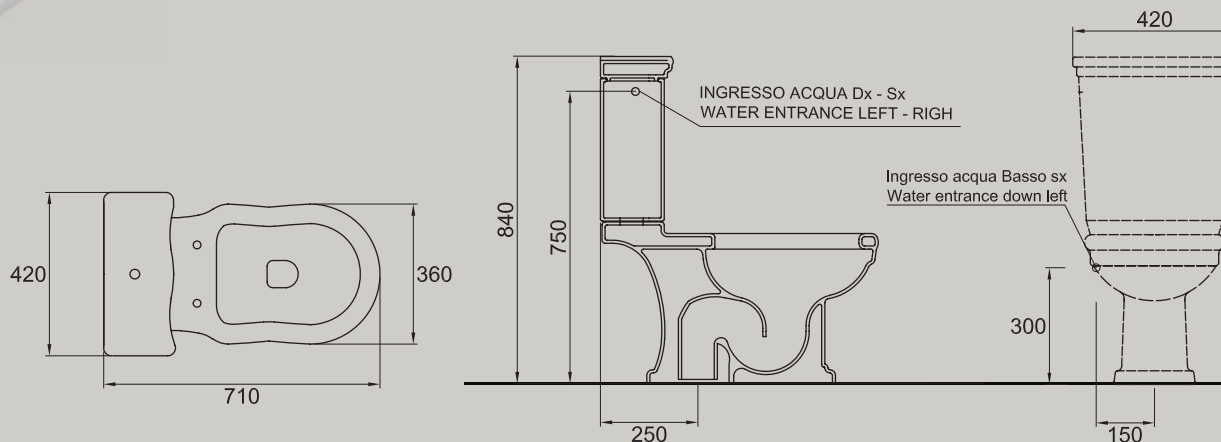

ARTICOLO D12R — 20,8 kg   8 pz pallet Italia   12 pz pallet Export		euro
BIANCO LUCIDO	001 bianco lucido white	350
COLORI DISPONIBILI	009 nero lucido black shine	500
DECORI DISPONIBILI	013 bianco/oro white/gold	725
DECORO NERO/ORO	020 nero/oro black/gold	855

**ELLADE**

wc monoblocco rimless scarico parete  
+ kit fissaggio  
*wc close-coupled rimless with wall draining  
+ fixing kit*

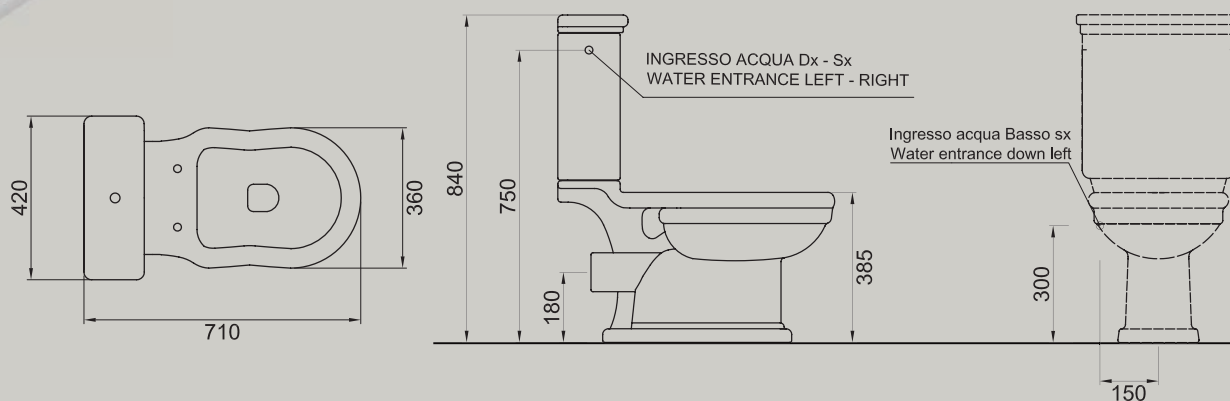

ARTICOLO D13R — 21,3 kg   8 pz pallet Italia   12 pz pallet Export		euro
BIANCO LUCIDO	001 bianco lucido white	350
COLORI DISPONIBILI	009 nero lucido black shine	500
DECORI DISPONIBILI	013 bianco/oro white/gold	725
DECORO NERO/ORO	020 nero/oro black/gold	855

**ELLADE**

cassetta monoblocco per D12/D13  
*ceramic cistern for D12/D13*



ARTICOLO D18 — 21,3 kg		euro
BIANCO LUCIDO	001 bianco lucido white	180
COLORI DISPONIBILI	009 nero lucido black shine	250
<b>MECCANISMO DI SCARICO DOPPIO FLUSSO BASSO/ALTO</b> <i>DUAL FLUSHING SYSTEM LOW AND HIGH WATER INLET</i>		— 0,8 kg
ARTICOLO P7778	000 cromo/chrome	90
ARTICOLO P77780	001 oro/gold	110
ARTICOLO P7778BR	002 bronzo/bronze	



**ELLADE**

wc monoblocco filomuro traslato + kit fissaggio  
 wc close coupled back to wall adjustable flush  
 + fixing kit



Accessori disponibili non inclusi/  
 Available accessories not included  
 art.P57 - P59 - P60 - P81

**A\***

**CURVE SCARICO PAVIMENTO**

curva P59 - scarico regolabile da 150 a 245 Euro 30,00  
 curva P57 - scarico regolabile - 295 Euro 25,00  
 curva P60 - scarico regolabile da 245 a 335 Euro 30,00

**VERTICAL OUTLET PLASTIC PIPE**

vertical outlet P59 - adjustable 150-245 Euro 30,00  
 vertical outlet P57 - adjustable -295 Euro 25,00  
 vertical outlet P60 - adjustable 245-335 Euro 30,00

**RACCORDO**

P81 - raccordo di scarico a parete Euro 25,00  
 P81 - horizontal outlet plastic pipe Euro 25,00

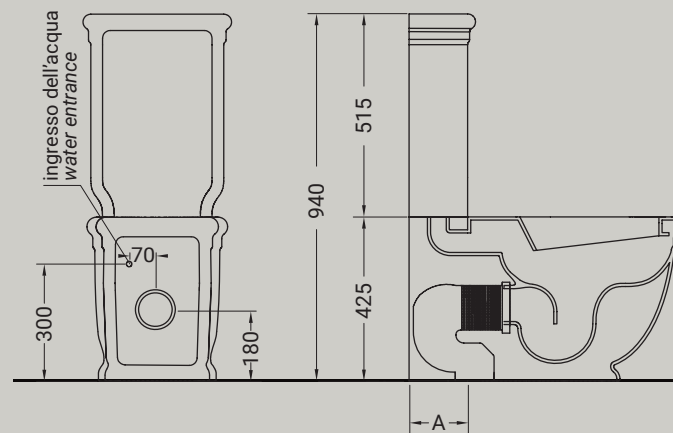
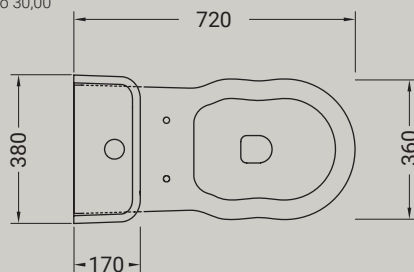

ARTICOLO D23 — 34 kg   6 pz pallet Italia   9 pz pallet Export		euro
BIANCO LUCIDO	001 bianco lucido white	410
COLORI DISPONIBILI	009 nero lucido black shine	590
DECORI DISPONIBILI	013 bianco/oro white/gold	815
DECORO NERO/ORO	020 nero/oro black/gold	935

**ELLADE**

cassetta mb per D23  
 cistern mb for D23



ARTICOLO D28 — 12,4 kg		euro
BIANCO LUCIDO	001 bianco lucido white	180
COLORI DISPONIBILI	009 nero lucido black shine	250
<b>CISTERNA IN PVC CON DISPOSITIVO DI SCARICO DOPPIO FLUSSO GEBERIT</b> GEBERIT PLASTIC CISTERN WITH WAST SYSTEM DOUBLE FLOW CHROME — 1,5 kg euro		
ARTICOLO P10	010 cromo/chrome	180
ARTICOLO P100	010A oro/gold	210
ARTICOLO P10B	010B bronz/bronze	

**ELLADE**

cassetta alta con coperchio  
high ceramic cistern with lid

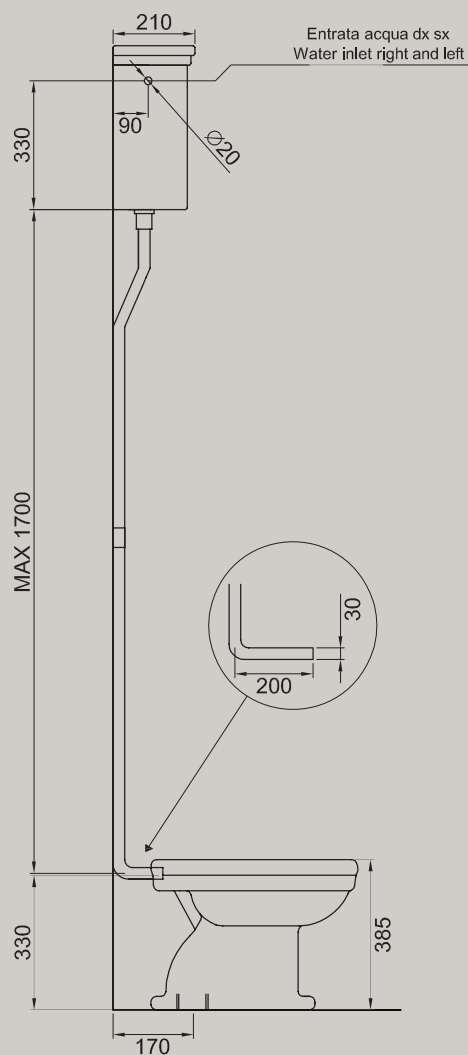

<b>ARTICOLO D59</b> — 11,9 kg		euro			
BIANCO LUCIDO	001 bianco lucido white	180			
COLORI DISPONIBILI	009 nero lucido black shine	250			
<b>TUBO DI SCARICO / CHROME DRAIN PIPE</b> — 2,1 kg		euro			
<b>ARTICOLO D102</b>	cromo/chrome	190			
<b>ARTICOLO D103</b>	oro/gold	330	<b>ARTICOLO D105</b>	bronzo/bronze	270
<b>BATTERIA SCARICO / FLUSHING MECHANISM</b> — 3,0 kg		euro			
<b>ARTICOLO D100</b>	cromo chrome	250			
<b>ARTICOLO D100N</b>	nero/cromo black/chrome	260			
<b>ARTICOLO D101</b>	oro gold	420	<b>ARTICOLO D104</b>	bronzo bronze	350
<b>ARTICOLO D101N</b>	nero/oro black/gold	435	<b>ARTICOLO D104N</b>	nero/bronzo black/bronze	360

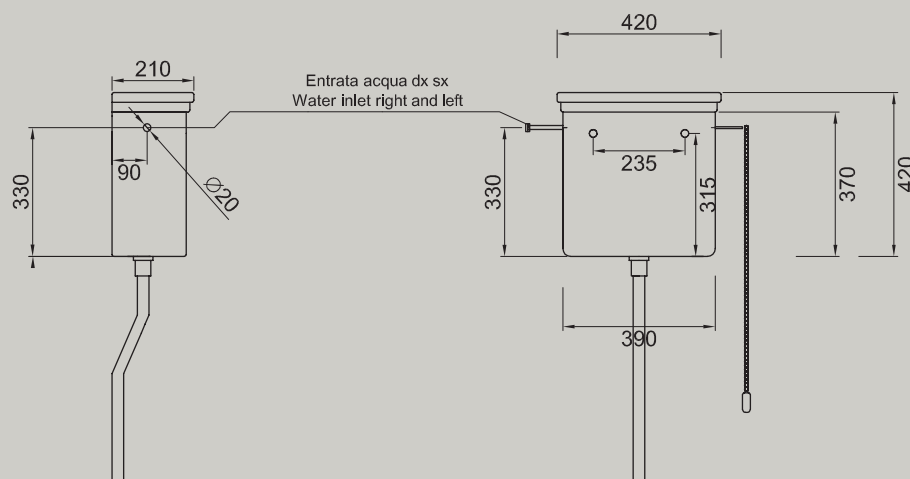

**FOCUS ON**  
cassetta alta con coperchio  
high ceramic cistern with lid



**ELLADE**

cassetta a zaino  
low level cistern with lid





**ARTICOLO D58** – 8,5 kg euro

**BIANCO LUCIDO**  **001**  
bianco lucido  
white 180

**COLORI DISPONIBILI**  **009**  
nero lucido  
black shine 250

**MECCANISMO SCARICO CON MANIGLIA FRONTALE E TUBO ESTERNO DI SCARICO** – 1,5 kg euro  
FLUSHING SYSTEM WITH FRONT HANDLE AND EXTERNAL WASTE TUBE

**ARTICOLO P18**  215  
cromo/chrome

**ARTICOLO P19**  **310** **ARTICOLO P20**  **310**  
oro/gold bronzo/bronze

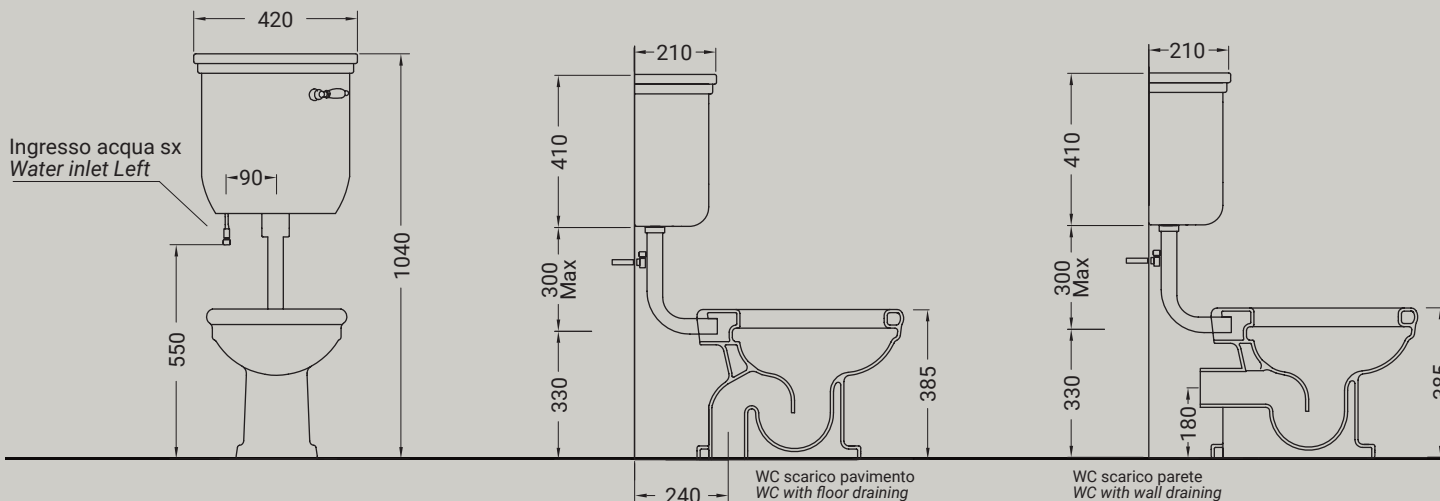

**ELLADE**

copri wc poliestere  
cerniera CROMO  
white seat cover  
with CHROME  
hinges



copri wc rallenty con cerniera CROMO  
seat cover with CHROME  
hinges with soft closing system

copri wc rallenty con cerniera BRONZO  
seat cover with BRONZE hinges with  
soft closing system

**ARTICOLO DX** – 15,0 kg euro

**BIANCO LUCIDO**  **001**  
bianco lucido  
white 105

**COPRI WC RALLENTY CON CERNIERA CROMO** – 3,5 kg euro

**ARTICOLO DXZ**  **001**  
bianco lucido  
white 170

**ARTICOLO DXNZ**  230  
nero lucido  
black shine

**COPRI WC RALLENTY CON CERNIERA BRONZO** – 3,5 kg euro

**ARTICOLO DZA**  **001**  
bianco lucido  
white 230

**ARTICOLO DXNZB**  260  
nero lucido  
black shine

**ELLADE**

copri wc rallenty con cerniera ORO  
 seat cover with GOLD hinges  
 with soft closing system



**COPRI WC RALLENTY CON CERNIERA – 3,5 kg** euro



<b>ARTICOLO DZB</b>	 <b>001</b> bianco lucido <i>white</i>	230
<b>ARTICOLO DXNZO</b>	 <b>nero lucido</b> <i>black shine</i>	260

**ELLADE**

seduta per WC in noce massello  
 frizionata, cerniera CROMO, BRONZO, ORO  
 soft-close walnut wood WC seat,  
 CHROME, BRONZE, GOLD hinge



**SEDUTA WC IN NOCE MASSELLO – 3,5 kg** euro





<b>ARTICOLO DZN</b>	 <b>cromo/chrome</b>	230
<b>ARTICOLO DZE</b>	 <b>bronzo/bronze</b>	260
<b>ARTICOLO DZF</b>	 <b>oro/gold</b>	260

**ELLADE**

lavabo su colonna 68 monoforo predisposto 3 fori  
 washbain cm.68 1th (3th)



**ARTICOLO D15 – 23 kg | 12 pz pallet Italia | 16 pz pallet Export** euro

<b>BIANCO LUCIDO</b>	 <b>001</b> bianco lucido <i>white</i>	290
<b>COLORI DISPONIBILI</b>	 <b>009</b> nero lucido <i>black shine</i>	435
<b>DECORI DISPONIBILI</b>	 <b>013</b> bianco/oro <i>white/gold</i>	505
<b>DECORO NERO/ORO</b>	 <b>020</b> nero/oro <i>black/gold</i>	630

Accessori disponibili non inclusi/  
 Available accessories not included  
 art.P22 - P82 - P125

**FISSAGGIO**  
 P22 - sistema di fissaggio per lavabi sospesi per muro portante Euro 10,00  
 P22 - fi xing kit for wal-hung washbasin for load-bearing wall Euro 10,00

**PILETTA**  
 P125 - piletta click-clack o flusso continuo per lavabo con copertura in ceramica Euro 72,00  
 P125 - click-clack drain or open outlet drain for washbasin with ceramic cover Euro 72,00

**SIFONE**  
 P82 - sifone CROMO per lavabo Euro 90,00  
 P82 - CHROMED trap for washbasin Euro 90,00

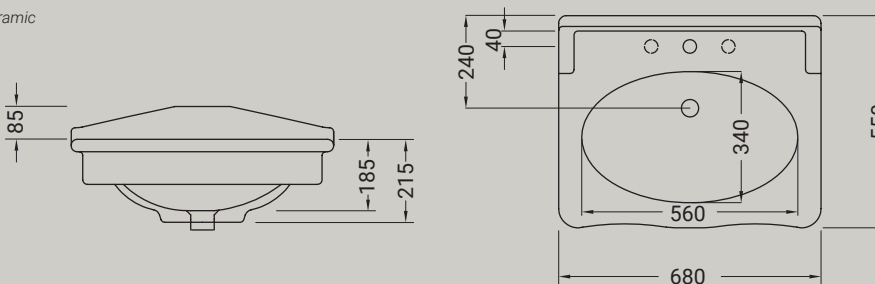



## ELLADE

colonna  
pedestal for washbasin D15



ARTICOLO D16 — 11,1 kg   14 pz pallet Italia   27 pz pallet Export		euro
BIANCO LUCIDO	 001 bianco lucido white	180
COLORI DISPONIBILI	 009 nero lucido black shine	265
DECORO BIANCO/ORO	 020 bianco/oro white/gold	335

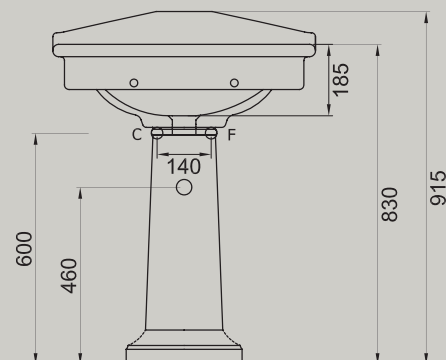

## ELLADE

consolle cm 93 monoforo predisposto 3 fori  
consolle cm 93 1th (3 th)



Accessori disponibili non inclusi/  
Available accessories not included  
art.P22 - P82 - P125

**FISSAGGIO**  
P22 - sistema fissaggio per lavabi sospesi per muro portante Euro 10,00  
P22 - fixing kit for wall-hung washbasin for load-bearing wall Euro 10,00

**PILETTA**  
P125 - piletta click-clack o flusso continuo per lavabo con copertura in ceramica Euro 72,00  
P125 - click-clack drain or open outlet drain for washbasin with ceramic cover Euro 72,00

**SIFONE**  
P82 - sifone CROMO per lavabo Euro 90,00  
P82 - CHROMED trap for washbasin Euro 90,00

ARTICOLO D31 — 37 kg   8 pz pallet Italia   12 pz pallet Export		euro
BIANCO LUCIDO	 001 bianco lucido white	395
COLORI DISPONIBILI	 009 nero lucido black shine	570
DECORI DISPONIBILI	 013 bianco/oro white/gold	680
DECORO NERO/ORO	 020 nero/oro black/gold	840

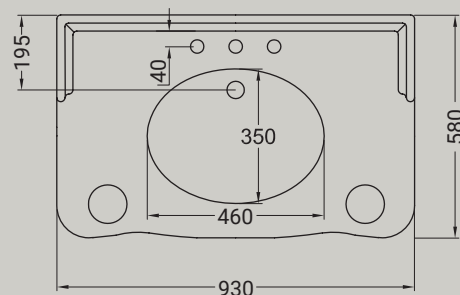
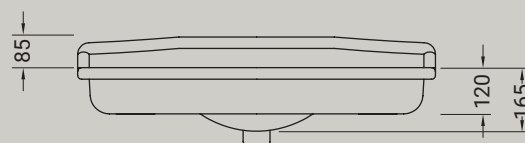

## ELLADE

consolle cm 112 monoforo predisposto 3 fori  
consolle cm 112 1 th (3 th)



Accessori disponibili non inclusi/  
Available accessories not included  
art.P22 - P82 - P125

**FISSAGGIO**  
P22 - sistema di fissaggio per lavabi sospesi  
per muro portante Euro 10,00  
P22 - fixing kit for wall-hung washbasin for  
load-bearing wall Euro 10,00

**PILETTA**  
P125 - piletta click-clack o flusso continuo per  
lavabo con copertura in ceramica Euro 72,00  
P125 - click-clack drain or open outlet drain for washbasin with  
ceramic cover Euro 72,00

**SIFONE**  
P82 - sifone CROMO per lavabo Euro 90,00  
P82 - CHROMED trap for washbasin Euro 90,00

**ARTICOLO D30** — 45,5 kg | 6 pz pallet Italia | 9 pz pallet Export euro

**BIANCO LUCIDO**  **001**  
bianco lucido  
white 415

**COLORI DISPONIBILI**  **009**  
nero lucido  
black shine 600

**DECORI DISPONIBILI**  **013**  
bianco/oro  
white/gold 710

**DECORO NERO/ORO**  **020**  
nero/oro  
black/gold 880

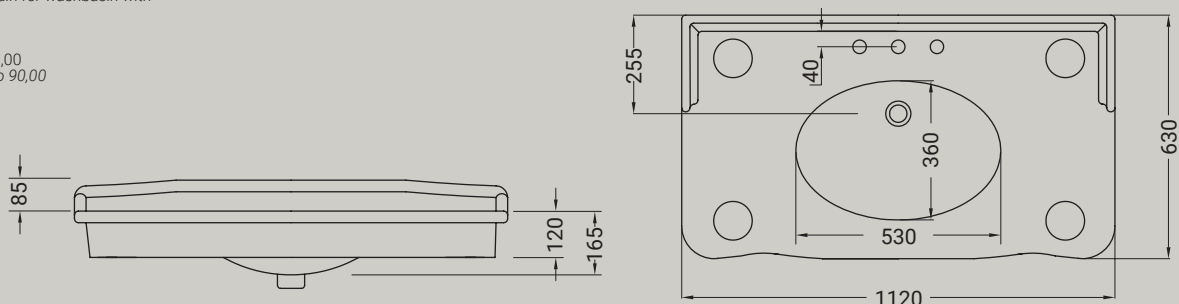

## ELLADE

gamba per consolle  
leg for D30 / D31



**ARTICOLO D32** — 3,6 kg euro

**BIANCO LUCIDO**  **001**  
bianco lucido  
white 172

**COLORI DISPONIBILI**  **009**  
nero lucido  
black shine 260

**DECORI DISPONIBILI**  **015**  
bianco/oro  
white/gold 290

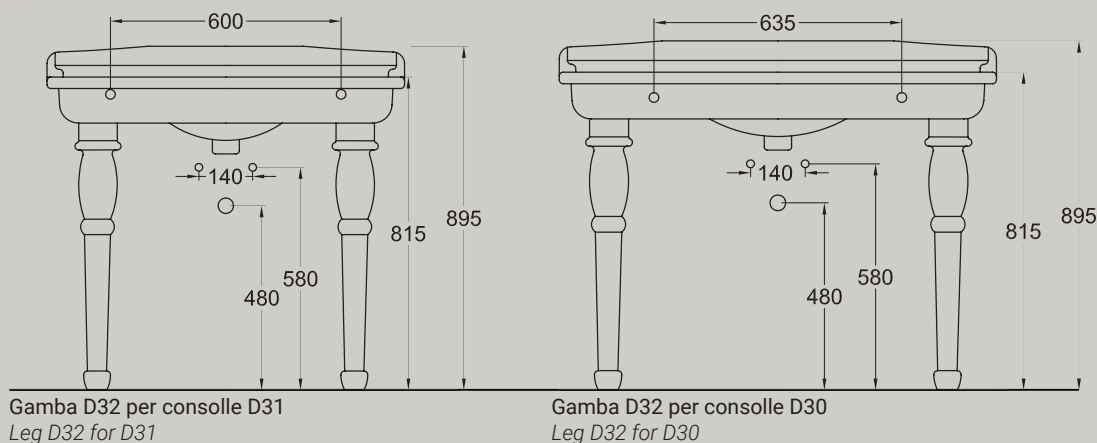



**ELLADE**

gamba slim per D30/D31  
leg slim for D30/D31



ARTICOLO D35 — 3,6 kg		euro
BIANCO LUCIDO	001 bianco lucido white	172
COLORI DISPONIBILI	009 nero lucido black shine	260
DECORI DISPONIBILI	015 bianco/oro white/gold	290

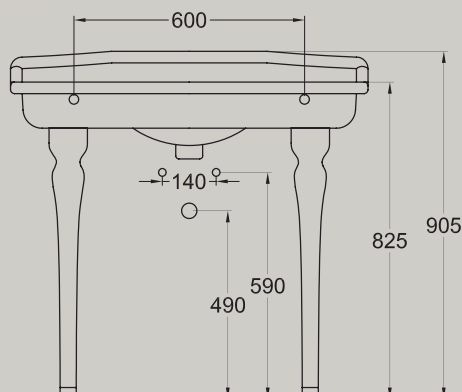

Gamba D35 per consolle D31  
Leg D35 for D31

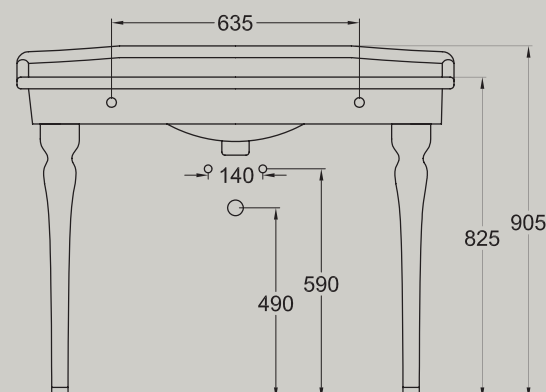

Gamba D35 per consolle D30  
Leg D35 for D30

**ELLADE**

struttura lavabo 68 CROMO, BRONZO, ORO  
structure for wash basin 68, CHROME,  
BRONZE, GOLD



STRUTTURA CONSOLLE 68 — 10 kg		euro
ARTICOLO V108CR	cromo/chrome	1150
ARTICOLO V108BR	bronzo/bronze	1450
ARTICOLO V108O	oro/gold	1450

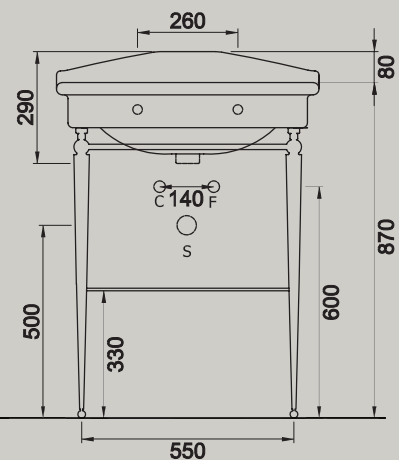

**ELLADE**

struttura consolle 92 CROMO,  
BRONZO, ORO  
structure for consolle 92, CHROME,  
BRONZE, GOLD



**STRUTTURA CONSOLLE 92 – 12 kg**

euro

**ARTICOLO  
V110CR**



cromo/chrome

1550

**ARTICOLO  
V110BR**



bronzo/bronze

1900

**ARTICOLO  
V1100**



oro/gold

1900

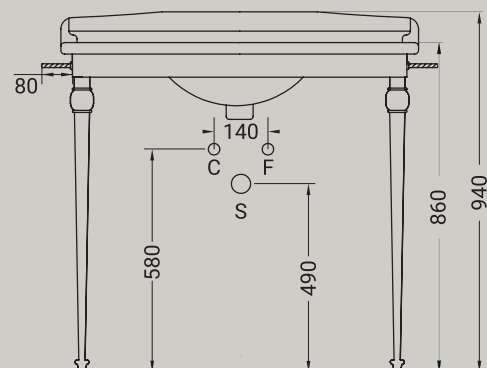

**ELLADE**

struttura consolle 112 CROMO,  
BRONZO, ORO  
structure for consolle 112, CHROME,  
BRONZE, GOLD



**STRUTTURA CONSOLLE 112 – 13 kg**

euro

**ARTICOLO  
V109CR**



cromo/chrome

1450

**ARTICOLO  
V109BR**



bronzo/bronze

1800

**ARTICOLO  
V1090**



oro/gold

1800

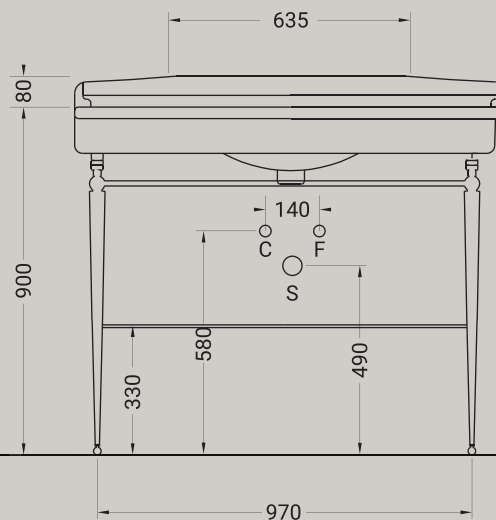



**ELLADE**

struttura in legno nero + consolle 93 (D31)  
 structure in black wood + console 93 (D31)



**ARTICOLO D99** — 51,9 kg

euro

**LEGNO  
 NERO**

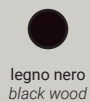

1200

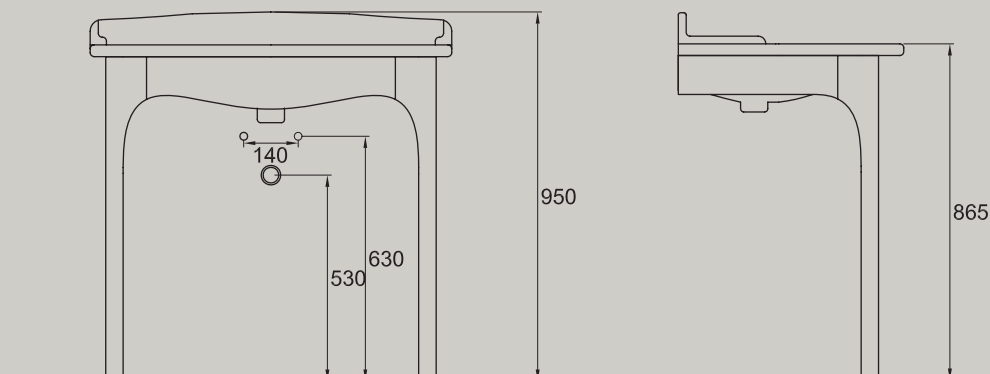

**ELLADE**

vasca ellade piedini BIANCO, CROMO,  
 BRONZO, ORO  
 ellade bathtub with WHITE, CHROME,  
 BRONZE, GOLD, LEGS



**VASCA ELLADE** — 40 kg

euro

**ARTICOLO  
 D60**



2600

**ARTICOLO  
 D61**



2600

**ARTICOLO  
 D62**



2900

**ARTICOLO  
 D63**



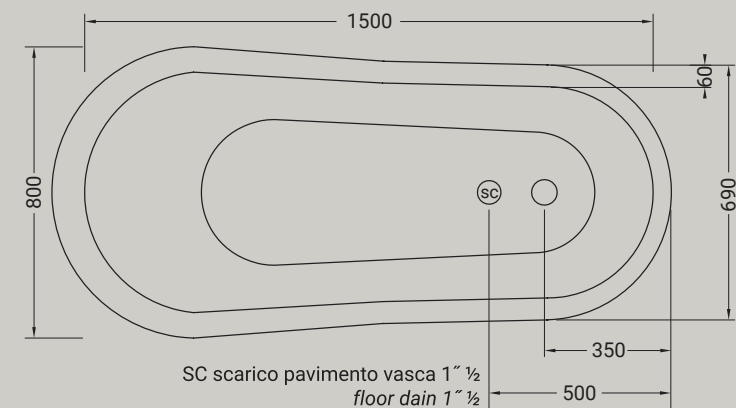
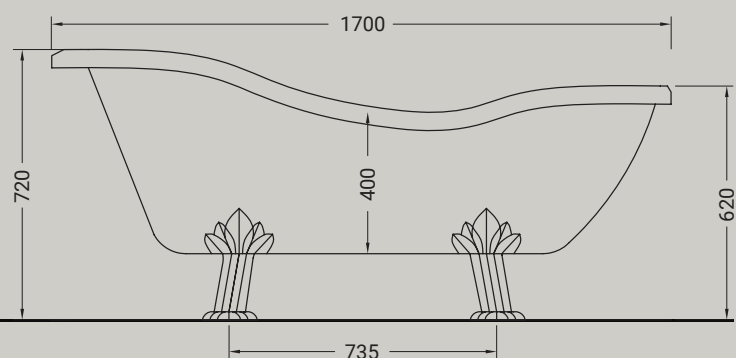

2900



**ELLADE**

victoria porta sapone parete CROMO,  
BRONZO, ORO  
victoria soap holder CHROME, BRONZE,  
GOLD





PORTA SAPONE PARETE – 0,2 kg		euro
<b>ARTICOLO VI67CR</b>	 cromo/chrome	70
<b>ARTICOLO VI67BR</b>	 bronzo/bronze	85
<b>ARTICOLO VI67O</b>	 oro/gold	85

**ELLADE**

victoria porta bicchiere parete CROMO,  
BRONZO, ORO  
victoria glass holder CHROME, BRONZE,  
GOLD





PORTA BICCHIERE PARETE – 0,2 kg		euro
<b>ARTICOLO VI57CR</b>	 cromo/chrome	70
<b>ARTICOLO VI57BR</b>	 bronzo/bronze	90
<b>ARTICOLO VI57O</b>	 oro/gold	90

**ELLADE**

victoria porta carta CROMO, BRONZO, ORO  
victoria toilet roll holder CHROME, BRONZE,  
GOLD





PORTA CARTA – 0,2 kg		euro
<b>ARTICOLO VI66CR</b>	 cromo/chrome	85
<b>ARTICOLO VI66BR</b>	 bronzo/bronze	90
<b>ARTICOLO VI66O</b>	 oro/gold	90



**ELLADE**

victoria porta scopino CROMO,  
BRONZO, ORO  
victoria brush holder CHROME,  
BRONZE, GOLD





PORTA SCOPINO – 2,0 kg		euro
<b>ARTICOLO VI56CR</b>	 cromo/chrome	140
<b>ARTICOLO VI56BR</b>	 bronzo/bronze	160
<b>ARTICOLO VI56O</b>	 001 oro/gold	160

**ELLADE**

victoria porta salviette cm 40 CROMO,  
BRONZO, ORO  
victoria toilet rail CHROME, BRONZE, GOLD





PORTA SALVIETTE CM 40 – 1,0 kg		euro
<b>ARTICOLO VI40CR</b>	 cromo/chrome	130
<b>ARTICOLO VI40BR</b>	 bronzo/bronze	150
<b>ARTICOLO VI40O</b>	 oro/gold	150

**ELLADE**

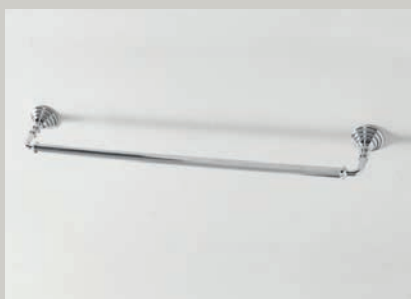
victoria porta salviette cm 60 CROMO,  
BRONZO, ORO  
victoria toilet rail CHROME, BRONZE, GOLD





PORTA SALVIETTE CM 60 – 1,0 kg		euro
<b>ARTICOLO VI60CR</b>	 cromo/chrome	140
<b>ARTICOLO VI60BR</b>	 bronzo/bronze	160
<b>ARTICOLO VI60O</b>	 oro/gold	160

### ELLADE

victoria appendiabiti CROMO,  
BRONZO, ORO  
*victoria hook CHROME, BRONZE, GOLD*





APPENDIABITI – 0,2 kg		euro
<b>ARTICOLO VI68CR</b>	 cromo/chrome	60
<b>ARTICOLO VI68BR</b>	 bronzo/bronze	70
<b>ARTICOLO VI68O</b>	 oro/gold	70

### ELLADE

victoria applique BIANCO/CROMO,  
BIANCO/BRONZO, BIANCO/ORO  
*victoria applique WHITE/CHROME, WHITE/  
BRONZE, WHITE/GOLD*





APPLIQUE BIANCA – 1,5 kg		euro
<b>ARTICOLO VI69CR</b>	 bianco/cromo white/chrome	270
<b>ARTICOLO VI69BR</b>	 bianco/bronzo white/bronze	300
<b>ARTICOLO VI69O</b>	 bianco/oro white/gold	300

### ELLADE

victoria applique NERO/CROMO, NERO/  
BRONZO, NERO/ORO  
*victoria applique black/chrome, BLACK/  
BRONZE, BLACK/GOLD*



APPLIQUE NERA – 1,5 kg		euro
<b>ARTICOLO VI70CR</b>	 nero/cromo black/chrome	270
<b>ARTICOLO VI70BR</b>	 nero/bronzo black/bronze	300
<b>ARTICOLO VI70O</b>	 nero/oro black/gold	300

## ELLADE

italiana specchio con cornice bianca, nera,  
argento invecchiato, oro invecchiato  
*italiana framed mirror white, black, silver, gold*



### SPECCHIO CON CORNICE – 8,0 kg

euro

ARTICOLO  
VI166B



bianco/*white*

450

ARTICOLO  
VI166N



nero/*black*

450

ARTICOLO  
VI166A



argento invecchiato  
*aged silver*

450

ARTICOLO  
VI166O



oro invecchiato  
*aged gold*

450



**FASTER**

# FASTER

## WC

### **FART40**

37x53 cm



### **FAWR20**

37x53 cm



### **FAR12**

68x37 cm



## BIDET

### **FA14**

37x53 cm



### **FAW14**

37x53 cm



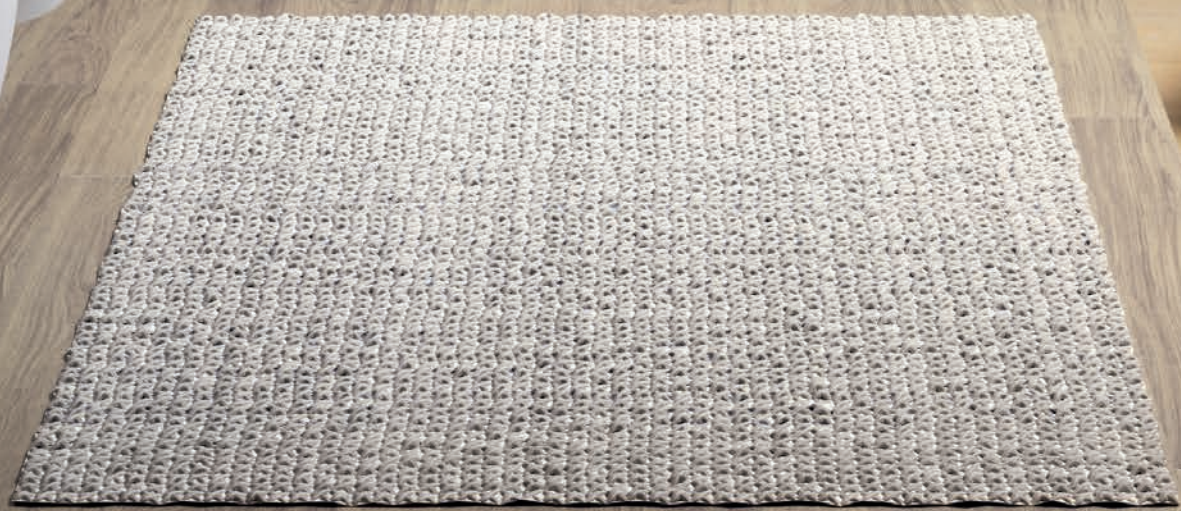



HIDRA

design Hidra Ceramica



# FASTER

MADE IN ITALY

**Usufruire di un bagno contemporaneo sin dal risveglio e rivivere ogni giorno la bellezza dell'essenzialità. Ecco il vantaggio della collezione Faster, che grazie alla robustezza delle curve e alla raffinatezza delle linee nette, dona proporzione e semplicità al luogo più intimo della casa. In questo modo viene alla luce un paesaggio in cui il benessere si sposa con il comfort in un' esultanza di bellezza che dura nel tempo.**

*Enjoy a contemporary bathroom from the beginning and, relive every day the beauty of the essential. Here is the advantage of Faster collection, thanks to its robustness of the curves and the sophistication of the sharp lines, gives proportion and simplicity to the most intimate place of the house. In this way a landscape comes to light in which the marries with comfort in an exultation of beauty that lasts over time wellness.*





















006  
BIANCO MATT  
*white matt*



026  
NERO MATT  
*black matt*



053  
GRIGIO MATT  
*grey matt*



096  
MARRONE MATT  
*brown matt*



052  
VERDE MATT  
*green matt*



097  
ROSA MATT  
*pink matt*





HIDRA — FASTER







001  
BIANCO LUCIDO



009  
SHINE BLACK



108  
SHINE GREY



105  
SHINE RED



106  
SHINE GREEN



109  
SHINE YELLOW



107  
SHINE BLU



116  
SHINE PINK

## FASTER

vaso sospeso senza brida + kit fissaggio  
wc wall hung rimless + fixing kit



Accessori disponibili non inclusi/  
Available accessories not included  
art. P81

RACCORDO  
P81 - raccordo di scarico parete Euro 25,00  
P81 - horizontal outlet plastic pipe Euro 25,00

ARTICOLO FAWR20		23 kg   12 pz pallet Italia   20 pz pallet Export	euro
BIANCO LUCIDO		001	320
		bianco lucido white	
COLORI DISPONIBILI		006	480
		026	
		053	
		096	
		052	
		097	
		009	
		106	
		108	
		105	
		109	
		107	
		116	
		shine black	
	shine green		
	shine grey		
	shine red		
	shine yellow		
	shine blu		
	shine pink		

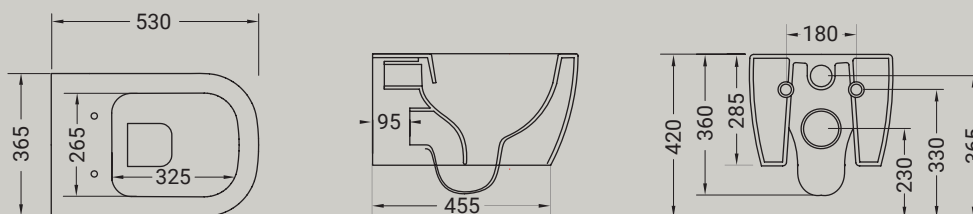















## FASTER

bidet sospeso + kit fissaggio  
wall hung bidet + fixing kit



Accessori disponibili non inclusi/  
Available accessories not included  
art. P91

SIFONE  
P91 - sifone ribassato per bidet Euro 80,00  
P91 - CHROMED trap for washbasin Euro 80,00

ARTICOLO FAW14		19 kg   12 pz pallet Italia   20 pz pallet Export	euro
BIANCO LUCIDO		001	320
		bianco lucido white	
COLORI DISPONIBILI		006	480
		026	
		053	
		096	
		052	
		097	
		009	
		106	
		108	
		105	
		109	
		107	
		116	
		shine black	
	shine green		
	shine grey		
	shine red		
	shine yellow		
	shine blu		
	shine pink		

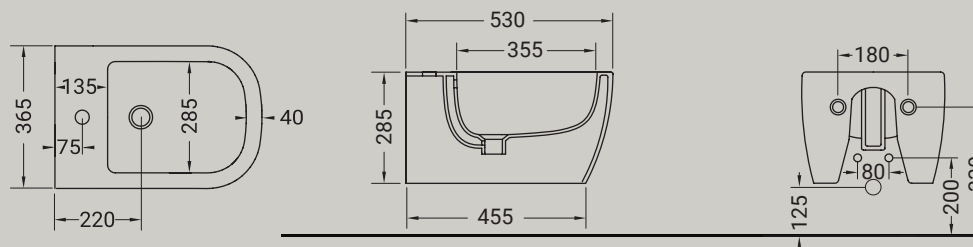



**FASTER**

vaso terra filomuro rimless traslato + kit fissaggio  
*wc back to wall rimless adjustable flush + fixing kit*

Accessori disponibili non inclusi/  
*Available accessories not included*  
 art.P57 - P59 - P60 - P61 - P81



**A\***  
**CURVE SCARICO PAVIMENTO**  
 curva P59 - scarico regolabile da 60 a 110 Euro 30,00  
 curva P57 - scarico regolabile da 120 a 150 Euro 25,00  
 curva P60 - scarico regolabile da 160 a 200 Euro 30,00

**VERTICAL OUTLET PLASTIC PIPE**  
 vertical outlet P59 - adjustable 60-110 Euro 30,00  
 vertical outlet P57 - adjustable 120-150 Euro 25,00  
 vertical outlet P60 - adjustable 160-200 Euro 30,00

**B\*\***  
**RACCORDO CARICO ACQUA / PIPE INLET WATER**  
 P61 - regolabile 325 o 365 Euro 30,00  
 P61 - djustable 325 or 365 Euro 30,00

**RACCORDO**  
 P81 - raccordo di scarico parete Euro 25,00  
 P81 - horizontal outlet plastic pipe Euro 25,00

**ARTICOLO FART40** — 25 kg | 10 pz pallet Italia | 20 pz pallet Export

euro

<b>BIANCO LUCIDO</b>		<b>001</b>						320						
		bianco lucido <i>white</i>												
<b>COLORI DISPONIBILI</b>		<b>006</b>		<b>026</b>		<b>053</b>		<b>096</b>		<b>052</b>		480		
		bianco matt <i>white matt</i>	nero matt <i>black matt</i>	grigio matt <i>grey matt</i>	marrone matt <i>brown matt</i>	verde matt <i>green matt</i>	rosa matt <i>pink matt</i>							
		<b>009</b>		<b>106</b>		<b>108</b>		<b>105</b>		<b>109</b>		<b>107</b>		<b>116</b>
		shine black	shine green	shine grey	shine red	shine yellow	shine blu	shine pink						

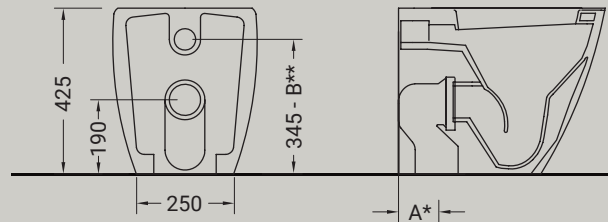
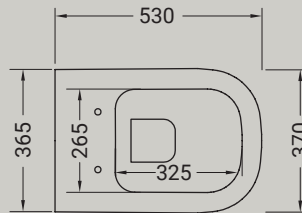

**FASTER**

bidet terra filomuro + kit fissaggio  
*back to wall bidet + fixing kit*



**ARTICOLO FA14** — 22 kg | 10 pz pallet Italia | 20 pz pallet Export

euro

<b>BIANCO LUCIDO</b>		<b>001</b>						320						
		bianco lucido <i>white</i>												
<b>COLORI DISPONIBILI</b>		<b>006</b>		<b>026</b>		<b>053</b>		<b>096</b>		<b>052</b>		480		
		bianco matt <i>white matt</i>	nero matt <i>black matt</i>	grigio matt <i>grey matt</i>	marrone matt <i>brown matt</i>	verde matt <i>green matt</i>	rosa matt <i>pink matt</i>							
		<b>009</b>		<b>106</b>		<b>108</b>		<b>105</b>		<b>109</b>		<b>107</b>		<b>116</b>
		shine black	shine green	shine grey	shine red	shine yellow	shine blu	shine pink						

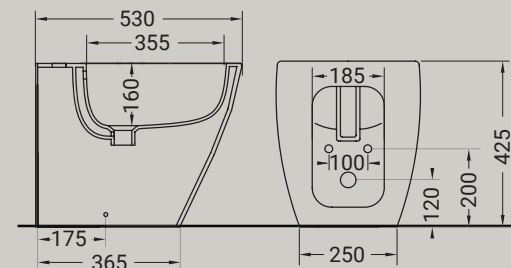
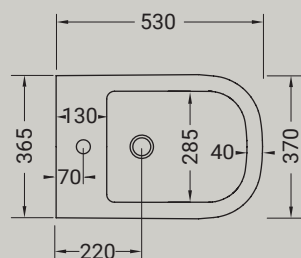

**FASTER**

vaso monoblocco rimless traslato  
+ kit fissaggio  
*close coupled wc rimless adjustable flushing  
+ fixing kit*



**A\***  
**CURVE SCARICO PAVIMENTO**  
curva P59 - scarico regolabile da 100 a 245 Euro 30,00  
curva P57 - scarico regolabile - 250 Euro 25,00  
curva P60 - scarico regolabile da 240 a 300 Euro 30,00

**VERTICAL OUTLET PLASTIC PIPE**  
vertical outlet P59 - adjustable 100-245 Euro 30,00  
vertical outlet P57 - adjustable -250 Euro 25,00  
vertical outlet P60 - adjustable 240-300 Euro 30,00

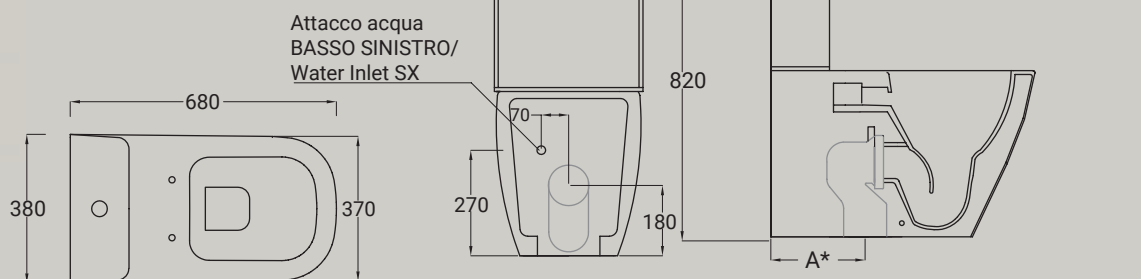

<b>ARTICOLO FAR12</b> — 33 kg   6 pz pallet Italia   9 pz pallet Export		euro
<b>BIANCO LUCIDO</b>	<b>001</b> bianco lucido white	370
<b>COLORI DISPONIBILI</b>	<b>006</b> bianco matt white matt <b>026</b> nero matt black matt <b>053</b> grigio matt grey matt <b>096</b> marrone matt brown matt <b>052</b> verde matt green matt <b>097</b> rosa matt pink matt	550
	<b>009</b> shine black <b>106</b> shine green <b>108</b> shine grey <b>105</b> shine red <b>109</b> shine yellow <b>107</b> shine blu <b>116</b> shine pink	

**FASTER**

cassetta monoblocco  
*ceramic cistern*



Accessori disponibili non inclusi/  
*Available accessories not included*  
art. P7576

**MECCANISMO**  
P7576 - scarico doppio flusso geberit entratya acqua bassa o alta Euro 90,00  
P7576 - geberit dual flushing system low high water inlet Euro 90,00

<b>ARTICOLO FA18 – CASSETTA MB PER FAR12 / MB CISTERN FOR FAR12</b> — 14 kg		euro
<b>BIANCO LUCIDO</b>	<b>001</b> bianco lucido white	140
<b>COLORI DISPONIBILI</b>	<b>006</b> bianco matt white matt <b>026</b> nero matt black matt <b>053</b> grigio matt grey matt <b>096</b> marrone matt brown matt <b>052</b> verde matt green matt <b>097</b> rosa matt pink matt	210
	<b>009</b> shine black <b>106</b> shine green <b>108</b> shine grey <b>105</b> shine red <b>109</b> shine yellow <b>107</b> shine blu <b>116</b> shine pink	

**FASTER**

coprivaso slim a caduta rallentata  
e sgancio rapido  
*slim seat cover soft-close quick release*





<b>ARTICOLO FAZQ</b> — 3 kg		euro
<b>BIANCO LUCIDO</b>	<b>001</b> bianco lucido white	150
<b>COLORI DISPONIBILI</b>	<b>006</b> bianco matt white matt <b>026</b> nero matt black matt <b>053</b> grigio matt grey matt <b>096</b> marrone matt brown matt <b>052</b> verde matt green matt <b>097</b> rosa matt pink matt	225
	<b>009</b> shine nero shine black <b>106</b> shine green <b>108</b> shine grey <b>105</b> shine red <b>109</b> shine yellow <b>107</b> shine blu <b>116</b> shine pink	

**FASTER**

vasca in solid surface bianca  
 lucida e opaca  
*bathub in solid surface white shine  
 and matt*



<b>ARTICOLO FV61</b> - 151,0 kg		euro
<b>ARTICOLO FV61L</b>	 001 bianco lucido <i>white shine</i>	3900
<b>ARTICOLO FV61O</b>	 006 bianco matt <i>white matt</i>	3900

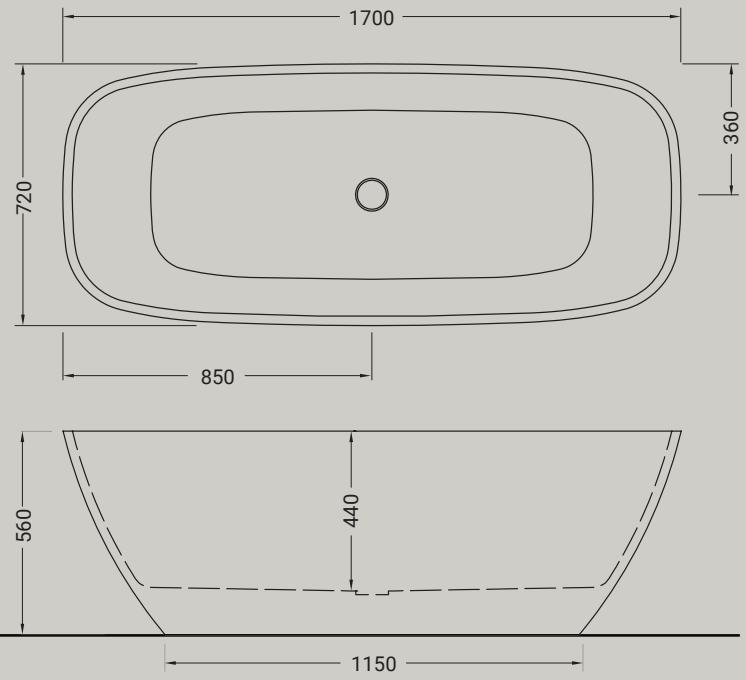



**KIUB**

# KIUB

## WC

### KIR20

36,5X54 cm



### KIWR20

36,5X54 cm



## BIDET

### KI14

36,5X54 cm



### KIW14

36,5X54 cm



## LAVABI

### KI50

51X46 cm



### KI60

61x46 cm



### KI80

81x46 cm



### KI100

101x46 cm



### KI100DX

101x46 cm



### KI100SX

101x46 cm



### KI120

122x46 cm



### KI120DV

122x46 cm











# KIUB

MADE IN ITALY

Una collezione rigorosa che si inserisce in un bagno contemporaneo orientato al design. Linee solide, di straordinaria leggerezza si avvicendano attraverso undici lavabi, dando vita ad ambienti diversi contraddistinti dal rigore, dallo spazio e linee armoniose. L'elemento caratterizzante di Kiub è l'ampia gamma di misure offerte, che possono essere usate singolarmente o in composizioni multiple. Undici soluzioni sapientemente differenziate, pensate per ambienti sempre nuovi, ora giocati sull'importanza di un lavabo ad una o due vasche di grandi dimensioni, ora sulla modularità e la ripetizione dei lavabi quadrati in sequenze geometriche.

*A rigorous collection of basins that perfectly blend in a contemporary design-oriented bathroom. Solid and extremely soft lines presented in eleven basins for various bathroom areas characterized by formal rigour, space and balanced lines. The core element of Kiub is the large range of measures that can be used in unique or multiple solutions. Eleven basins wisely differentiated, conceived for various areas, singularly or with one or two big basins playing with modularity or repetition of square basins in geometrical sequences.*































006  
BIANCO MATT  
*white matt*



026  
NERO MATT  
*black matt*



053  
GRIGIO MATT  
*grey matt*



096  
MARRONE MATT  
*brown matt*



052  
VERDE MATT  
*green matt*



097  
ROSA MATT  
*pink matt*













020  
NERO/ORO  
*black/gold*



013  
BIANCO/ORO  
*white/gold*



014  
BIANCO/PLATINO  
*white/platinum*



100  
CEPPO DI GRÈ  
*grey*



101  
white  
*marble*



103  
GREEN ALPES  
*marble*

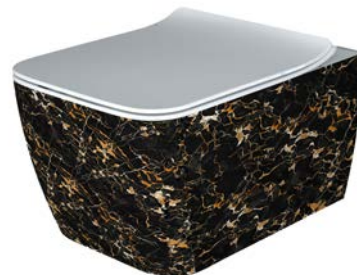

104  
BLACK GOLD  
*marble*





100  
CEPPO DI GRÈ  
*grey*



101  
white matt  
*marble*



103  
GREEN ALPES  
*marble*



104  
BLACK GOLD  
*marble*







**KIUB**



vaso sospeso senza brida + kit fissaggio  
wc rimless wall hung + fixing kit







**ARTICOLO KIWR20** — 24 kg | 12 pz pallet Italia | 20 pz pallet Export euro

<b>BIANCO LUCIDO</b>	 <b>001</b> bianco lucido white	<b>340</b>
----------------------	---	------------

<b>COLORI DISPONIBILI</b>	<div style="text-align: center;">   <b>006</b>                  bianco matt white matt             </div> <div style="text-align: center;">   <b>026</b>                  nero matt black matt             </div> <div style="text-align: center;">   <b>053</b>                  grigio matt grey matt             </div> <div style="text-align: center;">   <b>052</b>                  verde matt green matt             </div> <div style="text-align: center;">   <b>096</b>                  marrone matt brown matt             </div> <div style="text-align: center;">   <b>097</b>                  rosa matt pink matt             </div>	<b>510</b>
---------------------------	---	------------

<b>DECORI DISPONIBILI</b>	<div style="text-align: center;">   <b>013</b>                  bianco/oro white/gold             </div> <div style="text-align: center;">   <b>014</b>                  bianco/platino white/platinum             </div> <div style="text-align: center; width: 100px;"><b>790</b></div> <div style="text-align: center;">   <b>DECORO NERO/ORO</b>  <b>020</b>                  nero/oro black/gold             </div>	<b>960</b>
---------------------------	---	------------

<b>TEXTURE DISPONIBILI</b>	<div style="text-align: center;">   <b>100</b>                  ceppo di gré grey             </div> <div style="text-align: center;">   <b>101</b>                  white matt marble             </div> <div style="text-align: center;">   <b>103</b>                  green alpes green alpes             </div> <div style="text-align: center;">   <b>104</b>                  black gold marble             </div>	<b>610</b>
----------------------------	---	------------

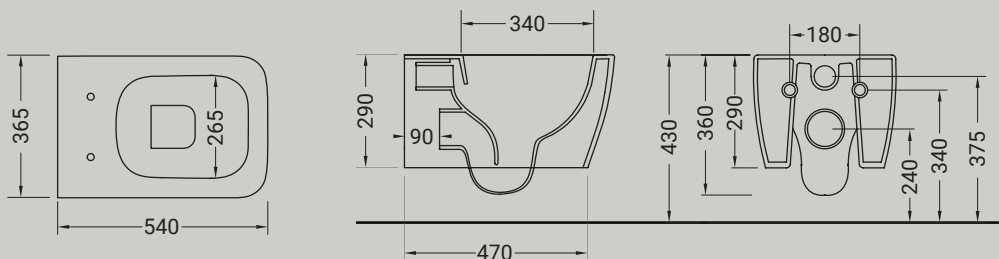

**KIUB**

bidet sospeso + kit fissaggio  
bidet wall hung + fixing kit





Accessori disponibili non inclusi/  
Available accessories not included  
art.P91



**SIFONE**  
P91 - sifone ribassato per bidet Euro 80,00  
P91 - CHROMED trap for washbasin Euro 80,00

**ARTICOLO KIW14** — 21kg | 12 pz pallet Italia | 20 pz pallet Export euro

<b>BIANCO LUCIDO</b>	 <b>001</b> bianco lucido white	<b>340</b>
----------------------	---	------------

<b>COLORI DISPONIBILI</b>	<div style="text-align: center;">   <b>006</b>                  bianco matt white matt             </div> <div style="text-align: center;">   <b>026</b>                  nero matt black matt             </div> <div style="text-align: center;">   <b>053</b>                  grigio matt grey matt             </div> <div style="text-align: center;">   <b>052</b>                  verde matt green matt             </div> <div style="text-align: center;">   <b>096</b>                  marrone matt brown matt             </div> <div style="text-align: center;">   <b>097</b>                  rosa matt pink matt             </div>	<b>510</b>
---------------------------	---	------------

<b>DECORI DISPONIBILI</b>	<div style="text-align: center;">   <b>013</b>                  bianco/oro white/gold             </div> <div style="text-align: center;">   <b>014</b>                  bianco/platino white/platinum             </div> <div style="text-align: center; width: 100px;"><b>790</b></div> <div style="text-align: center;">   <b>DECORO NERO/ORO</b>  <b>020</b>                  nero/oro black/gold             </div>	<b>960</b>
---------------------------	---	------------

<b>TEXTURE DISPONIBILI</b>	<div style="text-align: center;">   <b>100</b>                  ceppo di gré grey             </div> <div style="text-align: center;">   <b>101</b>                  white matt marble             </div> <div style="text-align: center;">   <b>103</b>                  green alpes green alpes             </div> <div style="text-align: center;">   <b>104</b>                  black gold marble             </div>	<b>610</b>
----------------------------	---	------------

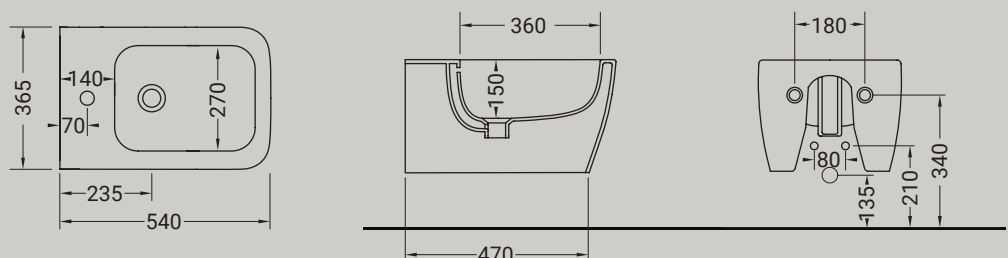



**KIUB**

vaso a terra senza brida traslato filo parete + kit fissaggio ghost  
wc rimless adjustable flush back to wall + ghost fixing

Accessori disponibili non inclusi/  
Available accessories not included  
art.P57 - P59 - P60 -P61 - P81



**A\***  
CURVE SCARICO PAVIMENTO  
curva P59 - scarico regolabile da 60 a 110 Euro 30,00  
curva P57 - scarico regolabile da 120 a 150 Euro 25,00  
curva P60 - scarico regolabile da 160 a 190 Euro 30,00

VERTICAL OUTLET PLASTIC PIPE  
vertical outlet P59 - adjustable 60-110 Euro 30,00  
vertical outlet P57 - adjustable 120-150 Euro 25,00  
vertical outlet P60 - adjustable 160-190 Euro 30,00

**B\*\***  
RACCORDO CARICO ACQUA / PIPE INLET WATER  
P61 - regolabile 325 o 365 Euro 25,00  
P61 - adjustable 325 or 365 Euro 25,00

RACCORDO  
P81 - raccordo di scarico parete Euro 25,00  
P81 - horizontal outlet plastic pipe Euro 25,00

**ARTICOLO KIR20** — 31 kg | 10 pz pallet Italia | 20 pz pallet Export euro

BIANCO LUCIDO	 <b>001</b> bianco lucido white	340
---------------	--	-----

COLORI DISPONIBILI	 <b>006</b> bianco matt white matt	 <b>026</b> nero matt black matt	 <b>053</b> grigio matt grey matt	 <b>052</b> verde matt green matt	 <b>096</b> marrone matt brown matt	 <b>097</b> rosa matt pink matt	510
--------------------	---	---	--	--	--	--	-----

DECORI DISPONIBILI	 <b>013</b> bianco/oro white/gold	 <b>014</b> bianco/platino white/platinum	790	DECORO NERO/ORO	 <b>020</b> nero/oro black/gold	960
--------------------	--	--	-----	-----------------	--	-----

TEXTURE DISPONIBILI	 <b>100</b> ceppo di gré grey	 <b>101</b> white matt marble	 <b>103</b> green alpes green alpes	 <b>104</b> black gold marble	610
---------------------	--	--	--	--	-----

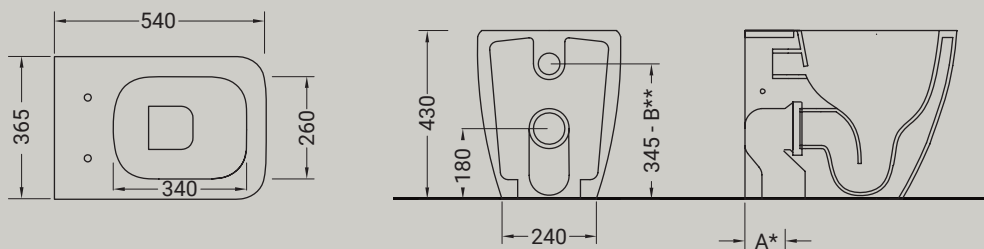

**KIUB**

bidet filomuro + kit fissaggio ghost  
bidet back to wall + ghost fixing



**ARTICOLO KI14** — 28 kg | 10 pz pallet Italia | 20 pz pallet Export euro

BIANCO LUCIDO	 <b>001</b> bianco lucido white	340
---------------	--	-----

COLORI DISPONIBILI	 <b>006</b> bianco matt white matt	 <b>026</b> nero matt black matt	 <b>053</b> grigio matt grey matt	 <b>052</b> verde matt green matt	 <b>096</b> marrone matt brown matt	 <b>097</b> rosa matt pink matt	510
--------------------	---	---	--	--	--	--	-----

DECORI DISPONIBILI	 <b>013</b> bianco/oro white/gold	 <b>014</b> bianco/platino white/platinum	790	DECORO NERO/ORO	 <b>020</b> nero/oro black/gold	960
--------------------	--	--	-----	-----------------	--	-----



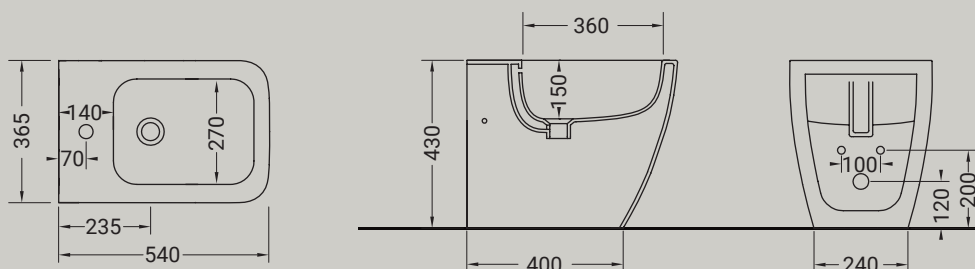





TEXTURE DISPONIBILI	 <b>100</b> ceppo di gré grey	 <b>101</b> white matt marble	 <b>103</b> green alpes green alpes	 <b>104</b> black gold marble	610
---------------------	--	--	--	--	-----



## KIUB

coprivaso slim a caduta rallentata e sgancio rapido  
*slim seat cover soft-close quick release*



ARTICOLO KIZQ — 2,8 kg		euro
BIANCO LUCIDO	 001 bianco lucido white	150
COLORI DISPONIBILI	      	225
	006 bianco matt white matt 026 nero matt black matt 053 grigio matt grey matt 096 marrone matt brown matt 052 verde matt green matt 097 rosa matt pink matt 009 shine nero shine black	

## KIUB

lavabo sospeso/appoggio monoforo su richiesta 3 fori  
*wash basin wall hung/countertop 1th 3 th on demand*



ARTICOLO KI50 — 14 kg   20 pz pallet Italia   34 pz pallet Export		euro
BIANCO LUCIDO	 001 bianco lucido white	270
COLORI DISPONIBILI	     	405
TEXTURE DISPONIBILI	   	500
	100 ceppo di gré grey 101 white matt marble 103 green alpes green alpes 104 black gold marble	

Accessori disponibili non inclusi/  
*Available accessories not included*  
 art.P22 - P82 - P85 - P125

**FISSAGGIO**  
 P85 - sistema fissaggio per lavabi appoggio Euro 10,00  
 P22 - sistema fissaggio per lavabi sospesi per muro portante Euro 10,00

P22 - fi.xing kit for wal-hung washbasin for load-bearing wall Euro 10,00  
 P85 - fixing kit for countertop washbasin Euro 10,00

**PILETTA**  
 P125 - piletta click-clack o flusso continuo per lavabo con copertura in ceramica Euro 72,00  
 P125 - click-clack drain or open outlet drain for washbasin with ceramic cover Euro 72,00

**SIFONE**  
 P82 - sifone CROMO per lavabo Euro 90,00  
 P82 - CHROMED trap for washbasin Euro 90,00

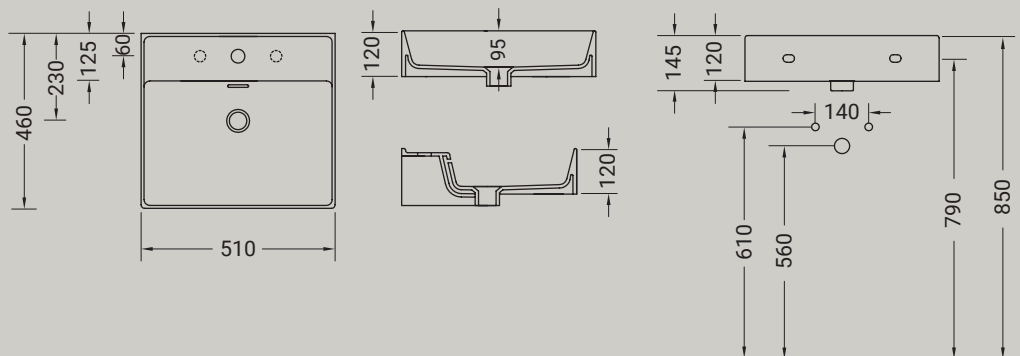



## KIUB

lavabo sospeso/appoggio monoforo  
su richiesta 3 fori  
wash basin wall hung/countertop 1th  
3 th on demand



Accessori disponibili non inclusi/  
Available accessories not included  
art.P22 - P82 - P85 - P125

### FISSAGGIO

P85 - sistema fissaggio per lavabi appoggio Euro 10,00  
P22 - sistema fissaggio per lavabi sospesi  
per muro portante Euro 10,00

P22 - fi xing kit for wal-hung washbasin for load-bearing  
wall Euro 10,00  
P85 - fixing kit for countertop washbasin Euro 10,00

### PILETTA

P125 - piletta click-clack o flusso continuo per  
lavabo con copertura in ceramica Euro 72,00  
P125 - click-clack drain or open outlet drain for washbasin  
with ceramic cover Euro 72,00

### SIFONE

P82 - sifone CROMO per lavabo Euro 90,00  
P82 - CHROMED trap for washbasin Euro 90,00

ARTICOLO KI60		15 kg   20 pz pallet Italia   34 pz pallet Export	euro
BIANCO LUCIDO	001 bianco lucido white		320
COLORI DISPONIBILI	006 bianco matt white matt 026 nero matt black matt 053 grigio matt grey matt 096 marrone matt brown matt 052 verde matt green matt 097 rosa matt pink matt		480
TEXTURE DISPONIBILI	100 ceppo di gré grey 101 white matt marble 103 green alpes green alpes 104 black gold marble		550

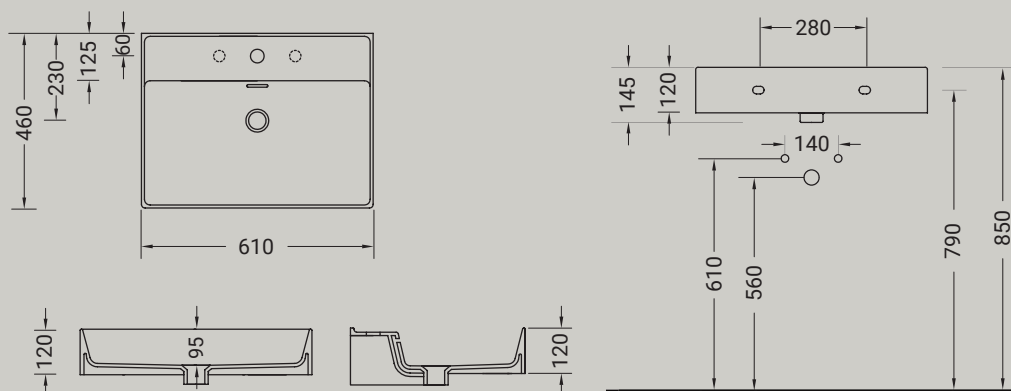

## KIUB

lavabo sospeso/appoggio monoforo  
su richiesta 3 fori  
wash basin wall hung/countertop 1th  
3 th on demand



Accessori disponibili non inclusi/  
Available accessories not included  
art.P22 - P82 - P85 - P125

### FISSAGGIO

P85 - sistema fissaggio per lavabi appoggio Euro 10,00  
P22 - sistema fissaggio per lavabi sospesi  
per muro portante Euro 10,00

P22 - fi xing kit for wal-hung washbasin for load-bearing  
wall Euro 10,00  
P85 - fixing kit for countertop washbasin Euro 10,00

### PILETTA

P125 - piletta click-clack o flusso continuo per  
lavabo con copertura in ceramica Euro 72,00  
P125 - click-clack drain or open outlet drain for washbasin  
with ceramic cover Euro 72,00

### SIFONE

P82 - sifone CROMO per lavabo Euro 90,00  
P82 - CHROMED trap for washbasin Euro 90,00

ARTICOLO KI80		21 kg   14 pz pallet Italia   25 pz pallet Export	euro
BIANCO LUCIDO	001 bianco lucido white		360
COLORI DISPONIBILI	006 bianco matt white matt 026 nero matt black matt 053 grigio matt grey matt 096 marrone matt brown matt 052 verde matt green matt 097 rosa matt pink matt		540
TEXTURE DISPONIBILI	100 ceppo di gré grey 101 white matt marble 103 green alpes green alpes 104 black gold marble		600

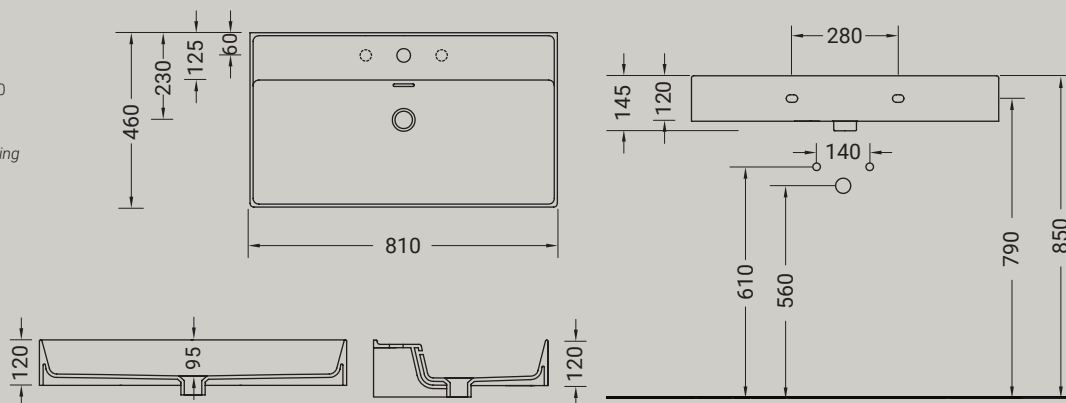

**KIUB**

lavabo appoggio/sospeso  
monoforo o 2 fori su richiesta  
countertop/wall-hung washbasin 1th  
on demand 2 th



Accessori disponibili non inclusi/  
Available accessories not included  
art.P22 - P82 - P85 - P125

**FISSAGGIO**

P85 - sistema fissaggio per lavabi appoggio Euro 10,00  
P22 - sistema fissaggio per lavabi sospesi  
per muro portante Euro 10,00

P22 - fixing kit for wal-hung washbasin for load-bearing  
wall Euro 10,00  
P85 - fixing kit for countertop washbasin Euro 10,00

**PILETTA**







P125 - piletta click-clack o flusso continuo per  
lavabo con copertura in ceramica Euro 72,00  
P125 - click-clack drain or open outlet drain for washbasin with  
ceramic cover Euro 72,00





**SIFONE**

P82 - sifone CROMO per lavabo Euro 90,00  
P82 - CHROMED trap for washbasin Euro 90,00

**ARTICOLO KI100** — 27,5 kg | 12 pz pallet Italia | 22 pz pallet Export euro

**BIANCO LUCIDO**  **001**  
bianco lucido  
white 400

**COLORI DISPONIBILI**  **006**  **026**  **053**  **096**  **052**  **097**  
bianco matt nero matt grigio matt marrone matt verde matt rosa matt  
white matt black matt grey matt brown matt green matt pink matt 600

**TEXTURE DISPONIBILI**  **100**  **101**  **103**  **104**  
ceppo di gré white matt green alpes black gold  
grey marble green alpes marble 650

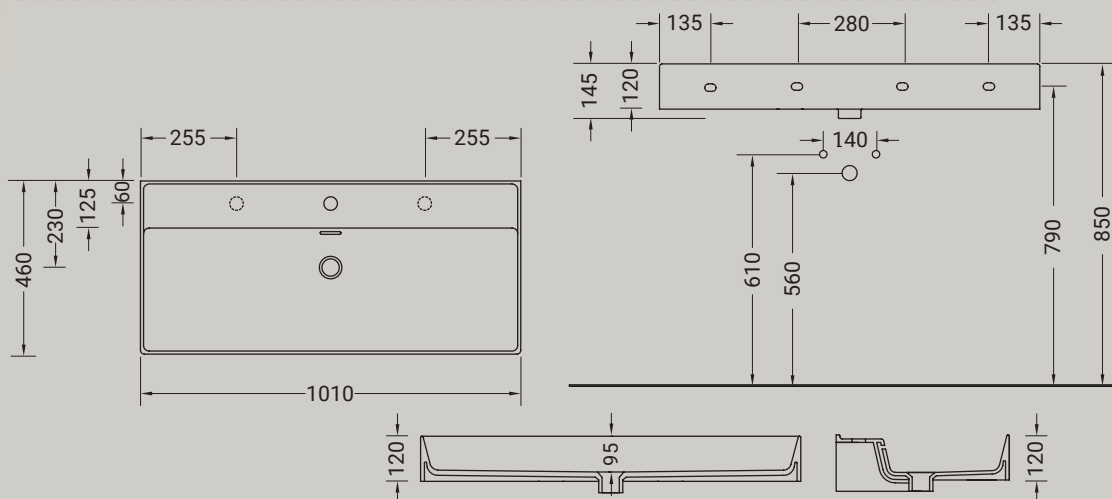

**KIUB**

lavabo sospeso/appoggio monoforo su  
richiesta 3 fori  
wash basin wall hung/countertop 1th  
3 th on demand



Accessori disponibili non inclusi/  
Available accessories not included  
art.P22 - P82 - P85 - P125

**FISSAGGIO**

P85 - sistema fissaggio per lavabi appoggio Euro 10,00  
P22 - sistema fissaggio per lavabi sospesi  
per muro portante Euro 10,00

P22 - fixing kit for wal-hung washbasin for  
load-bearing wall Euro 10,00  
P85 - fixing kit for countertop washbasin Euro 10,00

**PILETTA**







P125 - piletta click-clack o flusso continuo per  
lavabo con copertura in ceramica Euro 72,00  
P125 - click-clack drain or open outlet drain for  
washbasin with ceramic cover Euro 72,00





**SIFONE**

P82 - sifone CROMO per lavabo Euro 90,00  
P82 - CHROMED trap for washbasin Euro 90,00

**ARTICOLO KI100DX** — 26,0 kg | 12 pz pallet Italia | 22 pz pallet Export euro

**BIANCO LUCIDO**  **001**  
bianco lucido  
white 400

**COLORI DISPONIBILI**  **006**  **026**  **053**  **096**  **052**  **097**  
bianco matt nero matt grigio matt marrone matt verde matt rosa matt  
white matt black matt grey matt brown matt green matt pink matt 600

**TEXTURE DISPONIBILI**  **100**  **101**  **103**  **104**  
ceppo di gré white matt green alpes black gold  
grey marble green alpes marble 650

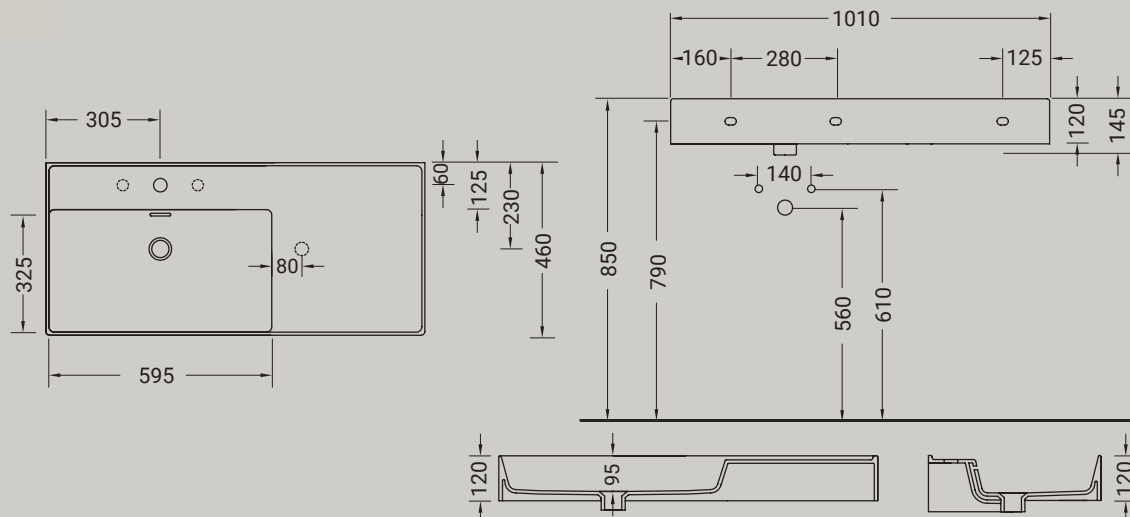

**KIUB**

lavabo sospeso/appoggio monoforo su richiesta 3 fori  
*wash basin wall hung/countertop 1th 3 th on demand*



Accessori disponibili non inclusi/  
*Available accessories not included*  
 art.P22 - P82 - P85 - P125

**FISSAGGIO**  
 P85 - sistema fissaggio per lavabi appoggio Euro 10,00  
 P22 - sistema fissaggio per lavabi sospesi per muro portante Euro 10,00

*P22 - fixing kit for wal-hung washbasin for load-bearing wall Euro 10,00*  
*P85 - fixing kit for countertop washbasin Euro 10,00*

**PILETTA**  
 P125 - piletta click-clack o flusso continuo per lavabo con copertura in ceramica Euro 72,00  
*P125 - click-clack drain or open outlet drain for washbasin with ceramic cover Euro 72,00*

**SIFONE**  
 P82 - sifone CROMO per lavabo Euro 90,00  
*P82 - CHROMED trap for washbasin Euro 90,00*

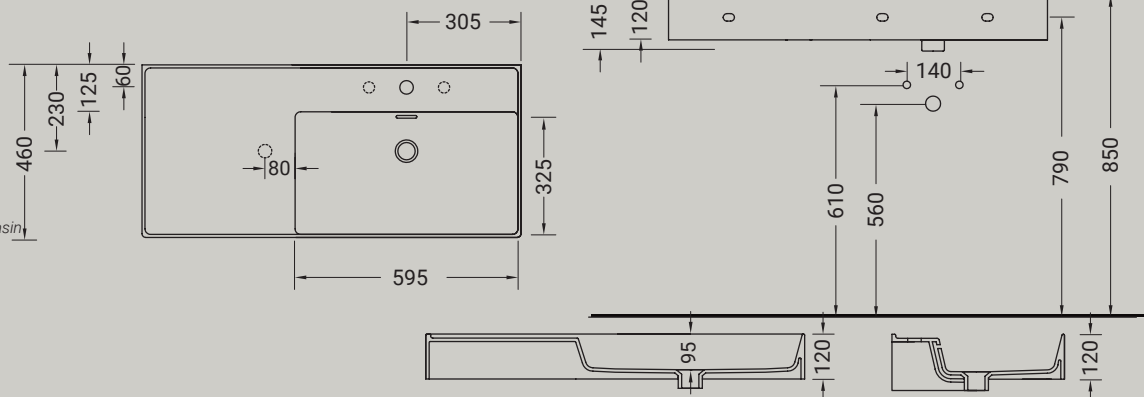

**ARTICOLO KI100SX** — 26,0 kg | 12 pz pallet Italia | 22 pz pallet Export

euro

**BIANCO LUCIDO**

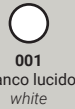

400

**COLORI DISPONIBILI**

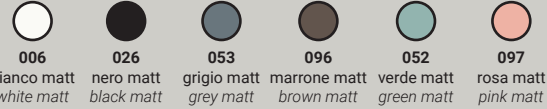

600

**TEXTURE DISPONIBILI**



650

**KIUB**

lavabo appoggio/sospeso monoforo su richiesta 2 o 3 fori  
*countertop/wall-hung washbasin 1th (on demand 2th or 3th)*



Accessori disponibili non inclusi/ *Available accessories not included*  
 art.P22 - P82 - P85 - P125

**FISSAGGIO**  
 P85 - sistema fissaggio per lavabi appoggio Euro 10,00  
 P22 - sistema fissaggio per lavabi sospesi per muro portante Euro 10,00

*P22 - fixing kit for wal-hung washbasin for load-bearing wall Euro 10,00*  
*P85 - fixing kit for countertop washbasin Euro 10,00*

**PILETTA**  
 P125 - piletta click-clack o flusso continuo per lavabo con copertura in ceramica Euro 72,00  
*P125 - click-clack drain or open outlet drain for washbasin with ceramic cover Euro 72,00*

**SIFONE**  
 P82 - sifone CROMO per lavabo Euro 90,00  
*P82 - CHROMED trap for washbasin Euro 90,00*

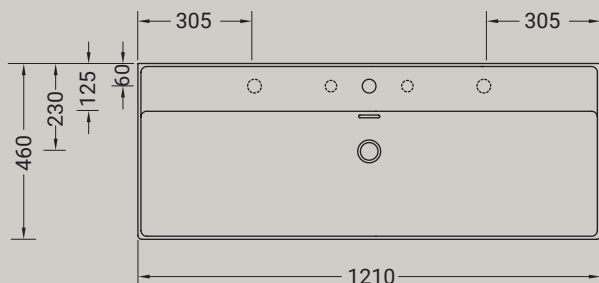

**ARTICOLO KI120** — 30,5 kg | 10 pz pallet Italia | 15 pz pallet Export

euro

**BIANCO LUCIDO**

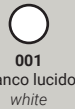

460

**COLORI DISPONIBILI**



690

**TEXTURE DISPONIBILI**



750



## KIUB

lavabo appoggio/sospeso con doppia vasca monoforo su richiesta 3 fori  
*countertop/wall-hung washbasin with double bowl 1th (on demand 3 th)*



ARTICOLO KI120DV — 29,5 kg   10 pz pallet Italia   15 pz pallet Export		euro
<b>BIANCO LUCIDO</b>	<b>001</b> bianco lucido white	480
<b>COLORI DISPONIBILI</b>	<b>006</b> bianco matt white matt <b>026</b> nero matt black matt <b>053</b> grigio matt grey matt <b>096</b> marrone matt brown matt <b>052</b> verde matt green matt <b>097</b> rosa matt pink matt	720
<b>TEXTURE DISPONIBILI</b>	<b>100</b> ceppo di gré grey <b>101</b> white matt marble <b>103</b> green alpes green alpes <b>104</b> black gold marble	780

Accessori disponibili non inclusi/  
*Available accessories not included*  
 art.P22 - P82 - P85 - P125

### FISSAGGIO

P85 - sistema fissaggio per lavabi appoggio Euro 10,00  
 P22 - sistema fissaggio per lavabi sospesi per muro portante Euro 10,00

*P22 - fixing kit for wall-hung washbasin for load-bearing wall Euro 10,00*  
*P85 - fixing kit for countertop washbasin Euro 10,00*

### PILETTA

P125 - piletta click-clack o flusso continuo per lavabo con copertura in ceramica Euro 72,00  
*P125 - click-clack drain or open outlet drain for washbasin with ceramic cover Euro 72,00*

### SIFONE

P82 - sifone CROMO per lavabo Euro 90,00  
*P82 - CHROMED trap for washbasin Euro 90,00*

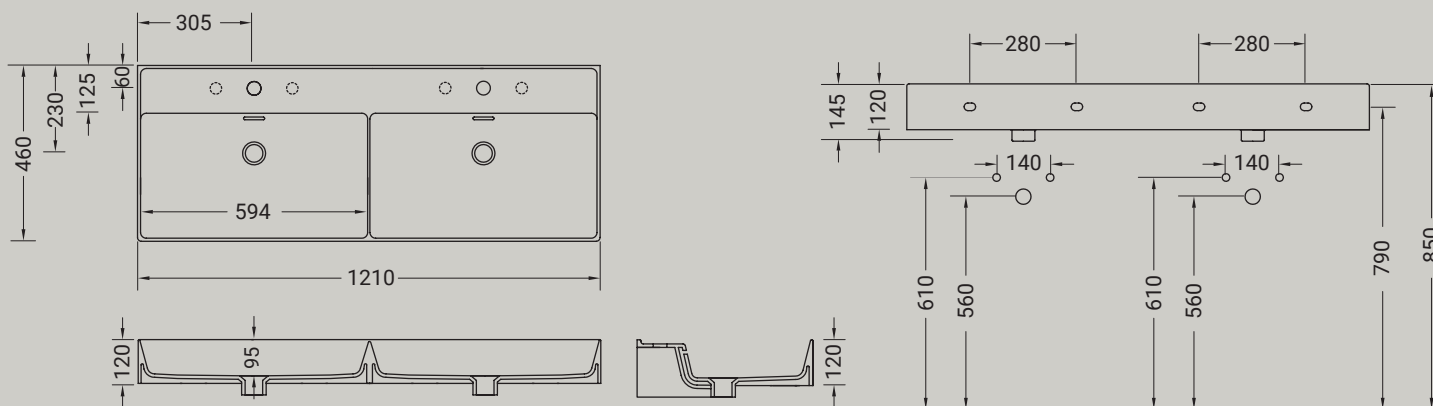

## PILETTA





piletta click-clack per lavabo con copertura in ceramica  
*click-clack drain for washbasin with ceramic cover*

ARTICOLO P125 — 0,4kg		euro
<b>COLORI DISPONIBILI</b>	<b>001</b> bianco lucido white shine <b>006</b> bianco matt white matt <b>026</b> nero matt black matt <b>053</b> grigio matt grey matt <b>096</b> marrone matt brown matt <b>052</b> verde matt green matt <b>097</b> rosa matt pink matt	72
<b>TEXTURE DISPONIBILI</b>	<b>100</b> ceppo di gré grey <b>101</b> white matt marble <b>103</b> green alpes green alpes <b>104</b> black gold marble	72

**KIUB**

struttura 60 - composizione 1 cassetto  
structure 60 + drawer







<b>ARTICOLO KSC60 – LAVABO ESCLUSO / WASHBASIN NOT INCLUDED</b>		euro
<b>ARTICOLO KSC60-S* – LAVABO ESCLUSO / WASHBASIN NOT INCLUDED</b>		
FINITURE DISPONIBILI	 <b>110</b> rovere rustico rustic oak	1070
	 <b>111</b> abete scuro spruce	
	 <b>112</b> cemento scuro concrete	
LEGNO LACCATO	 <b>026</b> nero matt black matt lacquered wood	1200

**KIUB**

struttura 60 composizione piani  
structure 60 + shelves



<b>ARTICOLO KSP60 – LAVABO ESCLUSO / WASHBASIN NOT INCLUDED</b>		euro
<b>ARTICOLO KSP60-S* – LAVABO ESCLUSO / WASHBASIN NOT INCLUDED</b>		
FINITURE DISPONIBILI	 <b>110</b> rovere rustico rustic oak	670
	 <b>111</b> abete scuro spruce	
	 <b>112</b> cemento scuro concrete	
LEGNO LACCATO	 <b>026</b> nero matt black matt lacquered wood	750

**KIUB**

struttura 50 o 60 composizione con griglia  
structure 50 or 60 + grate shelf







<b>ARTICOLO KSG60 – LAVABO ESCLUSO / WASHBASIN NOT INCLUDED</b>		euro
<b>ARTICOLO KSG60-S* – LAVABO ESCLUSO / WASHBASIN NOT INCLUDED</b>		
		780
<b>ARTICOLO KSG50 – LAVABO ESCLUSO / WASHBASIN NOT INCLUDED</b>		euro
<b>ARTICOLO KSG50-S* – LAVABO ESCLUSO / WASHBASIN NOT INCLUDED</b>		
		740

**KIUB**

struttura 80 - composizione 1 cassetto  
+ piano  
structure 80 + drawer + shelf



<b>ARTICOLO KSCP80 – LAVABO ESCLUSO / WASHBASIN NOT INCLUDED</b>		euro
<b>ARTICOLO KSCP80-S* – LAVABO ESCLUSO / WASHBASIN NOT INCLUDED</b>		
FINITURE DISPONIBILI	 <b>110</b> rovere rustico rustic oak	1100
	 <b>111</b> abete scuro spruce	
	 <b>112</b> cemento scuro concrete	
LEGNO LACCATO	 <b>026</b> nero matt black matt lacquered wood	1250

\*Struttura sospesa/Wall-hung structure

**KIUB**

struttura 80 - composizione 1 cassetto  
+ griglia  
structure 80 + drawer + grate shelf



**KIUB**

struttura 80 - composizione con piani  
structure 80 + shelves



**KIUB**





struttura 100 composizione 1 cassetto  
+ piano  
structure 100 + drawer + shelf











**KIUB**





struttura 100 composizione 1 cassetto  
+ griglia  
structure 100 + drawer + grate shelf



<b>ARTICOLO KSCG80</b> – LAVABO ESCLUSO / WASHBASIN NOT INCLUDED	euro
<b>ARTICOLO KSCG80-S*</b> – LAVABO ESCLUSO / WASHBASIN NOT INCLUDED	
FINITURE DISPONIBILI	1200
<div style="display: flex; justify-content: space-around;"> <div style="text-align: center;">   <b>110</b>                      rovere rustico  <i>rustic oak</i> </div> <div style="text-align: center;">   <b>111</b>                      abete scuro  <i>spruce</i> </div> <div style="text-align: center;">   <b>112</b>                      cemento scuro  <i>concrete</i> </div> </div>	
LEGNO LACCATO	1330
<div style="text-align: center;">   <b>026</b>                      nero matt  <i>black matt</i>                      lacquered wood                 </div>	

<b>ARTICOLO KSP80</b> – LAVABO ESCLUSO / WASHBASIN NOT INCLUDED	euro
<b>ARTICOLO KSP80-S*</b> – LAVABO ESCLUSO / WASHBASIN NOT INCLUDED	
FINITURE DISPONIBILI	720
<div style="display: flex; justify-content: space-around;"> <div style="text-align: center;">   <b>110</b>                      rovere rustico  <i>rustic oak</i> </div> <div style="text-align: center;">   <b>111</b>                      abete scuro  <i>spruce</i> </div> <div style="text-align: center;">   <b>112</b>                      cemento scuro  <i>concrete</i> </div> </div>	
LEGNO LACCATO	820
<div style="text-align: center;">   <b>026</b>                      nero matt  <i>black matt</i>                      lacquered wood                 </div>	

<b>ARTICOLO KSCP100</b> – LAVABO ESCLUSO / WASHBASIN NOT INCLUDED	euro
<b>ARTICOLO KSCP100-S*</b> – LAVABO ESCLUSO / WASHBASIN NOT INCLUDED	
FINITURE DISPONIBILI	1170
<div style="display: flex; justify-content: space-around;"> <div style="text-align: center;">   <b>110</b>                      rovere rustico  <i>rustic oak</i> </div> <div style="text-align: center;">   <b>111</b>                      abete scuro  <i>spruce</i> </div> <div style="text-align: center;">   <b>112</b>                      cemento scuro  <i>concrete</i> </div> </div>	
LEGNO LACCATO	1350
<div style="text-align: center;">   <b>026</b>                      nero matt  <i>black matt</i>                      lacquered wood                 </div>	

<b>ARTICOLO KSCG100</b> – LAVABO ESCLUSO / WASHBASIN NOT INCLUDED	euro
<b>ARTICOLO KSCG100-S*</b> – LAVABO ESCLUSO / WASHBASIN NOT INCLUDED	
FINITURE DISPONIBILI	1250
<div style="display: flex; justify-content: space-around;"> <div style="text-align: center;">   <b>110</b>                      rovere rustico  <i>rustic oak</i> </div> <div style="text-align: center;">   <b>111</b>                      abete scuro  <i>spruce</i> </div> <div style="text-align: center;">   <b>112</b>                      cemento scuro  <i>concrete</i> </div> </div>	
LEGNO LACCATO	1380
<div style="text-align: center;">   <b>026</b>                      nero matt  <i>black matt</i>                      lacquered wood                 </div>	

\*Struttura sospesa/Wall-hung structure





**KIUB**

struttura 100 composizione con piani  
structure 100 + shelves



**ARTICOLO KSP100 - LAVABO ESCLUSO / WASHBASIN NOT INCLUDED** euro  
**ARTICOLO KSP100-S\* - LAVABO ESCLUSO / WASHBASIN NOT INCLUDED**

FINITURE DISPONIBILI				780
	110 rovere rustico rustic oak	111 abete scuro spruce	112 cemento scuro concrete	



LEGNO LACCATO		910
	026 nero matt black matt lacquered wood	

**KIUB**

struttura 120 composizione 2 cassetti  
structure 120 + two drawers



**ARTICOLO KS2C120 - LAVABO ESCLUSO / WASHBASIN NOT INCLUDED** euro  
**ARTICOLO KS2C120-S\* - LAVABO ESCLUSO / WASHBASIN NOT INCLUDED**

FINITURE DISPONIBILI				1650
	110 rovere rustico rustic oak	111 abete scuro spruce	112 cemento scuro concrete	



LEGNO LACCATO		1900
	026 nero matt black matt lacquered wood	

**KIUB**

struttura 120 composizione 1 cassetto  
+ piani  
structure 120 + drawer + shelves



**ARTICOLO KSCP120 - LAVABO ESCLUSO / WASHBASIN NOT INCLUDED** euro  
**ARTICOLO KSCP120-S\* - LAVABO ESCLUSO / WASHBASIN NOT INCLUDED**

FINITURE DISPONIBILI				1250
	110 rovere rustico rustic oak	111 abete scuro spruce	112 cemento scuro concrete	



LEGNO LACCATO		1450
	026 nero matt black matt lacquered wood	

**KIUB**

struttura 120 composizione cassetto  
+ griglia  
structure 120 + drawers + grate shelf



**ARTICOLO KSCG120 - LAVABO ESCLUSO / WASHBASIN NOT INCLUDED** euro  
**ARTICOLO KSCG120-S\* - LAVABO ESCLUSO / WASHBASIN NOT INCLUDED**

FINITURE DISPONIBILI				1300
	110 rovere rustico rustic oak	111 abete scuro spruce	112 cemento scuro concrete	

LEGNO LACCATO		1430
	026 nero matt black matt lacquered wood	

\*Struttura sospesa/Wall-hung structure

**KIUB**

vasca in acrilico bianca lucida  
bathtub in acrylic white shine



**ARTICOLO KV60** — 68 kg

euro

BIANCO  
LUCIDO



2300

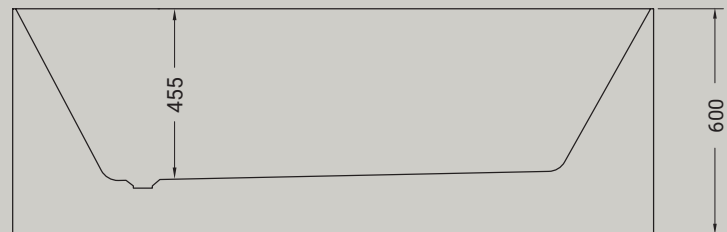
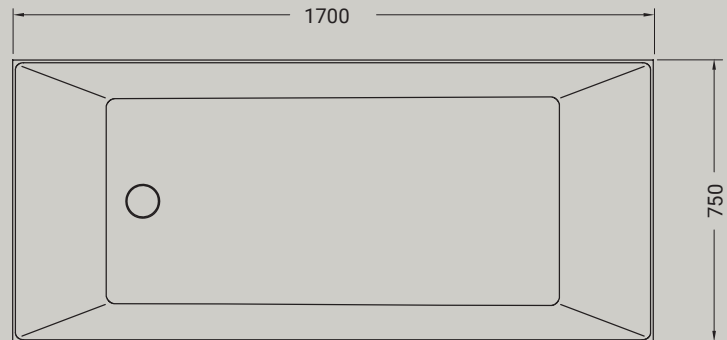

**KIUB**

vasca in solid surface bianca  
lucida e opaca  
bathtub in solid surface white shine  
and matt



**ARTICOLO KV61** — 170 kg

euro

ARTICOLO  
KV61L



3700

ARTICOLO  
KV61O



3700

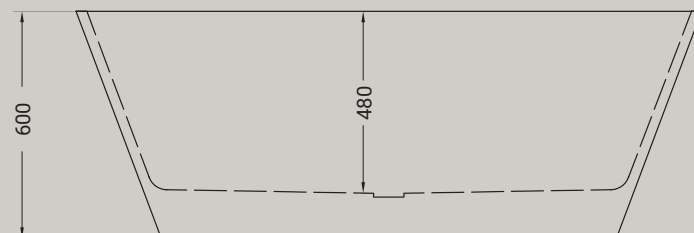
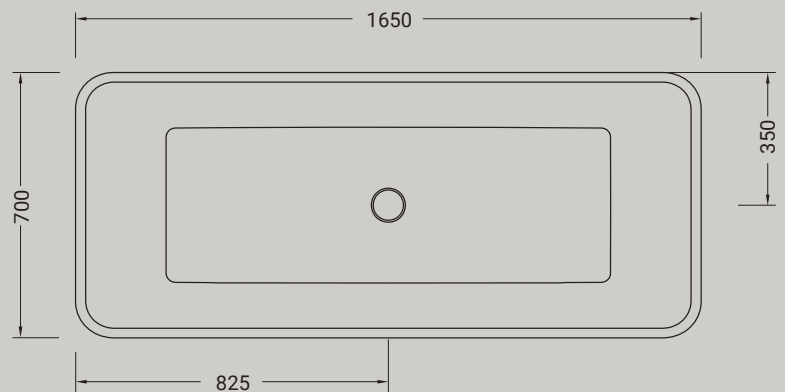

**KIUB**

asta laterale porta asciugamano cm 44  
wash basin towel holder lateral side cm 44



**ARTICOLO KIP44 - LAVABO ESCLUSO / WASHBASIN NOT INCLUDED**

euro

95

**KIUB**

asta frontale porta asciugamano cm 59  
towel holder front side cm 59 for wash  
basin K160/K1100DX/K1100SX/K1120/  
K1120DV



**ARTICOLO KIP59 - LAVABO ESCLUSO / WASHBASIN NOT INCLUDED**

euro

120



# GIÒ EVOLUTION

# GIÒ EVOLUTION

## WC

### GR20

37X55 cm



### GWR20

37X55 cm



## BIDET

### G24

37X55 cm



### GWR24

37X55 cm



## LAVABI

### G140

60X37 cm



### G143

43X37 cm



### G180

80X37 cm



### G15E

60X49 cm



### G17E

80X49 cm



### G240

60X40 cm



### G243

40X40 cm



### G280

80X40 cm



### G40E

60X40 cm



### G42E

Ø 42



### G43E

40X40 cm



### G60E

60X40 cm







HIDRA

design Meneghello Paoletti Associati



# GIÒ EVOLUTION

MADE IN ITALY

**Giò è una collezione concreta, pragmatica che si collega al meglio all'interno di tutte le tipologie di stanza da bagno grazie alla sua eleganza e sobrietà. La collezione è caratterizzata da un corretto e non banale utilizzo di curve e linee rette, quindi ad un ottimo bilanciamento di morbidezza e rotondità.**

*Giò is a concrete collection, thanks to its pragmatic and elegant simplicity it is connected to all types of bathroom. The collection is characterized by a proper and non-trivial use of curves and straight lines, so to a good balance of softness and roundness.*











HIDRA — GIÒ EVOLUTION





HIDRA — GIÒ EVOLUTION











006  
BIANCO MATT  
*white matt*



026  
NERO MATT  
*black matt*



053  
GRIGIO MATT  
*grey matt*



096  
MARRONE MATT  
*brown matt*



052  
VERDE MATT  
*green matt*



097  
ROSA MATT  
*pink matt*



006  
BIANCO MATT  
*white matt*



026  
NERO MATT  
*black matt*



053  
GRIGIO MATT  
*grey matt*



096  
MARRONE MATT  
*brown matt*



052  
VERDE MATT  
*green matt*



097  
ROSA MATT  
*pink matt*



## GIÒ EVOLUTION DECORATI



---

Giò Evolution si può scegliere anche la versione decorata: bianco/oro, nero/oro, bianco/platino, bianco/oro rosa, bianco/nero.  
*Giò Evolution you can also choose the decorated version: white / gold, black / gold, white / platinum, white / rose gold, white/black.*







HIDRA

GIÒ EVOLUTION







100  
CEPPO DI GRÈ  
*grey*



101  
white matt  
*marble*



103  
GREEN ALPES  
*marble*



104  
BLACK GOLD  
*marble*



009  
NERO LUCIDO  
*black shine*



013  
BIANCO/ORO  
*white/gold*



014  
BIANCO/PLATINO  
*white/platinum*



063  
BIANCO/ORO ROSA  
*white/rose gold*



020  
NERO/ORO  
*black/gold*



**GIÒ EVOLUTION**

vaso sospeso senza brida + kit di fissaggio  
wall-hung rimless WC + fixing kit



**ARTICOLO GWR20** — 24 kg | 12 pz pallet Italia | 20 pz pallet Export

euro

BIANCO  
LUCIDO



001  
bianco lucido  
white

300

COLORI  
DISPONIBILI



006  
bianco matt  
white matt



026  
nero matt  
black matt



053  
grigio matt  
grey matt



096  
marrone matt  
brown matt



052  
verde matt  
green matt



097  
rosa matt  
pink matt

450

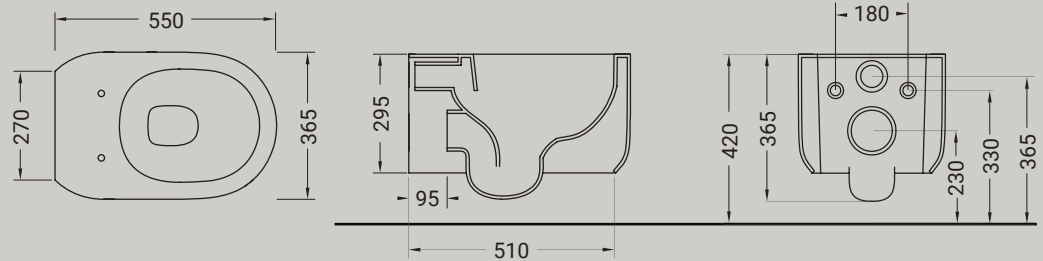

**GIÒ EVOLUTION**

bidet sospeso + kit fissaggio  
wall-hung bidet + fixing kit



**ARTICOLO GWR24** — 23,5 kg | 12 pz pallet Italia | 20 pz pallet Export

euro

BIANCO  
LUCIDO



001  
bianco lucido  
white

300

COLORI  
DISPONIBILI



006  
bianco matt  
white matt



026  
nero matt  
black matt



053  
grigio matt  
grey matt



096  
marrone matt  
brown matt



052  
verde matt  
green matt



097  
rosa matt  
pink matt

450

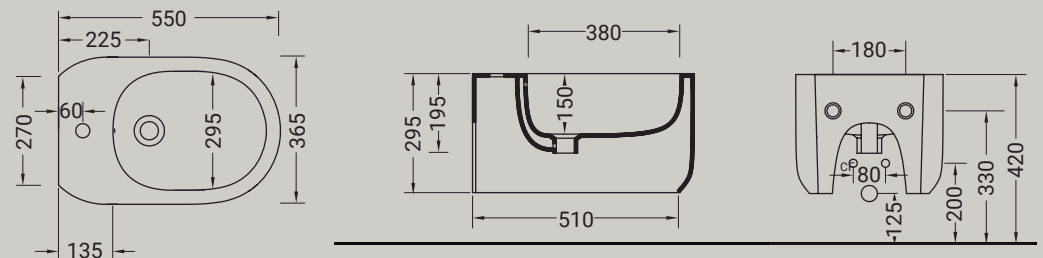

Accessori disponibili non inclusi/  
Available accessories not included  
art.P91

SIFONE  
P91 - sifone ribassato per bidet Euro 80,00  
P91 - CHROMED trap for washbasin Euro 80,00

## GIÒ EVOLUTION

vaso a terra senza brida traslato filo parete + kit fissaggio ghost  
wc rimless adjustable flush back to wall + ghost fixing



Accessori disponibili non inclusi/  
Available accessories not included  
art.P57 - P59 - P60 -P61 - P81

### A\*

#### CURVE SCARICO PAVIMENTO

curva P59 - scarico regolabile da 60 a 110 Euro 30,00  
curva P57 - scarico regolabile da 120 a 150 Euro 25,00  
curva P60 - scarico regolabile da 160 a 200 Euro 30,00

#### VERTICAL OUTLET PLASTIC PIPE

vertical outlet P59 - adjustable 60-110 Euro 30,00  
vertical outlet P57 - adjustable 120-150 Euro 25,00  
vertical outlet P60 - adjustable 160-200 Euro 30,00

### B\*\*

#### RACCORDO CARICO ACQUA / PIPE INLET WATER

P61 - regolabile 325 o 365 Euro 25,00  
P61 - adjustable 325 or 365 Euro 25,00

#### RACCORDO

P81 - raccordo di scarico parete Euro 25,00  
P81 - horizontal outlet plastic pipe Euro 25,00

<b>ARTICOLO GR20</b> - 26 kg   10 pz pallet Italia   20 pz pallet Export		euro
<b>BIANCO LUCIDO</b>	<b>001</b> bianco lucido white	300
<b>COLORI DISPONIBILI</b>	<b>006</b> bianco matt / white matt <b>026</b> nero matt / black matt <b>053</b> grigio matt / grey matt <b>096</b> marrone matt / brown matt <b>052</b> verde matt / green matt <b>097</b> rosa matt / pink matt	450

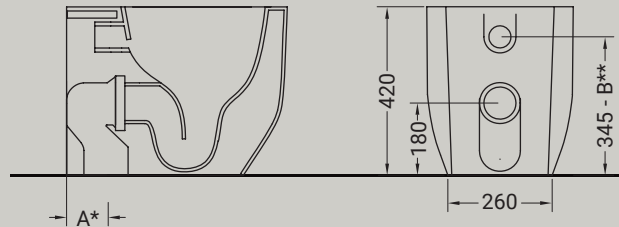
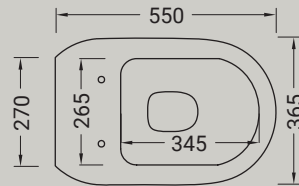

## GIÒ EVOLUTION

bidet filomuro + kit fissaggio ghost  
bidet back to wall + ghost fixing



<b>ARTICOLO G24</b> - 24 kg   10 pz pallet Italia   20 pz pallet Export		euro
<b>BIANCO LUCIDO</b>	<b>001</b> bianco lucido white	300
<b>COLORI DISPONIBILI</b>	<b>006</b> bianco matt / white matt <b>026</b> nero matt / black matt <b>053</b> grigio matt / grey matt <b>096</b> marrone matt / brown matt <b>052</b> verde matt / green matt <b>097</b> rosa matt / pink matt	450

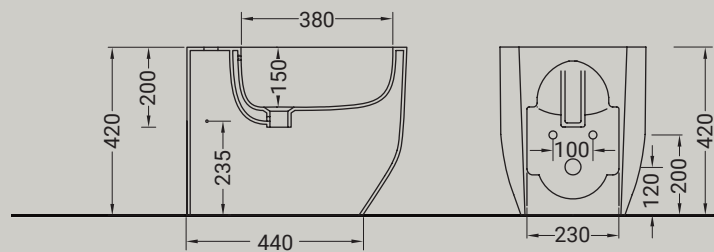
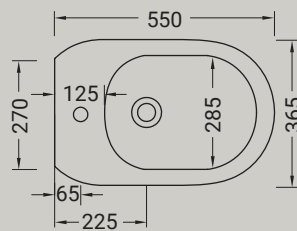

## GIÒ EVOLUTION

copri vaso slim soft-close sgancio rapido  
quick release soft-close Slim seat



<b>ARTICOLO GZQ</b> - 3 kg		euro
<b>BIANCO LUCIDO</b>	<b>001</b> bianco lucido white	150
<b>COLORI DISPONIBILI</b>	<b>006</b> bianco matt / white matt <b>026</b> nero matt / black matt <b>053</b> grigio matt / grey matt <b>096</b> marrone matt / brown matt <b>052</b> verde matt / green matt <b>097</b> rosa matt / pink matt	225

**GIÒ EVOLUTION**

lavabo rettangolare appoggio  
rectangular countertop washbasin



Accessori disponibili non inclusi/  
Available accessories not included  
art.P85 - P90- P125

















**FISSAGGIO**  
P85 - sistema fissaggio per lavabi appoggio Euro 10,00  
P85 - fixing kit for countertop washbasin Euro 10,00

**PILETTA**  
P90 - piletta flusso continuo per lavabo Euro 72,00  
P125 - piletta click-clack o flusso continuo per  
lavabo con copertura in ceramica Euro 72,00

P90 - open outlet drain for washbasin Euro 72,00  
P125 - click-clack drain or open outlet drain for washbasin  
with ceramic cover Euro 72,00

**ARTICOLO G40E** — 13 kg | 20 pz pallet Italia | 42 pz pallet Export

euro

<b>BIANCO LUCIDO</b>		<b>001</b> bianco lucido white								250
<b>COLORI DISPONIBILI</b>										375
<b>DECORI DISPONIBILI</b>										620
<b>DECORO NERO/ORO</b>										730
<b>TEXTURE DISPONIBILI</b>										500

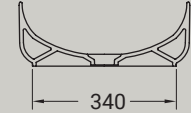
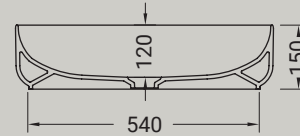
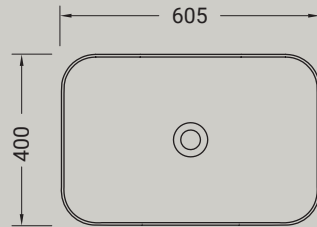

**GIÒ EVOLUTION**

lavabo tondo appoggio  
round countertop washbasin



Accessori disponibili non inclusi/  
Available accessories not included  
art.P85 - P90- P125

















**FISSAGGIO**  
P85 - sistema fissaggio per lavabi appoggio Euro 10,00  
P85 - fixing kit for countertop washbasin Euro 10,00

**PILETTA**  
P90 - piletta flusso continuo per lavabo Euro 72,00  
P125 - piletta click-clack o flusso continuo per  
lavabo con copertura in ceramica Euro 72,00

P90 - open outlet drain for washbasin Euro 72,00  
P125 - click-clack drain or open outlet drain for washbasin  
with ceramic cover Euro 72,00

**ARTICOLO G42E** — 7,5 kg | 34 pz pallet Italia | 60 pz pallet Export

euro

<b>BIANCO LUCIDO</b>		<b>001</b> bianco lucido white								220
<b>COLORI DISPONIBILI</b>										330
<b>DECORI DISPONIBILI</b>										550
<b>DECORO NERO/ORO</b>										660
<b>TEXTURE DISPONIBILI</b>										480

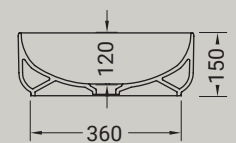
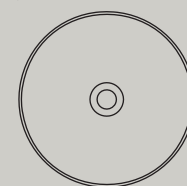
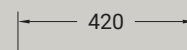



**GIÒ EVOLUTION**

lavabo ovale appoggio  
oval countertop washbasin



Accessori disponibili non inclusi/  
Available accessories not included  
art.P85 - P90- P125

**FISSAGGIO**  
P85 - sistema fissaggio per lavabi appoggio Euro 10,00  
P85 - fixing kit for countertop washbasin Euro 10,00

**PILETTA**  
P90 - piletta flusso continuo per lavabo Euro 72,00  
P125 - piletta click-clack o flusso continuo per  
lavabo con copertura in ceramica Euro 72,00

P90 - open outlet drain for washbasin Euro 72,00  
P125 - click-clack drain or open outlet drain for washbasin  
with ceramic cover Euro 72,00

ARTICOLO G60E — 14 kg   20 pz pallet Italia   42 pz pallet Export		euro
BIANCO LUCIDO	001 bianco lucido white	250
COLORI DISPONIBILI	006 bianco matt white matt 026 nero matt black matt 009 nero lucido black shine 053 grigio matt grey matt 096 marrone matt brown matt 052 verde matt green matt 097 rosa matt pink matt	375
DECORI DISPONIBILI	013 bianco/oro white/gold 014 bianco/platino white/platinum 063 bianco/oro rosa white/rose gold	620
DECORO NERO/ORO	020 nero/oro black/gold	730
TEXTURE DISPONIBILI	100 ceppo di gré grey 101 white matt marble 103 green alpes green alpes 104 black gold marble	500

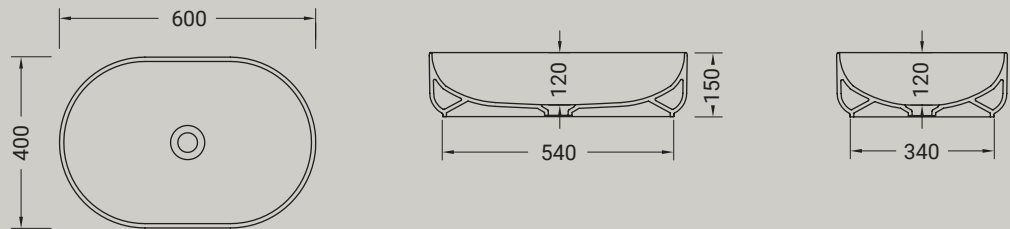

**GIÒ EVOLUTION**

lavabo quadro appoggio  
squared countertop washbasin



Accessori disponibili non inclusi/  
Available accessories not included  
art.P85 - P90- P125

**FISSAGGIO**  
P85 - sistema fissaggio per lavabi appoggio Euro 10,00  
P85 - fixing kit for countertop washbasin Euro 10,00

**PILETTA**  
P90 - piletta flusso continuo per lavabo Euro 72,00  
P125 - piletta click-clack o flusso continuo per  
lavabo con copertura in ceramica Euro 72,00

P90 - open outlet drain for washbasin Euro 72,00  
P125 - click-clack drain or open outlet drain for washbasin  
with ceramic cover Euro 72,00

ARTICOLO G43E — 9,5 kg   34 pz pallet Italia   60 pz pallet Export		euro
BIANCO LUCIDO	001 bianco lucido white	220
COLORI DISPONIBILI	006 bianco matt white matt 026 nero matt black matt 009 nero lucido black shine 053 grigio matt grey matt 096 marrone matt brown matt 052 verde matt green matt 097 rosa matt pink matt	330
DECORI DISPONIBILI	013 bianco/oro white/gold 014 bianco/platino white/platinum 063 bianco/oro rosa white/rose gold	550
DECORO NERO/ORO	020 nero/oro black/gold	660
TEXTURE DISPONIBILI	100 ceppo di gré grey 101 white matt marble 103 green alpes green alpes 104 black gold marble	480

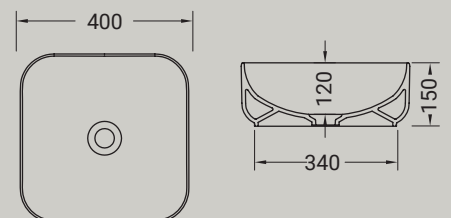

## GIÒ EVOLUTION

lavabo sospeso/appoggio monoforo  
su richiesta 3 fori  
wash basin wall hung/countertop 1th  
3 th on demand



Accessori disponibili non inclusi/  
Available accessories not included  
art.P22 - P82 - P85 - P125

### FISSAGGIO

P85 - sistema fissaggio per lavabi appoggio Euro 10,00  
P22 - sistema fissaggio per lavabi sospesi  
per muro portante Euro 10,00

P85 - fixing kit for countertop washbasin Euro 10,00  
P22 - fixing kit for wall-hung washbasin for  
load-bearing wall Euro 10,00

### PILETTA

P90 - piletta flusso continuo per lavabo Euro 72,00  
P125 - piletta click-clack o flusso continuo per  
lavabo con copertura in ceramica Euro 72,00

P90 - open outlet drain for washbasin Euro 72,00  
P125 - click-clack drain or open outlet drain for  
washbasin with ceramic cover Euro 72,00

ARTICOLO G15E — 14 kg | 20 pz pallet Italia | 34 pz pallet Export

euro

BIANCO  
LUCIDO



001  
bianco lucido  
white

250

COLORI  
DISPONIBILI



006  
bianco matt  
white matt



026  
nero matt  
black matt



053  
grigio matt  
grey matt



096  
marrone matt  
brown matt



052  
verde matt  
green matt



097  
rosa matt  
pink matt

375

lato non smaltato/unglazed side

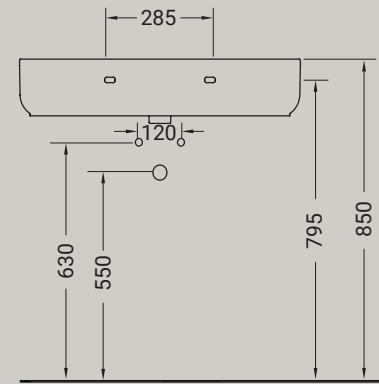
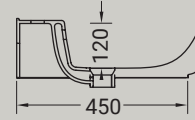
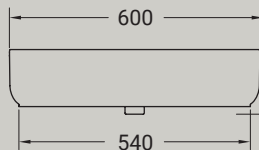
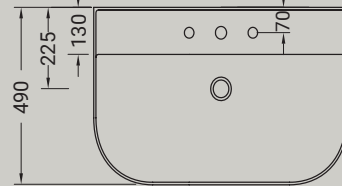

## GIÒ EVOLUTION

lavabo sospeso/appoggio monoforo  
su richiesta 3 fori  
wash basin wall hung/countertop 1th  
3 th on demand



Accessori disponibili non inclusi/  
Available accessories not included  
art.P22 - P82 - P85 - P125

### FISSAGGIO

P85 - sistema fissaggio per lavabi appoggio Euro 10,00  
P22 - sistema fissaggio per lavabi sospesi  
per muro portante Euro 10,00

P85 - fixing kit for countertop washbasin Euro 10,00  
P22 - fixing kit for wall-hung washbasin for  
load-bearing wall Euro 10,00

### PILETTA

P90 - piletta flusso continuo per lavabo Euro 72,00  
P125 - piletta click-clack o flusso continuo per  
lavabo con copertura in ceramica Euro 72,00

P90 - open outlet drain for washbasin Euro 72,00  
P125 - click-clack drain or open outlet drain for  
washbasin with ceramic cover Euro 72,00

ARTICOLO G17E — 21 kg | 15 pz pallet Italia | 25 pz pallet Export

euro

BIANCO  
LUCIDO



001  
bianco lucido  
white

270

COLORI  
DISPONIBILI



006  
bianco matt  
white matt



026  
nero matt  
black matt



053  
grigio matt  
grey matt



096  
marrone matt  
brown matt



052  
verde matt  
green matt



097  
rosa matt  
pink matt

405



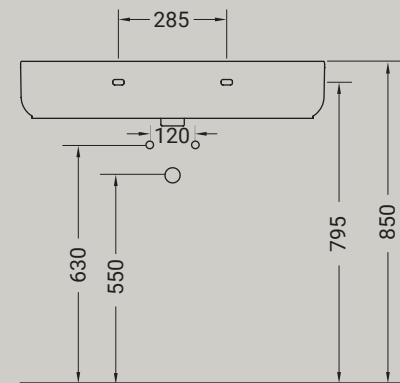
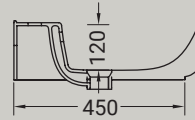
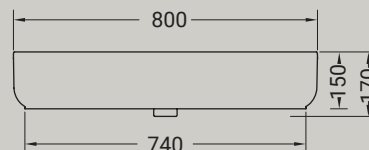
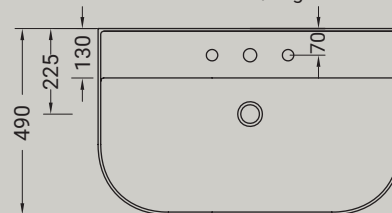



lato non smaltato/unglazed side



**GIÒ EVOLUTION**

lavabo incasso  
drop in washbasin





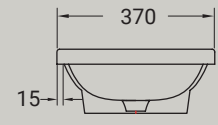
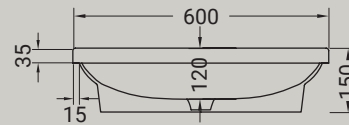
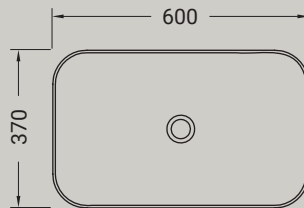



<b>ARTICOLO G140</b> — 11 kg   20 pz pallet Italia   42 pz pallet Export		euro
<b>BIANCO LUCIDO</b>	 001 bianco lucido white	250
<b>COLORI DISPONIBILI</b>	 006 bianco matt white matt  026 nero matt black matt  053 grigio matt grey matt  096 marrone matt brown matt  052 verde matt green matt  097 rosa matt pink matt	375
<b>DECORI DISPONIBILI</b>	 013 bianco/oro white/gold  014 bianco/platino white/platinum  063 bianco/oro rosa white/rose gold	480



**GIÒ EVOLUTION**

lavabo incasso  
drop in washbasin



<b>ARTICOLO G143</b> — 7 kg   24 pz pallet Italia   60 pz pallet Export		euro
<b>BIANCO LUCIDO</b>	 001 bianco lucido white	220
<b>COLORI DISPONIBILI</b>	 006 bianco matt white matt  026 nero matt black matt  053 grigio matt grey matt  096 marrone matt brown matt  052 verde matt green matt  097 rosa matt pink matt	330
<b>DECORI DISPONIBILI</b>	 013 bianco/oro white/gold  014 bianco/platino white/platinum  063 bianco/oro rosa white/rose gold	440

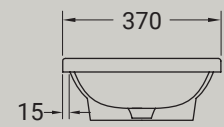
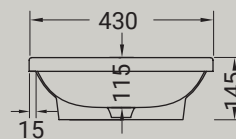
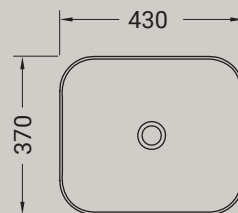



**GIÒ EVOLUTION**

lavabo incasso  
washbasin inset thin rim 80x37

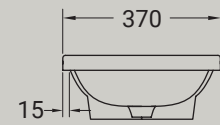
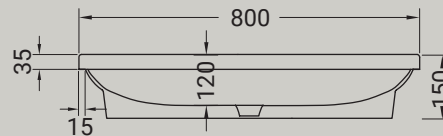
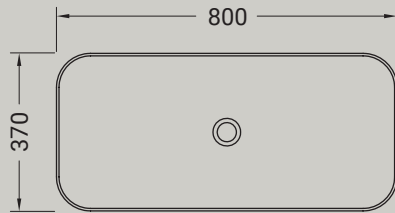



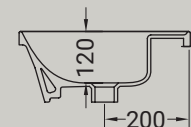
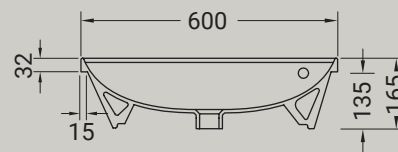
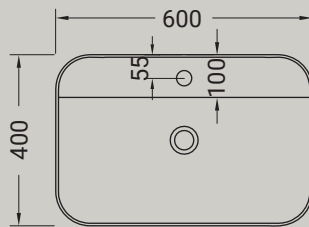

<b>ARTICOLO G180</b> — 15 kg   15 pz pallet Italia   30 pz pallet Export		euro
<b>BIANCO LUCIDO</b>	 <b>001</b> bianco lucido <i>white</i>	270
<b>COLORI DISPONIBILI</b>	 <b>006</b> bianco matt <i>white matt</i>  <b>026</b> nero matt <i>black matt</i>  <b>053</b> grigio matt <i>grey matt</i>  <b>096</b> marrone matt <i>brown matt</i>  <b>052</b> verde matt <i>green matt</i>  <b>097</b> rosa matt <i>pink matt</i>	405
<b>DECORI DISPONIBILI</b>	 <b>013</b> bianco/oro <i>white/gold</i>  <b>014</b> bianco/platino <i>white/platinum</i>  <b>063</b> bianco/oro rosa <i>white/rose gold</i>	540

**GIÒ EVOLUTION**

lavabo incasso monoforo  
drop in washbasin 1 hole



<b>ARTICOLO G240</b> — 13 kg   20 pz pallet Italia   42 pz pallet Export		euro
<b>BIANCO LUCIDO</b>	 <b>001</b> bianco lucido <i>white</i>	250
<b>COLORI DISPONIBILI</b>	 <b>006</b> bianco matt <i>white matt</i>  <b>026</b> nero matt <i>black matt</i>  <b>053</b> grigio matt <i>grey matt</i>  <b>096</b> marrone matt <i>brown matt</i>  <b>052</b> verde matt <i>green matt</i>  <b>097</b> rosa matt <i>pink matt</i>	375
<b>DECORI DISPONIBILI</b>	 <b>013</b> bianco/oro <i>white/gold</i>  <b>014</b> bianco/platino <i>white/platinum</i>  <b>063</b> bianco/oro rosa <i>white/rose gold</i>	480

**GIÒ EVOLUTION**

lavabo incasso monoforo  
drop in washbasin 1 hole



**ARTICOLO G243** — 9 kg | 34 pz pallet Italia | 60 pz pallet Export

euro

BIANCO  
LUCIDO



**001**  
bianco lucido  
white

220

COLORI  
DISPONIBILI



**006**  
bianco matt  
white matt



**026**  
nero matt  
black matt



**053**  
grigio matt  
grey matt



**096**  
marrone matt  
brown matt



**052**  
verde matt  
green matt



**097**  
rosa matt  
pink matt

330

DECORI  
DISPONIBILI



**013**  
bianco/oro  
white/gold



**014**  
bianco/platino  
white/platinum



**063**  
bianco/oro rosa  
white/rose gold

440

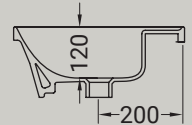
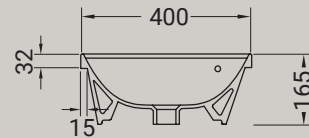
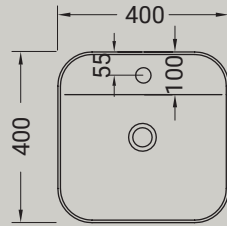

**GIÒ EVOLUTION**

lavabo incasso monoforo  
washbasin inset thin rim 80x401th



**ARTICOLO G280** — 17 kg | 14 pz pallet Italia | 30 pz pallet Export

euro

BIANCO  
LUCIDO



**001**  
bianco lucido  
white

270

COLORI  
DISPONIBILI



**006**  
bianco matt  
white matt



**026**  
nero matt  
black matt



**053**  
grigio matt  
grey matt



**096**  
marrone matt  
brown matt



**052**  
verde matt  
green matt



**097**  
rosa matt  
pink matt

405

DECORI  
DISPONIBILI



**013**  
bianco/oro  
white/gold



**014**  
bianco/platino  
white/platinum



**063**  
bianco/oro rosa  
white/rose gold

540

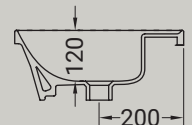
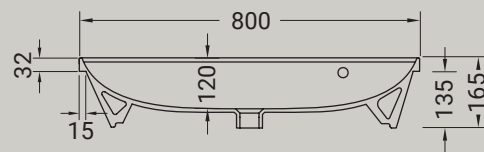
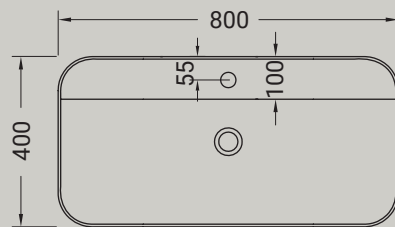

**PILETTA**

piletta click-clack per lavabo con copertura  
in ceramica  
click-clack drain for washbasin with ceramic  
cover

**ARTICOLO P125** — 0,4kg

euro

COLORI  
DISPONIBILI



**001**  
bianco lucido  
white shine



**006**  
bianco matt  
white matt



**026**  
nero matt  
black matt



**053**  
grigio matt  
grey matt



**096**  
marrone matt  
brown matt



**052**  
verde matt  
green matt



**097**  
rosa matt  
pink matt

72

TEXTURE  
DISPONIBILI



**100**  
ceppo di gré  
grey



**101**  
white matt  
marble



**103**  
green alpes  
green alpes



**104**  
black gold  
marble

72

**GIÒ EVOLUTION**

vasca in acrilico bianca lucida  
 bathtub in acrylic white shine

**ARTICOLO GV60** — 60 kg

euro

BIANCO  
 LUCIDO



006  
 bianco matt  
 white matt

2300

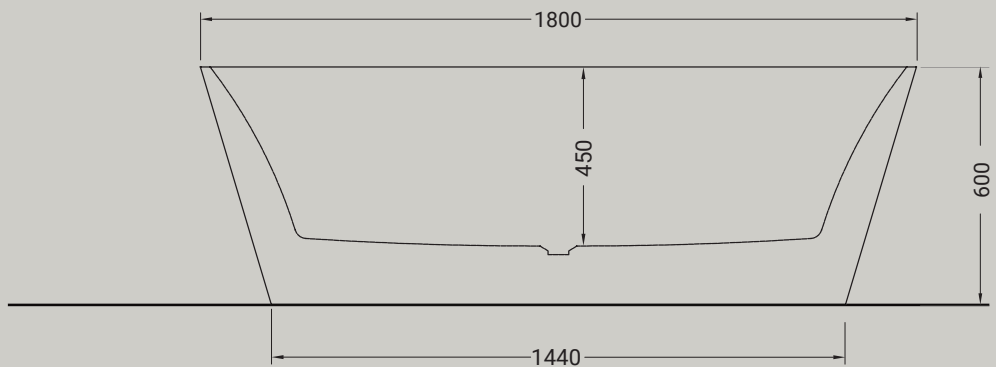
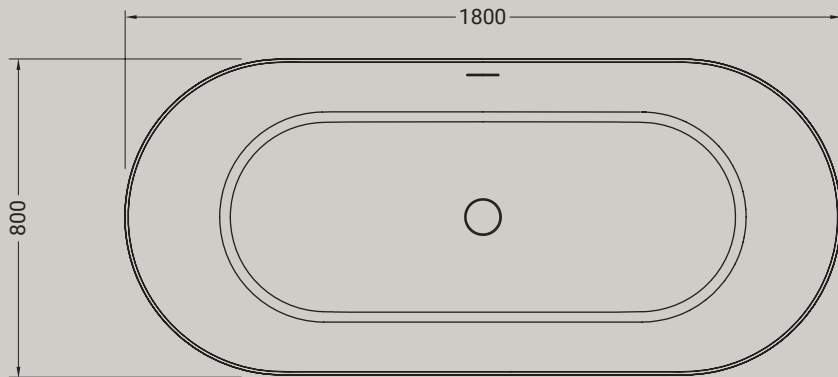





## GIÒ EVOLUTION

vasca in solid surface bianca  
 lucida e opaca  
*bathtub in solid surface white shine  
 and matt*



ARTICOLO GV61 - 150 kg		euro
ARTICOLO GV61L	 <b>001</b> bianco lucido white shine	4200
ARTICOLO GV61O	 <b>006</b> bianco matt white matt	4200

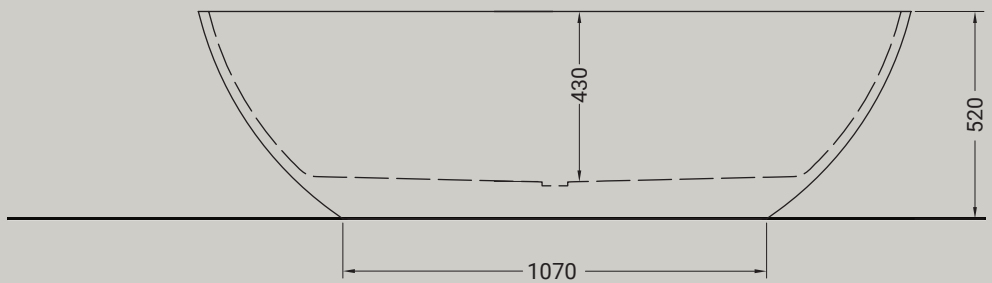
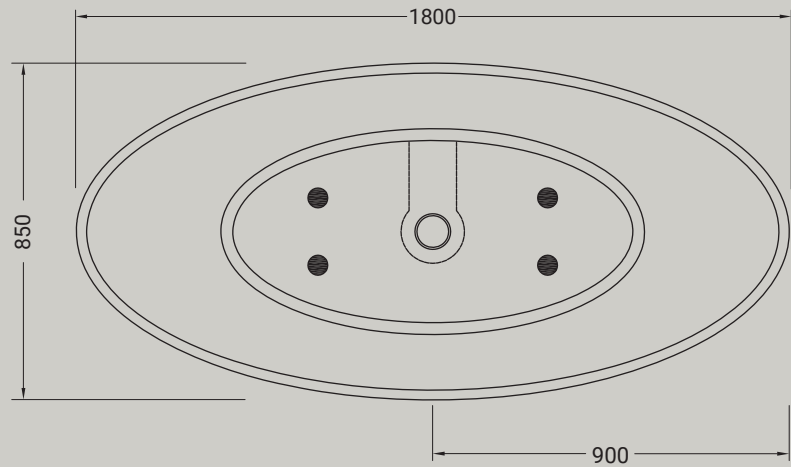

**TOUR**

# TOUR

## WC

### **TUR30**

35,5X52 cm



### **TUWR30**

35,5X52 cm



## BIDET

### **TU24I**

35,5X52 cm



### **TUW24I**

35,5X52 cm







HIDRA



# TOUR

MADE IN ITALY

**La Tour si propone come la base del design, una serie semplice e pulita, diretta e senza segreti, esce con un prezzo competitivo e un design moderno, la giusta combinazione per far fronte alle difficoltà del mercato attuale.**

*Tour is meant to be the base of design, a clean range of sanitaryware that goes straight to the point, without any secrets. Is simple both in the design and in the price, certainly the right combination to succeed in this difficult market period.*



















**TOUR**

vaso sospeso senza brida + kit fissaggio  
wc wall hung rimless + fixing kit



**ARTICOLO TUWR30** – 22 kg | 12 pz pallet Italia | 20 pz pallet Export

euro

BIANCO  
LUCIDO



001  
bianco lucido  
white

290

COLORI  
DISPONIBILI



006  
bianco matt  
white matt



026  
nero matt  
black matt



053  
grigio matt  
grey matt

430

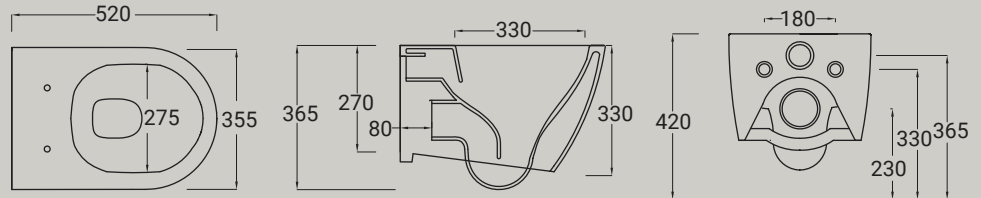

**TOUR**

bidet sospeso + kit fissaggio  
bidet wall hung + fixing kit



**ARTICOLO TUW241** – 20 kg | 12 pz pallet Italia | 20 pz pallet Export

euro

BIANCO  
LUCIDO



001  
bianco lucido  
white

290

COLORI  
DISPONIBILI



006  
bianco matt  
white matt



026  
nero matt  
black matt



053  
grigio matt  
grey matt

430

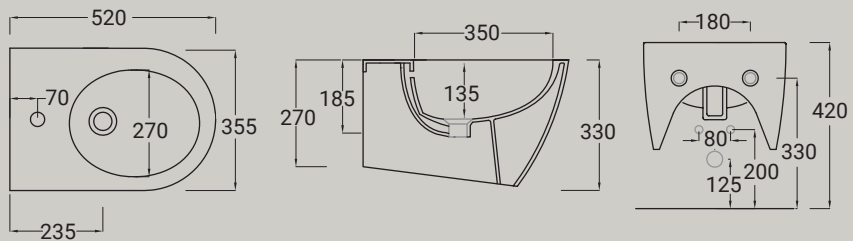

Accessori disponibili non inclusi/  
Available accessories not included  
art.P91

SIFONE  
P91 - sifone ribassato per bidet Euro 80,00  
P91 - CHROMED trap for washbasin Euro 80,00

**TOUR**

vaso senza brida traslato filo parete + kit fissaggio  
wc back to wall rimless adjusting flushing + fixing kit



**ARTICOLO TUR30** – 29 kg | 10 pz pallet Italia | 20 pz pallet Export

euro

BIANCO  
LUCIDO



001  
bianco lucido  
white

290

COLORI  
DISPONIBILI



006  
bianco matt  
white matt



026  
nero matt  
black matt



053  
grigio matt  
grey matt

430

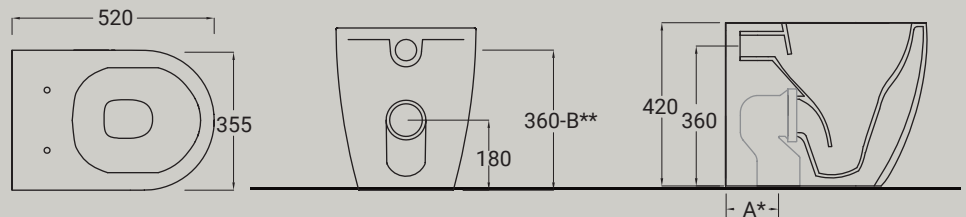

Accessori disponibili non inclusi/  
Available accessories not included  
art. P57 - P59 - P60 - P61 - P81

**A\***  
CURVE SCARICO PAVIMENTO  
curva P59 - scarico regolabile da 60 a 130 Euro 30,00  
curva P57 - scarico regolabile da 140 a 150 Euro 25,00  
curva P60 - scarico regolabile da 160 a 200 Euro 30,00

**VERTICAL OUTLET PLASTIC PIPE**  
vertical outlet P59 - adjustable 60-130 Euro 30,00  
vertical outlet P57 - adjustable 140-150 Euro 25,00  
vertical outlet P60 - adjustable 160-200 Euro 30,00

**B\*\***  
RACCORDO CARICO ACQUA / PIPE INLET WATER  
P61 - regolabile 340 o 380 Euro 25,00  
P61 - adjustable 340 or 380 Euro 25,00

**RACCORDO**  
P81 - raccordo di scarico parete Euro 25,00  
P81 - horizontal outlet plastic pipe Euro 25,00

**TOUR**

bidet + kit fissaggio  
*bidet back to wall + fixing kit*



**ARTICOLO TU24I** – 27 kg | 10 pz pallet Italia | 20 pz pallet Export euro

**BIANCO LUCIDO**  **001**  
 bianco lucido  
 white 290

**COLORI DISPONIBILI**  **006**  **026**  **053**  
 bianco matt    nero matt    grigio matt  
 white matt    black matt    grey matt 430

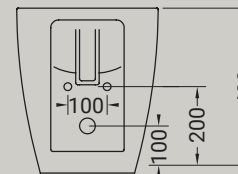
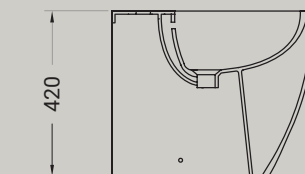
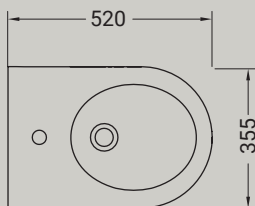

**TOUR**

coprivaso termoindurente slim  
*slim seat cover*



**ARTICOLO TUX** – 2,6 kg euro

**BIANCO LUCIDO**  **001**  
 bianco lucido  
 white 80

**TOUR**

coprivaso slim termoindurente caduta  
 rallentata sgancio rapido  
*seat cover slim soft closing system  
 quick release*



**ARTICOLO TUZ** – 2,6 kg euro

**BIANCO LUCIDO**  **001**  
 bianco lucido  
 white 130

**COLORI DISPONIBILI**  **006**  **026**  **053**  
 bianco matt    nero matt    grigio matt  
 white matt    black matt    grey matt 195

# TOUR 4.0



# TOUR 4.0

## WC

### **TUR40**

35,5X52 cm



### **TUWR40**

35,5X52 cm



## BIDET

### **TU44**

35,5X52 cm



### **TUW44**

35,5X52 cm







# TOUR 4.0

**La Tour 4.0 si propone come la base del design, una serie semplice e pulita, diretta e senza segreti, esce con un prezzo competitivo e un design moderno, la giusta combinazione per far fronte alle difficoltà del mercato attuale.**

*Tour 4.0 is meant to be the base of design, a clean range of sanitaryware that goes straight to the point, without any secrets. Is simple both in the design and in the price, certainly the right combination to succeed in this difficult market period.*







**TOUR 4.0**

vaso sospeso senza brida + kit fissaggio  
wc wall hung rimless + fixing kit



**ARTICOLO TUWR40** – 22 kg | 12 pz pallet Italia | 20 pz pallet Export

euro

BIANCO  
LUCIDO



**001**  
bianco lucido  
white

270

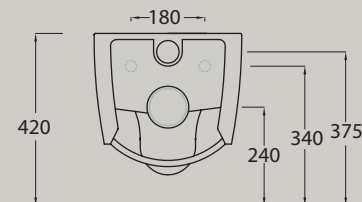
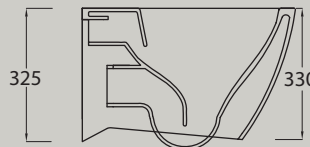
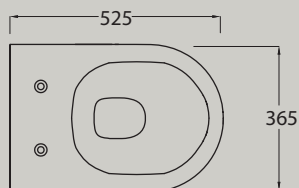

**TOUR 4.0**

bidet sospeso + kit fissaggio  
bidet wall hung + fixing kit



**ARTICOLO TUW44** – 20 kg | 12 pz pallet Italia | 20 pz pallet Export

euro

BIANCO  
LUCIDO



**001**  
bianco lucido  
white

270

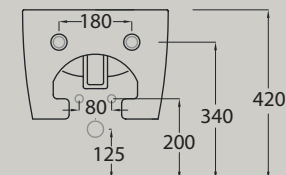
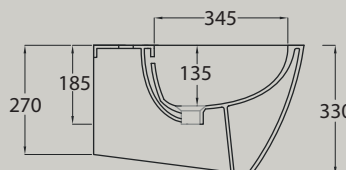
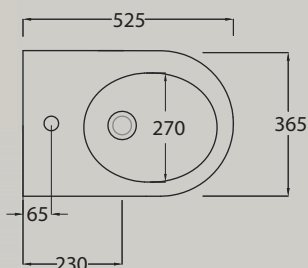

Accessori disponibili non inclusi/  
Available accessories not included  
art.P91

**SIFONE**  
P91 - sifone ribassato per bidet Euro 80,00  
P91 - CHROMED trap for washbasin Euro 80,00

**TOUR 4.0**

vaso senza brida filo parete + kit fissaggio  
wc back to wall rimless + fixing kit



**ARTICOLO TUR40** – 29 kg | 10 pz pallet Italia | 20 pz pallet Export

euro

BIANCO  
LUCIDO



**001**  
bianco lucido  
white

270

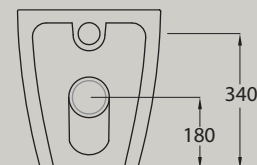
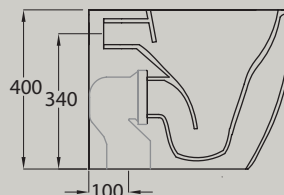
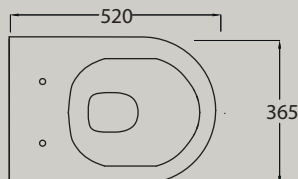

Accessori disponibili non inclusi/  
Available accessories not included  
art.P57 - P81

**CURVA**  
P57 - curva scarico pavimento Euro 25,00  
P57 - fvertical outlet plastic pipe Euro 25,00

**RACCORDO**  
P81 - raccordo di scarico parete Euro 25,00  
P81 - horizontal outlet plastic pipe Euro 25,00



**TOUR 4.0**

bidet + kit fissaggio  
 bidet back to wall + fixing kit

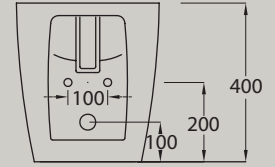
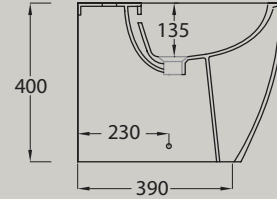
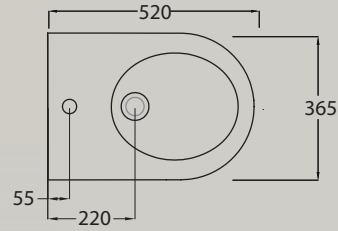
**ARTICOLO TU44** – 27 kg | 10 pz pallet Italia | 20 pz pallet Export

euro

BIANCO  
 LUCIDO



001  
 bianco lucido  
 white

270

**TOUR 4.0**

coprivaso slim termoindurente caduta  
 rallentata sgancio rapido  
 seat cover slim soft closing system  
 quick release

**ARTICOLO TUZQ** – 2,6 kg

euro

BIANCO  
 LUCIDO



001  
 bianco lucido  
 white

130

**MY**

# MY

## WC

### MR30

36X52 cm



### MWR20

36X52 cm



## BIDET

### M24

36X52 cm



### MW24

36X52 cm



## LAVABI

### M15

65X51 cm



### M22



### M16









**MY**

**MY come possesso, come “è mia”. E’ il mio bagno e di nessun altro. La collezione Hidra di MY è un connubio di semplicità e morbidezza, poche semplici curve morbide che modellano sapientemente la collezione rendendola flessibile e adatta a qualsiasi ambiente bagno. La collezione prevede sanitari a terra con piede, back to wall e sospesi 52 x 36. Il lavabo 65 x 50 prevede sia l’utilizzo di una colonna che di una semicolonna.**

*My is the italian word for 'mine'. Like a possession, like “it is mine!”: It is my bathroom and no one else. Mia collection from hidra is a combination of simplicity and softness, a few simple smooth curves that shape cleverly the range, making it flexible and suitable for any bathroom. The collection includes floor mounted, back to wall and wall hung sanitaryware 52x36. The washbasin 65x50 with column or half column.*



















**MY**

wc sospeso rimless + kit fissaggio  
wc wall hung rimless + fixing kit



<b>ARTICOLO MWR20</b> – 12 kg   12 pz pallet Italia   20 pz pallet Export		euro
BIANCO LUCIDO	 <b>001</b> bianco lucido white	220

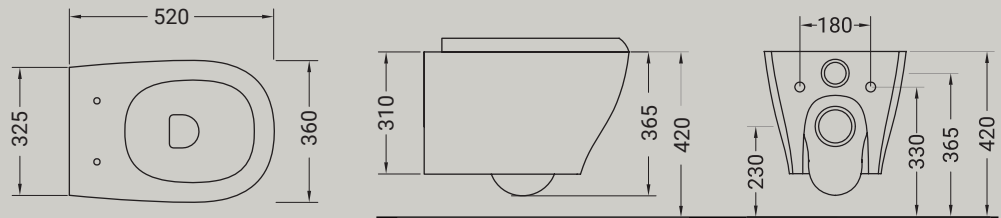

**MY**

bidet sospeso + kit fissaggio  
bidet wall-hung + fixing kit



<b>ARTICOLO MW24</b> – 12 kg   12 pz pallet Italia   20 pz pallet Export		euro
BIANCO LUCIDO	 <b>001</b> bianco lucido white	220

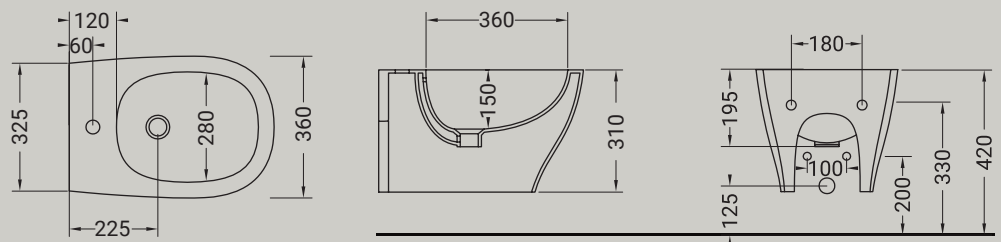

Accessori disponibili non inclusi/  
Available accessories not included  
art.P91

SIFONE  
P91 - sifone ribassato per bidet Euro 80,00  
P91 - CHROMED trap for washbasin Euro 80,00

**MY**

wc filo parete rimless  
wc back to wall rimless



Accessori disponibili non inclusi/  
Available accessories not included  
art.P57 - P81 - P33

**CURVA**

P57 - curva scarico pavimento Euro 25,00  
P57 - vertical outlet plastic pipe Euro 25,00

**RACCORDO**

P81 - raccordo di scarico parete Euro 25,00  
P81 - horizontal outlet plastic pipe Euro 25,00

**FISSAGGIO**

P33 - fissaggio vaso/bidet terra Euro 33,00  
P33 - floor fixing kit for WC/bidet Euro 33,00

**ARTICOLO MR30** – 28 kg | 10 pz pallet Italia | 20 pz pallet Export

euro

BIANCO  
LUCIDO



001  
bianco lucido  
white

200

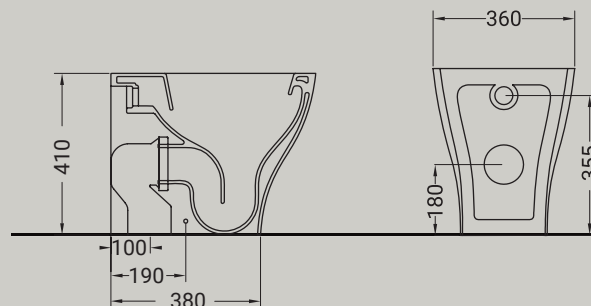
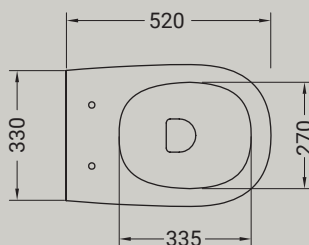

**MY**

bidet filo parete  
bidet back to wall



Accessori disponibili non inclusi/  
Available accessories not included  
art.P33

**FISSAGGIO**

P33 - fissaggio vaso/bidet terra Euro 33,00  
P33 - floor fixing kit for WC/bidet Euro 33,00

**ARTICOLO M24** – 24,5 kg | 10 pz pallet Italia | 20 pz pallet Export

euro

BIANCO  
LUCIDO



001  
bianco lucido  
white

200

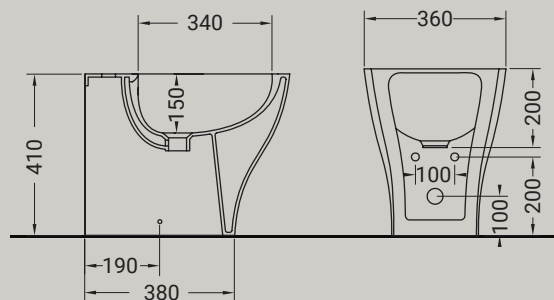
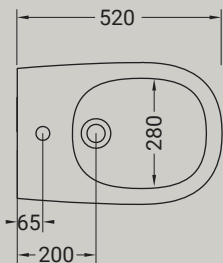

**MY**  
coprivaso termoidurente  
*cover*



<b>ARTICOLO MO</b> – 2,2 kg		euro
BIANCO LUCIDO	 <b>001</b> bianco lucido <i>white</i>	70

**MY**  
coprivaso slim caduta rallentata  
sgancio rapido  
*soft close slim seat cover quick release*



<b>ARTICOLO MZSQ</b> – 3 kg		euro
BIANCO LUCIDO	 <b>001</b> bianco lucido <i>white</i>	130

**MY**  
cassetta alta  
*high cistern*



<b>ARTICOLO C19</b> – 8,3 kg		euro
BIANCO LUCIDO	 <b>001</b> bianco lucido <i>white</i>	65



**MY**

lavabo su colonna  
washbasin



Accessori disponibili non inclusi/  
Available accessories not included  
art.P22 - P82 - P125

**FISSAGGIO**

P22 - sistema fissaggio per lavabi sospesi per muro portante Euro 10,00  
P22 - fixing kit for wall-hung washbasin for load-bearing wall Euro 10,00

**SIFONE**

P82 - sifone CROMO per lavabo Euro 90,00  
P82 - CHROMED trap for washbasin Euro 90,00

**PILETTA**

P125 - piletta click-clack o flusso continuo per lavabo con copertura in ceramica Euro 72,00  
P125 - click-clack drain or open outlet drain for washbasin with ceramic cover Euro 72,00

**ARTICOLO M15** – 20,7 kg | 18 pz pallet Italia | 24 pz pallet Export

euro

BIANCO  
LUCIDO



140

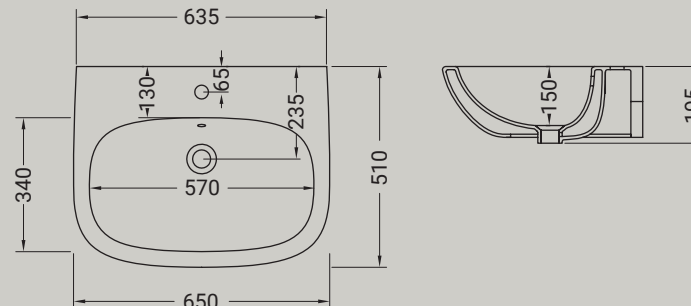

**MY**

semicolonna  
semipedestal



**ARTICOLO M22** – 7 kg

euro

BIANCO  
LUCIDO



65

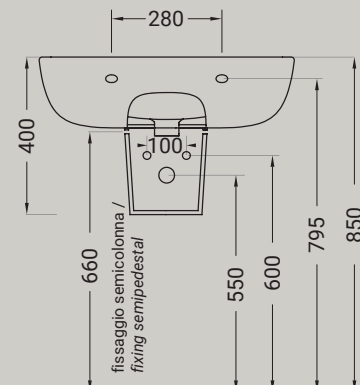

**MY**

colonna per lavabi  
pedestal for washbasin



**ARTICOLO M16** – 13 kg

euro

BIANCO  
LUCIDO



65

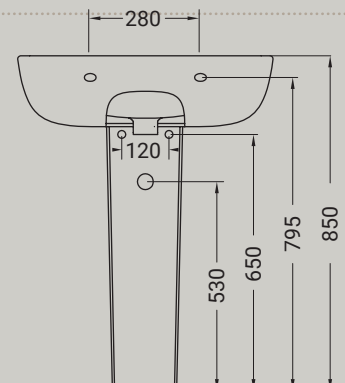

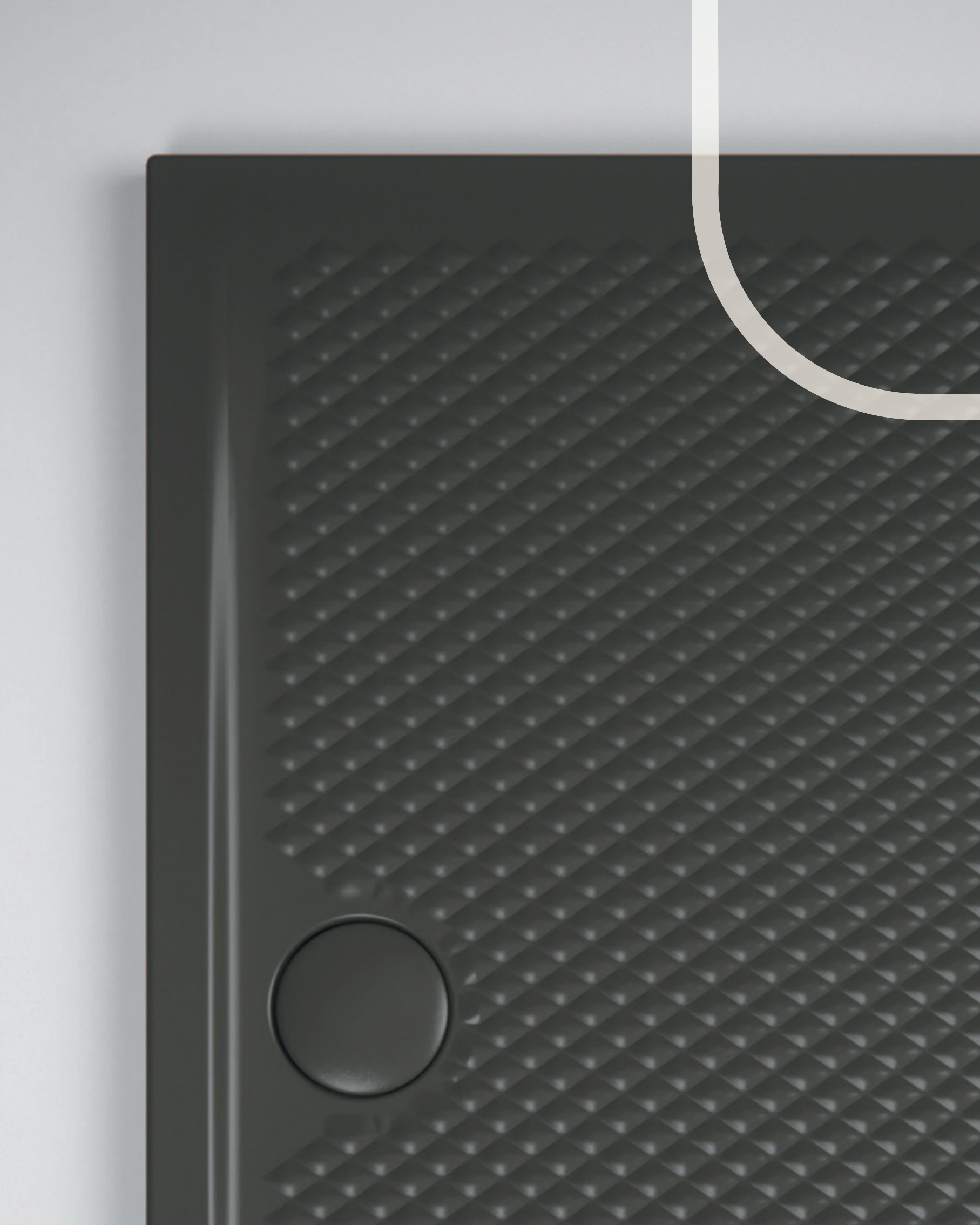

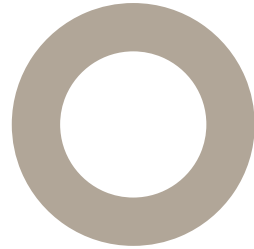

# PIATTI DOCCIA

MADE IN ITALY

Una trama eterea e senza tempo, composto da una ripetizione di piccoli rombi accostati, con il duplice scopo decorativo e funzionale, fornendo il grip antiscivolo. Texture è la collezione di piatti doccia slim, con altezza di soli 5 cm. I piatti doccia sono disponibili nei colori bianco matt-nero matt-grigio matt-marrone matt-verde matt e rosa matt nei formati 90x90, 90x72, 100x70, 100x80, 120x70, 120x80 e 140x80.

*An ethereal and timeless draw, made up of a repetition of small rombi, with the dual purpose, decorative and functional, giving the anti-slip grip. Texture is the shower trays collection, with only 5 cm of height. The shower trays are available in white matt-black matt-grey matt-brown matt-green matt e pink matt with the next sizes 90x90, 90x72, 100x70, 100x80, 120x70, 120x80 and 140x80.*







006  
BIANCO MATT  
*white matt*



026  
NERO MATT  
*black matt*



053  
GRIGIO MATT  
*grey matt*



096  
MARRONE MATT  
*brown matt*



052  
VERDE MATT  
*green matt*



097  
ROSA MATT  
*pink matt*

**TEXTURE - PIATTO DOCCIA**

piatto doccia texture 90x90  
shower tray texture 90x90



**ARTICOLO TXT225** — 30 kg | 10 pz pallet Italia | 10 pz pallet Export

euro

BIANCO  
LUCIDO



**001**  
bianco lucido  
white

240

COLORI  
DISPONIBILI



**006**  
bianco matt  
white matt



**026**  
nero matt  
black matt



**053**  
grigio matt  
grey matt



**096**  
marrone matt  
brown matt



**052**  
verde matt  
green matt



**097**  
rosa matt  
pink matt

385

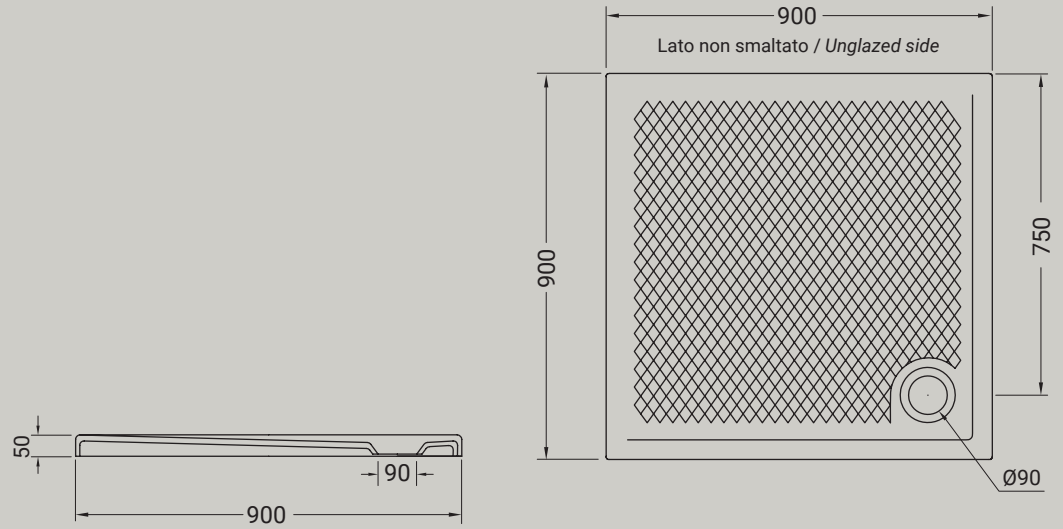

**TEXTURE - PIATTO DOCCIA**

piatto doccia texture 72x90  
shower tray texture 72x90



**ARTICOLO TXT209** — 28 kg | 10 pz pallet Italia | 10 pz pallet Export

euro

BIANCO  
LUCIDO



**001**  
bianco lucido  
white

220

COLORI  
DISPONIBILI



**006**  
bianco matt  
white matt



**026**  
nero matt  
black matt



**053**  
grigio matt  
grey matt



**096**  
marrone matt  
brown matt



**052**  
verde matt  
green matt



**097**  
rosa matt  
pink matt

350

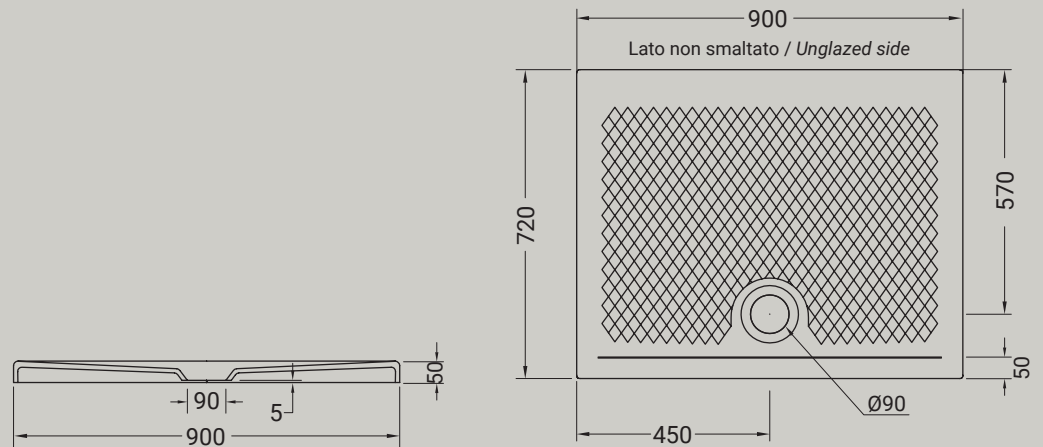



### TEXTURE - PIATTO DOCCIA

piatto doccia texture 70x100  
shower tray texture 70x100



**ARTICOLO TXT213** — 31 kg | 10 pz pallet Italia | 10 pz pallet Export

euro

BIANCO  
LUCIDO



**001**  
bianco lucido  
white

260

COLORI  
DISPONIBILI



**006**  
bianco matt  
white matt



**026**  
nero matt  
black matt



**053**  
grigio matt  
grey matt



**096**  
marrone matt  
brown matt



**052**  
verde matt  
green matt



**097**  
rosa matt  
pink matt

420

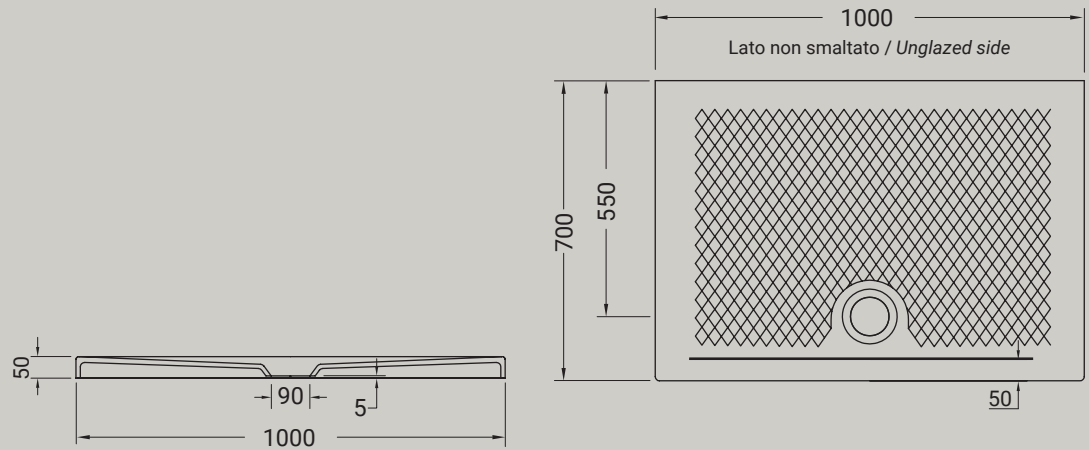

### TEXTURE - PIATTO DOCCIA

piatto doccia texture 70x120  
shower tray texture 70x120



**ARTICOLO TXT211** — 37 kg | 10 pz pallet Italia | 10 pz pallet Export

euro

BIANCO  
LUCIDO



**001**  
bianco lucido  
white

330

COLORI  
DISPONIBILI



**006**  
bianco matt  
white matt



**026**  
nero matt  
black matt



**053**  
grigio matt  
grey matt



**096**  
marrone matt  
brown matt



**052**  
verde matt  
green matt



**097**  
rosa matt  
pink matt

530

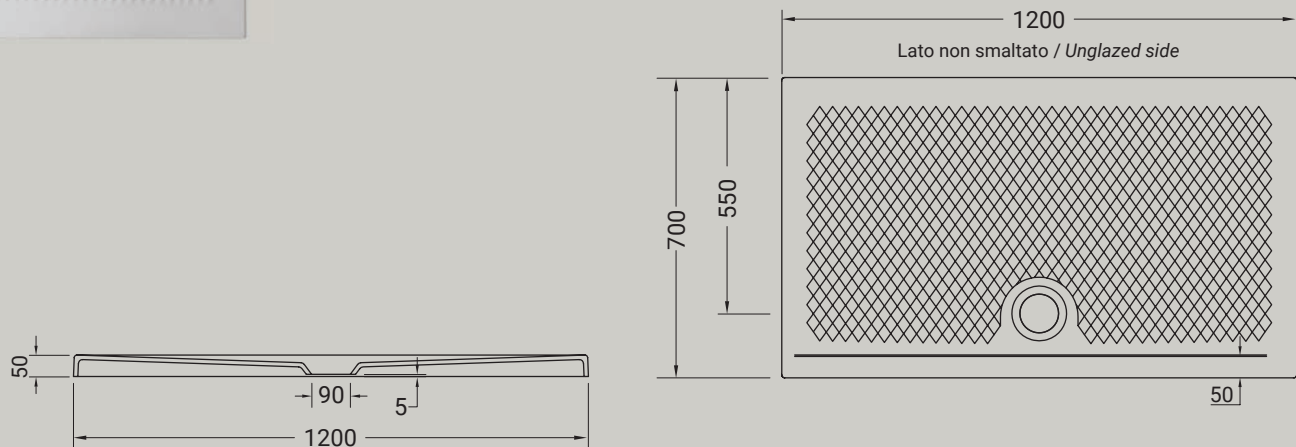

**TEXTURE - PIATTO DOCCIA**

piatto doccia texture 80x120  
shower tray texture 80x120



**ARTICOLO TXT210** — 41 kg | 10 pz pallet Italia | 10 pz pallet Export

euro

BIANCO  
LUCIDO



**001**  
bianco lucido  
white

370

COLORI  
DISPONIBILI



**006**  
bianco matt  
white matt



**026**  
nero matt  
black matt



**053**  
grigio matt  
grey matt



**096**  
marrone matt  
brown matt



**052**  
verde matt  
green matt



**097**  
rosa matt  
pink matt

590

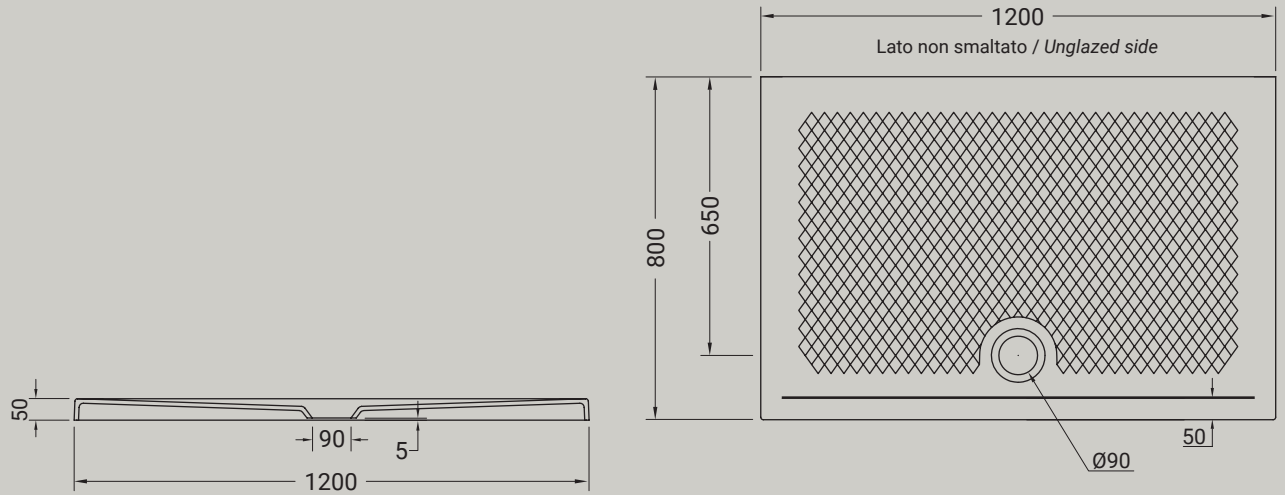

**TEXTURE - PIATTO DOCCIA**

piatto doccia texture 80x100  
shower tray texture 80x100



**ARTICOLO TXT217** — 33 kg | 10 pz pallet Italia | 10 pz pallet Export

euro

BIANCO  
LUCIDO



**001**  
bianco lucido  
white

300

COLORI  
DISPONIBILI



**006**  
bianco matt  
white matt



**026**  
nero matt  
black matt



**053**  
grigio matt  
grey matt



**096**  
marrone matt  
brown matt



**052**  
verde matt  
green matt



**097**  
rosa matt  
pink matt

480

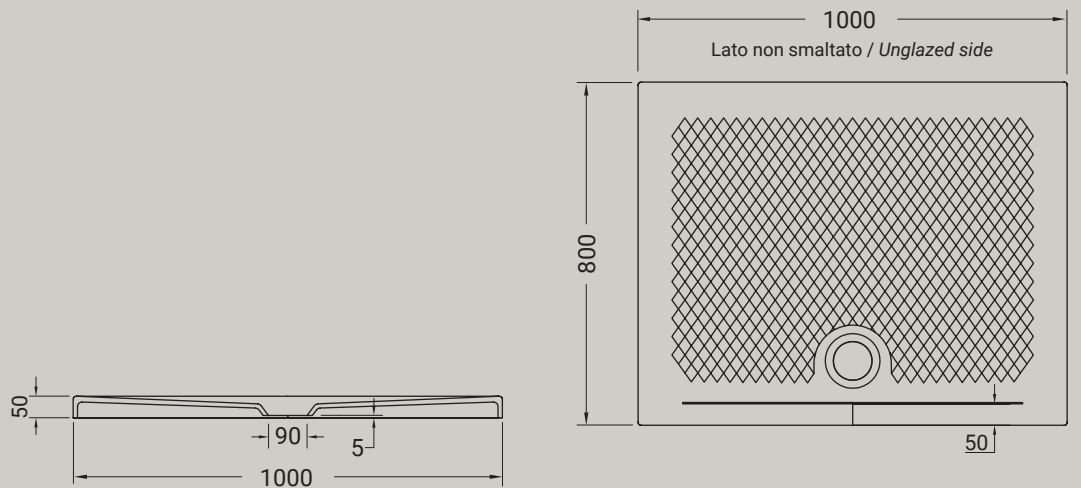

## TEXTURE - PIATTO DOCCIA

piatto doccia texture 80x140  
shower tray texture 80x140

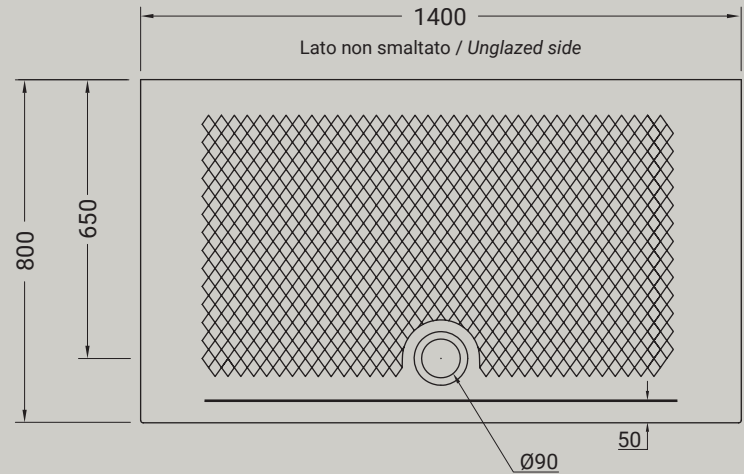
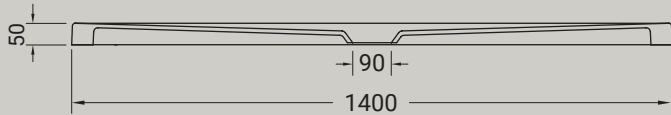

<b>ARTICOLO TXT140</b> – 43 kg   10 pz pallet Italia   10 pz pallet Export		euro
<b>BIANCO LUCIDO</b>	<b>001</b> bianco lucido white	590
<b>COLORI DISPONIBILI</b>	<b>006</b> bianco matt / white matt <b>026</b> nero matt / black matt <b>053</b> grigio matt / grey matt <b>096</b> marrone matt / brown matt <b>052</b> verde matt / green matt <b>097</b> rosa matt / pink matt	885

## PILETTA PD

piletta per piatto doccia diam.90  
siphoned outlet for shower tray diam.90



<b>ARTICOLO P13</b> – 0,4kg		euro
<b>DECORO DISPONIBILE</b>	<b>001</b> cromo chrome	50

## PILETTA PD

piletta per piatto doccia con copertura in ceramica bianca o colorata  
siphoned outlet for shower tray with ceramic cover white or colorated



<b>ARTICOLO P126</b> – 0,4kg		euro
<b>COLORI DISPONIBILI</b>	<b>001</b> bianco lucido / white shine <b>006</b> bianco matt / white matt <b>026</b> nero matt / black matt <b>053</b> grigio matt / grey matt <b>096</b> marrone matt / brown matt <b>052</b> verde matt / green matt <b>097</b> rosa matt / pink matt	85







# LAVABI

TAO  
POLIS  
SOTTOPIANO  
SEMINCASSO  
INCASSO

# TAO

MADE IN ITALY





## TAO

lavabo tondo da appoggio cm. 43  
round countertop washbasin cm. 43

Accessori disponibili non inclusi/  
Available accessories not included  
art. P85 - P90 - P125

**FISSAGGIO**  
P85 - sistema fissaggio per lavabi appoggio Euro 10,00  
P85 - fixing kit for countertop washbasin Euro 10,00

**PILETTA**  
P90 - piletta flusso continuo per lavabo Euro 72,00  
P125 - piletta click-clack o flusso continuo per lavabo con copertura in ceramica Euro 72,00

P90 - open outlet drain for washbasin Euro 72,00  
P125 - click-clack drain or open outlet drain for washbasin with ceramic cover Euro 72,00

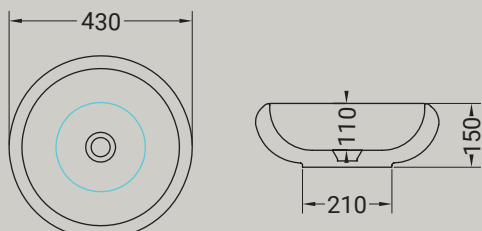

## TAO

lavabo ovale da appoggio cm. 60  
oval countertop washbasin cm. 60

Accessori disponibili non inclusi/  
Available accessories not included  
art. P85 - P90 - P125

**FISSAGGIO**  
P85 - sistema fissaggio per lavabi appoggio Euro 10,00  
P85 - fixing kit for countertop washbasin Euro 10,00

**PILETTA**  
P90 - piletta flusso continuo per lavabo Euro 72,00  
P125 - piletta click-clack o flusso continuo per lavabo con copertura in ceramica Euro 72,00

P90 - open outlet drain for washbasin Euro 72,00  
P125 - click-clack drain or open outlet drain for washbasin with ceramic cover Euro 72,00

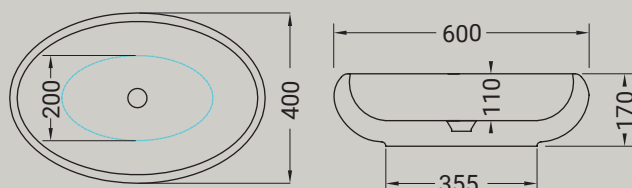

## TAO

lavabo ovale da appoggio cm.75  
oval countertop washbasin cm. 75

Accessori disponibili non inclusi/  
Available accessories not included  
art. P85 - P90 - P125





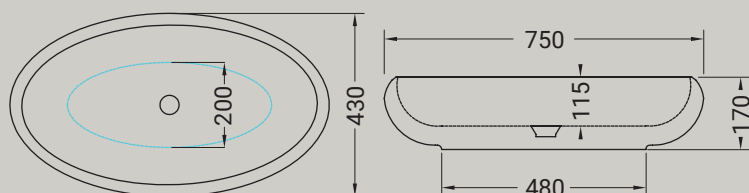

**FISSAGGIO**  
P85 - sistema fissaggio per lavabi appoggio Euro 10,00  
P85 - fixing kit for countertop washbasin Euro 10,00

**PILETTA**  
P90 - piletta flusso continuo per lavabo Euro 72,00  
P125 - piletta click-clack o flusso continuo per lavabo con copertura in ceramica Euro 72,00







P90 - open outlet drain for washbasin Euro 72,00  
P125 - click-clack drain or open outlet drain for washbasin with ceramic cover Euro 72,00









### ARTICOLO TA19 — 7,3 kg | 34 pz pallet Italia | 60 pz pallet Export euro

BIANCO LUCIDO		001 bianco lucido white	210		
COLORI DISPONIBILI	 	006 bianco matt white matt	026 nero matt black matt	315	
DECORI DISPONIBILI	  	013 bianco/oro white/gold	014 bianco/platino white/platinum	063 bianco/oro rosa white/rose gold	510
DECORI DISPONIBILI		020 nero/oro black/gold		615	

### ARTICOLO TA20 — 12,8 kg | 20 pz pallet Italia | 34 pz pallet Export euro

BIANCO LUCIDO		001 bianco lucido white	280		
COLORI DISPONIBILI	 	006 bianco matt white matt	026 nero matt black matt	420	
DECORI DISPONIBILI	  	013 bianco/oro white/gold	014 bianco/platino white/platinum	063 bianco/oro rosa white/rose gold	610
DECORI DISPONIBILI		020 nero/oro black/gold		750	

### ARTICOLO TA21 — 16,2 kg | 12 pz pallet Italia | 26 pz pallet Export euro

BIANCO LUCIDO		001 bianco lucido white	330		
COLORI DISPONIBILI	 	006 bianco matt white matt	026 nero matt black matt	500	
DECORI DISPONIBILI	  	013 bianco/oro white/gold	014 bianco/platino white/platinum	063 bianco/oro rosa white/rose gold	650
DECORI DISPONIBILI		020 nero/oro black/gold		800	



**POLIS**

lavabo tondo da appoggio cm. 41  
round countertop washbasin cm. 41

Accessori disponibili non inclusi/  
Available accessories not included  
art.P90 - P125

**PILETTA**

P90 - piletta flusso continuo per lavabo Euro 72,00  
P125 - piletta click-clack o flusso continuo per  
lavabo con copertura in ceramica Euro 72,00

P90 - open outlet drain for washbasin Euro 72,00  
P125 - click-clack drain or open outlet drain for  
washbasin with ceramic cover Euro 72,00

**ARTICOLO A42 -** 4,9 kg | 34 pz pallet Italia | 60 pz pallet Export

euro

BIANCO  
LUCIDO



**001**  
bianco lucido  
white

190

COLORI  
DISPONIBILI



**006**  
bianco matt  
white matt



**026**  
nero matt  
black matt

285

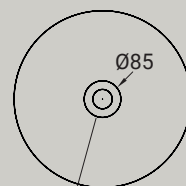
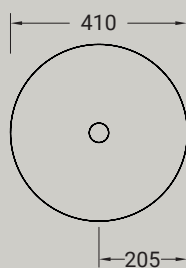

scasso su piano  
cut on plan

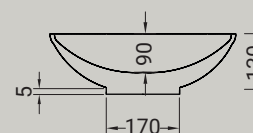



**LAVABI**

lavabo sottopiano 57x40  
under countertop wash basin 57x40

Accessori disponibili non inclusi/  
Available accessories not included  
art.P93



FISSAGGIO  
P93 - sistema fissaggio per lavandini sottopiano Euro 10,00  
P93 - fixing kit for inset washbasin Euro 10,00

**ARTICOLO A104** – 10 kg | 16 pz pallet Italia | 32 pz pallet Export euro

BIANCO  
LUCIDO



001  
bianco lucido  
white

120

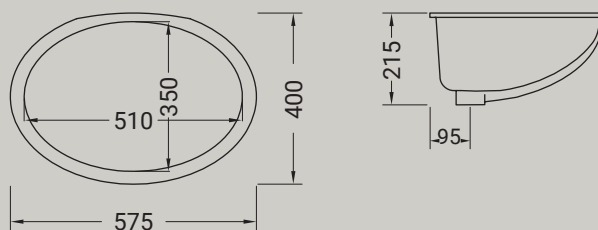
**LAVABI**

lavabo incasso 58x48  
inset wash basin 58x48



**ARTICOLO A105** – 7,5 kg | 16 pz pallet Italia | 28 pz pallet Export euro

BIANCO  
LUCIDO



001  
bianco lucido  
white

180

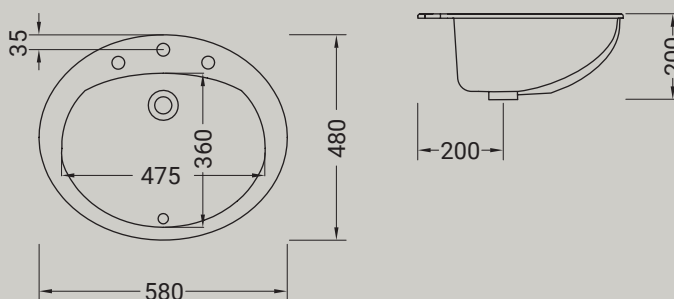
**LAVABI**

lavabo sottopiano 53x34,5  
wash basin under countertop 53x34,5

Accessori disponibili non inclusi/  
Available accessories not included  
art.P93



FISSAGGIO  
P93 - sistema fissaggio per lavandini sottopiano Euro 10,00  
P93 - fixing kit for inset washbasin Euro 10,00

**ARTICOLO A109** – 7 kg | 20 pz pallet Italia | 32 pz pallet Export euro

BIANCO  
LUCIDO



001  
bianco lucido  
white

140

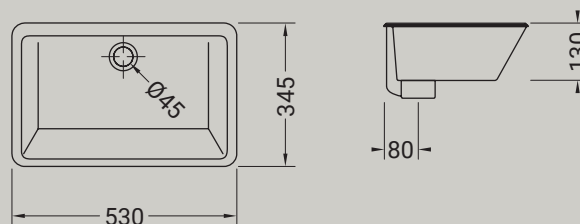

**LAVABI**

lavabo sottopiano 90x33  
*wash basin under countertop 90x33*

Accessori disponibili non inclusi/  
*Available accessories not included*  
 art.P93



**FISSAGGIO**  
 P93 - sistema fissaggio per lavandini sottopiano Euro 10,00  
*P93 - fixing kit for inset washbasin Euro 10,00*

**ARTICOLO A110** — 15,9 kg | 12 pz pallet Italia | 18 pz pallet Export euro

BIANCO  
 LUCIDO



001  
 bianco lucido  
*white*

220

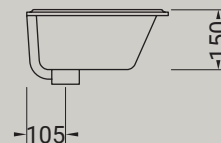

**LAVABI**

lavabo sottopiano nettuno 55x38  
*wash basin under countertop nettuno 55x38*

Accessori disponibili non inclusi/  
*Available accessories not included*  
 art.P93



**FISSAGGIO**  
 P93 - sistema fissaggio per lavandini sottopiano Euro 10,00  
*P93 - fixing kit for inset washbasin Euro 10,00*

**ARTICOLO A118** — 8 kg | 20 pz pallet Italia | 32 pz pallet Export euro

BIANCO  
 LUCIDO



001  
 bianco lucido  
*white*

120

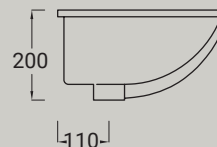
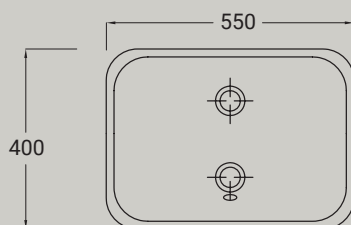









# ACCESSORI

**PILETTA PER TEXTURE PD**

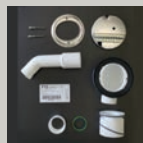
piletta per piatto doccia diam.90  
siphoned outlet for shower tray diam.90



<b>ARTICOLO P13</b> – 0,4kg	euro
DECORO DISPONIBILE	50
 cromo chrome	

**PILETTA PER TEXTURE PD**

piletta per piatto doccia con copertura  
in ceramica bianca o colorata  
siphoned outlet for shower tray with ceramic  
cover white or colorated



<b>ARTICOLO P126</b> – 0,4kg	euro					
COLORI DISPONIBILI	85					
 <b>001</b> bianco lucido white shine	 <b>006</b> bianco matt white matt	 <b>026</b> nero matt black matt	 <b>053</b> grigio matt grey matt	 <b>096</b> marrone matt brown matt	 <b>052</b> verde matt green matt	 <b>097</b> rosa matt pink matt

**PILETTA**

piletta click-clack o flusso continuo per  
lavabo con copertura in ceramica  
click-clack drain or open outlet drain for  
washbasin with ceramic cover

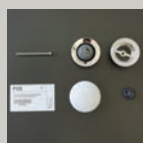

<b>ARTICOLO P125</b> – 0,4kg	euro					
COLORI DISPONIBILI	72					
 <b>001</b> bianco lucido white shine	 <b>006</b> bianco matt white matt	 <b>026</b> nero matt black matt	 <b>053</b> grigio matt grey matt	 <b>096</b> marrone matt brown matt	 <b>052</b> verde matt green matt	 <b>097</b> rosa matt pink matt
 <b>009</b> shine nero shine black	 <b>106</b> shine green	 <b>108</b> shine grey	 <b>105</b> shine red	 <b>109</b> shine yellow	 <b>107</b> shine blu	 <b>116</b> shine pink
TEXTURE DISPONIBILI	72					
 <b>100</b> ceppo di gré grey	 <b>101</b> white matt marble	 <b>103</b> green alpes green alpes	 <b>104</b> black gold marble			

**PILETTA**

piletta click-clack per lavabo  
click-clack drain for washbasin



<b>ARTICOLO P89</b> – 0,4 kg	euro
	60

**PILETTA**

piletta flusso continuo per lavabo  
open outlet drain for washbasin



<b>ARTICOLO P90</b> – 0,4 kg	euro
	72

**SIFONE WIRE**

sifone CROMO scarico terra  
CHROMED trap for floor waste

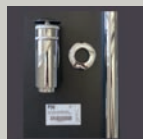

<b>ARTICOLO P50</b> – 1,8 kg	euro
DECORO DISPONIBILE	300
 cromo chrome	

**SIFONE**

sifone CROMO per lavabo  
*CHROMED trap for washbasin*

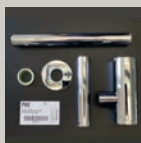

**ARTICOLO P82** — 0,4 kg euro

DECORO  
DISPONIBILE



cromo  
chrome

90

**SIFONE**

sifone per lavabo  
*trap for washbasin*

**ARTICOLO P82N** — 0,4 kg euro

COLORI  
DISPONIBILI



026  
nero matt  
black matt

150

**SIFONE**

sifone ribassato per bidet  
*CHROMED trap for washbasin*

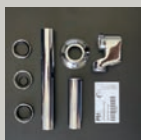

**ARTICOLO P91** — 0,6 kg euro

80

**SIFONE DROP**

sifone per orinatoio DROP DR01  
*DROP trap for urinal*

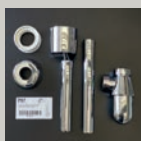

**ARTICOLO P97** — 0,5 kg euro

75

**SIFONE DROP**

sensores per orinatoio DROP DR01  
*DROP electronic system*

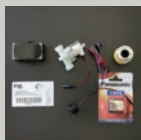

**ARTICOLO P98** — 0,1 kg euro

350

**CISTERNA**

cisterna in pvc con dispositivo di scarico  
 doppio flusso geberit CROMO, ORO, BRONZO  
 per articolo d118 e d28  
*plastic cistern with wast system double flow  
 CHROME, GOLD, BRONZE for article d118 and  
 d28*

**ART. P10 CISTERNA IN PVC CON DISPOSITIVO DI SCARICO DOPPIO FLUSSO** —2,8 kg euro

ARTICOLO  
P10



cromo  
chrome

180

ARTICOLO  
P100



oro  
gold

210

ARTICOLO  
P10B



bronzo  
bronze

210



**MECCANISMO ELLADE**

meccanismo CROMO, ORO, BRONZO per D58  
flushing system with front handle and external  
CHROME, GOLD, BRONZE waste tube for D58

**MECCANISMO PER D58** – 1,5 kg euro

ARTICOLO  
P18



cromo  
chrome

215

ARTICOLO  
P19



oro  
gold

300

ARTICOLO  
P20



bronzo  
bronze

300

**MECCANISMO**

meccanismo di scarico doppio flusso geberit  
per FA18 entrata acqua bassa/alta  
geberit dual flushing system high and low  
water inlet for FA18

**ARTICOLO P7576** – 1,1 kg euro

90

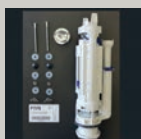
**MECCANISMO**

meccanismo di scarico ORO, CROMO,  
BRONZO, doppio flusso per D18 entrata  
acqua bassa/alta  
GOLD, CHROME, BRONZE, dual flushing  
system low and high low water inlet for D18

**MECCANISMO DI SCARICO DOPPIO FLUSSO BASSA/ALTA PER D18** – 0,8 kg euro

ARTICOLO  
P7778



cromo  
chrome

90

ARTICOLO  
P7778O



oro  
gold

110

ARTICOLO  
P7778BR



bronzo  
bronze

110

**FISSAGGIO**

sistema fissaggio per lavabi sospesi  
per muro portante  
fixing kit for wal-hung washbasin for  
load-bearing wall

**ARTICOLO P22** – 0,2 kg euro

10

**FISSAGGIO**

fissaggio vaso/bidet terra  
floor fixing kit for WC/bidet

**ARTICOLO P33** – 0,1 kg euro

15



**FISSAGGIO**

kit fissaggio ghost per sanitari terra  
*ghost fixing*



<b>ARTICOLO P44</b> – 0,3 kg	euro
	20

**FISSAGGIO**

sistema fissaggio per vaso e bidet sospesi  
Ellade - Faster - Faster Kiub Giò - Tour - My -  
Venus  
*fixing kit for wall-hung wc+bidet Ellade Faster -  
Faster Kiub - Giò - Tour - My Venus*

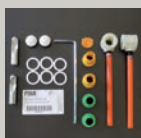

<b>ARTICOLO P58</b> – 0,3 kg	euro
	20

**FISSAGGIO**

kit fissaggio sanitari verticale CROMO, ORO,  
BIANCO  
*fixing kit vertical CHROME, GOLD, WHITE*

<b>KIT FISSAGGIO SANITARI VERTICALE</b> – 0,1 kg	euro
--	------

<b>ARTICOLO P66</b>	 cromo <i>chrome</i>	10
---------------------	---	----

<b>ARTICOLO P66O</b>	 oro <i>gold</i>	10
----------------------	---	----

<b>ARTICOLO P66BI</b>	 bianco lucido <i>white shine</i>	10
-----------------------	--	----

**FISSAGGIO**

sistema fissaggio per lavabi appoggio  
*fixing kit for countertop washbasin*



<b>ARTICOLO P85</b> – 0,1 kg	euro
	10

**FISSAGGIO**

sistema fissaggio per lavabi sottopiano  
*fixing kit for inset washbasin*

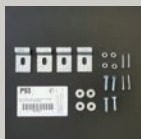

<b>ARTICOLO P93</b> – 0,1 kg	euro
	10

**RACCORDO**

raccordo scarico pavimento  
vertical outlet plastic pipe



**ARTICOLO P57** – 0,6 kg

euro

25

**RACCORDO**

raccordo pavimento L  
connection to the floor L



**ARTICOLO P59** – 0,6 kg

euro

30

**RACCORDO**

raccordo traslato a pavimento  
adjustable connection to the floor



**ARTICOLO P60** – 0,6 kg

euro

30

**RACCORDO**

raccordo di scarico parete  
horizontal outlet plastic pipe



**ARTICOLO P81** – 0,3 kg

euro

25

**RACCORDO**

raccordo carico acqua  
connection inlet water



**ARTICOLO P61** – 0,6 kg

euro

25



**CERNIERE**

cerniere sedile normale - cromo  
*hinges for seat cover - chrome*



<b>ARTICOLO P79</b> – 0,1 kg	euro
	30

**CERNIERE**

cerniere sedile rallentato  
*hinges for soft closing seat cover*

<b>ARTICOLO P80</b> – 0,2 kg	euro
------------------------------	------

DECORO DISPONIBILE	 cromo chrome	60
--------------------	---	----

DECORO DISPONIBILE	 oro gold	 bronzo bronze	100
--------------------	---	--	-----

**PARACOLPI**

paracolpi sedile  
*buffers for seat cover*

<b>ARTICOLO P94</b> – 0,0 kg	euro
------------------------------	------

4

**STAFFE**

staffe di fissaggio per sospesi  
*fitting system kit for wall hung*

<b>ARTICOLO P99</b> – 2,8 kg	euro
------------------------------	------

45

**RIDUTTORE**

riduttore regolabile per adduzione wc  
*water flushing reducer*

<b>ARTICOLO P116</b> – 0,1 kg	euro
-------------------------------	------

20

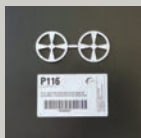

"PER IMMAGINI E DETTAGLI TECNICI VISITARE IL SITO [WWW.HIDRA.IT](http://WWW.HIDRA.IT) NELLA SEZIONE DOWNLOAD"

"FOR ALL THE IMAGES AND TECHNICAL DETAILS VISIT OUR WEB SITE [WWW.HIDRA.IT](http://WWW.HIDRA.IT) IN THE DOWNLOAD AREA"

## Condizioni generali di vendita

### DISPOSIZIONI GENERALI

Le presenti condizioni di vendita e di consegna si intendono integralmente accettate dal Committente con il conferimento dell'ordine o con il ritiro dei materiali. Vengono respinte le eventuali condizioni generali di contratto del Compratore.

### ACCETTAZIONE ORDINI

Gli ordini sono da intendersi subordinati all'accettazione di Hidra Ceramica Srl.

### PREZZI

I prezzi possono essere variati senza nessun preavviso e si intendono pattuiti secondo i listini in vigore al momento della consegna. I prezzi contenuti nel presente listino sono da intendersi franco fabbrica e IVA esclusa.

### PAGAMENTO

I termini di pagamento si intendono tassativi e decorrono dalla data di fatturazione. I pagamenti devono essere effettuati direttamente ad Hidra Ceramica Srl presso la sua sede. Qualsiasi ritardo imputabile al Committente o qualsiasi contestazione sorgesse fra le parti, anche relativamente alle garanzie concesse, non produrrà alcun prolungamento o modifica nei termini dei pagamenti convenuti ed ogni azione ed eccezione del Committente non sarà ritenuta procedibile, se lo stesso non proverà di essere in regola coi pagamenti. Nel caso di mora in qualsiasi pagamento potranno essere sospese ed annullate le forniture in corso. Decorso il termine di pagamento stabilito in fattura senza che ne sia avvenuto il regolamento, Hidra Ceramica Srl avrà la facoltà di emettere tratta a vista per l'ammontare dell'intero credito aumentato delle spese. L'eventuale ritardo nel pagamento comporterà l'addebito di interessi al tasso corrente di mercato, aumentato del 2%. Nel caso di inosservanza di uno dei termini di scadenza anche tutte le altre fatture del venditore saranno immediatamente esigibili. L'esigibilità di tutte le fatture si verifica anche nell'ipotesi in cui il venditore venga a conoscenza di altre circostanze che lascino temere una cattiva situazione finanziaria del compratore (per esempio: emissione di assegni scoperti, cambiali protestate, procedimenti di sequestro, ecc.)

### TERMINI DI CONSEGNA, RITARDI O IMPEDIMENTI DI FORNITURA

Allorché viene indicato un termine di consegna, questo ha valore semplicemente informativo e non impegnativo, essendo subordinato a qualunque imprevisto. La consegna della merce si intende eseguita con la messa a disposizione della merce presso il nostro stabilimento di Civita Castellana (Italia). Interruzioni di lavoro conseguenti a cause di forza maggiore dispensano Hidra Ceramica Srl dall'osservare il termine di consegna indicato, senza peraltro dare diritto al Committente di esigere risarcimenti dovuti a danni di qualsiasi natura. La merce dovrà essere sempre ritirata dal Committente e non dovrà essere in ogni caso lasciata giacente. Le eventuali spese di giacenza, magazzinaggio, ecc. saranno comunque a carico del Committente.

### TRASPORTO

Salve condizioni particolari, la merce è venduta franco nostro stabilimento ed in ogni caso viaggia a rischio e pericolo del Committente anche se resa franco destino. Sono consentite forniture parziali e anticipate. Il trasporto è a carico del Committente. Le spedizioni avvengono per conto ed incarico del Committente, il quale, in caso di avarie, rotture o ammanchi, deve notificarlo alla nostra azienda, tramite il vettore, al momento della consegna. La merce consegnata rimane di riservato dominio della venditrice fino all'avvenuto pagamento. I termini di consegna si intendono sempre indicativi ed in relazione alle possibilità del momento. Non si assume nessuna responsabilità per ritardi o mancate consegne per fatti o atti indipendenti dalla nostra volontà ed eventuali richieste di risarcimento danni per ritardi di consegna non saranno accettati.

### IMBALLAGGIO

L'imballaggio viene effettuato in pallets e retraibile. Il costo dell'imballaggio è a carico del Committente, salvo patto contrario risultante dalla conferma d'ordine. A parziale recupero delle spese di imballo viene addebitato il 3%.

### RESPONSABILITA'

Qualora il materiale risultasse difettoso per vizi di fabbricazione riconosciuti a seguito di accertamenti tecnici, Hidra si riserva di sostituirlo o accreditare il valore nei tempi previsti dalla Normativa vigente. In alcun caso la responsabilità può estendersi ai danni diretti e indiretti che dovessero derivare anche dalla messa in opera del materiale difettoso. E' fatto onere al compratore di controllare ogni articolo non appena preso in consegna, e così in particolare di aprire le confezioni, gli imballaggi e le scatole di contenimento; il termine decadenziale di legge per i vizi evidenti decorre dal momento della consegna stessa.

### RECLAMI

Non si accettano reclami di nessun genere trascorsi otto giorni dal ricevimento della merce. Eventuali reclami dovranno essere fatti a mezzo lettera raccomandata entro tale termine. In ogni caso nessuna contestazione verrà accettata per materiali già posti in opera.

### CARATTERISTICHE TECNICHE E COLORI

Hidra Ceramica Srl si riserva la facoltà di modificare le caratteristiche al fine di migliorare tecnicamente ed esteticamente il prodotto o sospendere la produzione dei modelli in qualsiasi momento senza preavviso. Pesi e misure sono da considerarsi indicativi. Le misure di installazione, riportate nei cataloghi, possono presentare differenze rispetto ai pezzi reali in considerazione delle peculiari caratteristiche di fabbricazione degli articoli in ceramica

### FORO COMPETENTE

Qualsiasi controversia fra Hidra Ceramica Srl e il Committente sarà di competenza soltanto del Foro di Viterbo (Italia), esclusa qualsiasi altra deroga, anche nel caso di chiamata in giudizio per garanzia, connessione, contingenza di lite.

## General sales conditions

### GENERAL CONDITIONS

The present conditions of sale and delivery are considered as fully accepted by the Purchaser upon the order or the collection of the goods. Any general conditions of sale of the Purchaser are rejected.

### ACCETTAZIONE ORDINI

The orders are anyway subject to the prior consent of Hidra Ceramica Srl.

### PRICES

Prices may be charged without notice and are agreed according to the price list in force on delivery. The prices of the present price list are meant ex factory and don't include V.A.T.

### PAYMENT

Payment terms must be strictly respected starting from the invoice date. Payments should be made directly to Hidra Ceramica Srl at its headquarter. Any delay caused by the Purchaser or should any dispute arise between the parties as to the guarantees granted will not result in an extension or change of the terms of payment agreed upon and any Purchaser's action and exception will not be considered as prosecutable if the Purchaser does not prove to be up-to-date with his payments. In case of delay in any payment the supplies under way may be interrupted or cancelled. If no payments has been received within the terms set up in the invoice, Hidra Ceramica Srl will be authorized to issue a sight draft for the total amount of its credit plus the relevant expenses. Any possible delay in the payment will result in the charge of interest at the market current rate plus 2%. In case of failure to meet one of the payment dates the seller will be entitled to demand immediate payment of all other invoices. Payment of all the invoices may also be demanded if the seller receives information about others circumstances which may indicate that the purchaser's financial situation is not sound (for example: issue of bouncing cheques, protested bills of exchange, attached proceeding).

### DELIVERY TERMS, DELAYS OR OBSTACLES IN SUPPLY

When a delivery terms is stated, such term is given only for information purpose and is not binding since it is subject to any kind of contingency. Delivery is considered as being completed when the goods are available at our factory in Civita Castellana (Italy). Work stoppage resulting from act of God will exempt Hidra Ceramica Srl from the observance of the delivery term stated without giving the Purchaser the right to claim for any kind of damages. The goods shall always be collected and shall not remain in stock for any reason. Any stock or storage expenses or other costs will be charged to the Customer.

### CARRIAGE

Except for particular condition, goods are delivered ex factory and travel at Purchaser's risk even when they are delivered free port of destination. Partial supplies and early supply are permitted. The cost of transport is at Customer charge. Shipment are made on behalf of the buyer. In case of damages, breakages and shortages, the buyer has to notify to our firm through the carrier at the moment of the delivery. The supplier is the owner of the delivered goods up to the due payment. Terms of delivery are subject to variations and depending to the possibilities of the moment. Our firm is not responsible for any delay or missing deliveries caused by any facts independent of our will and any claim for reimbursement for any delay that may occur in delivery will not be accepted.

### PACKAGING

The packaging is made in pallets and shrink. The cost of the packaging is charged to the Purchaser, unless otherwise agreed upon as specified in the order confirmation. We charge of 3% for freights of packaging.

### LIABILITY

If the material is defective due to manufacturing defects recognized by technical assessments, Hidra reserves the right to replace or to credit the value in the time required by law. In no event shall the liability can extend to any direct or indirect which might arise also from the installation of the defective material. It is burden of the buyer to check every item as soon as received, and so in particular to open the packaging and boxes of containment; the period of revocation of law for defects apparent begins at the time of delivery thereof.

### COMPLAINS

No complain of any kind will be accepted after eight days from the receipt of the goods. Possible complains should be made through a registered letter within such term. In any case no objection will be accepted for already installed material.

### TECHNICAL FEATURES AND COLORS

Hidra Ceramica Srl reserves the right to change the features of its products in order to improve them from the technical and aesthetic viewpoint or to interrupt the production of certain models in any time without notice. Weight and measures are given only for information purposes. Discrepancies may be found between the dimensions shown in the catalogues and the real pieces because of the manufacturing characteristics of the articles in ceramic.

### COMPETENT COURT

Any dispute between Hidra Ceramica Srl and the Purchaser will be settled only by the Court of Viterbo (Italy), with no exception to such rule, even in case of summons for guarantee, consolidation of actions or lawsuit contingency



COLORI DISPONIBILI  
AVAILABLE COLORS

# MATT

---

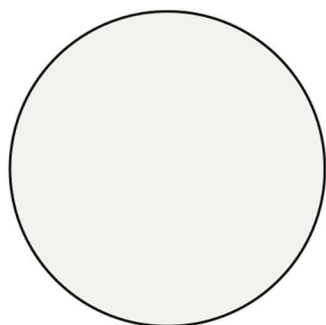

006

Bianco matt  
*White matt*

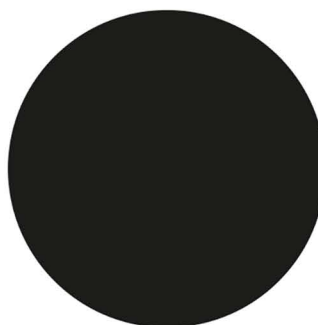

026

Nero matt  
*Black matt*

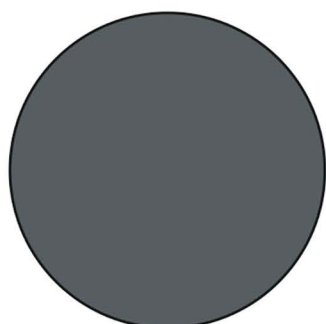

053

Grigio matt  
*Grey matt*

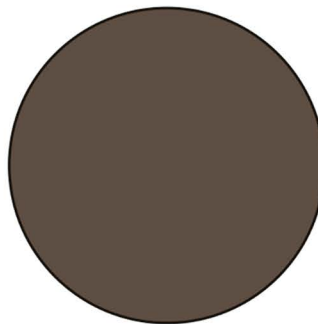

096

Marrone matt  
*Brown matt*

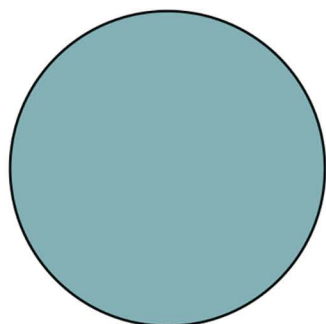

052

Verde matt  
*Green matt*

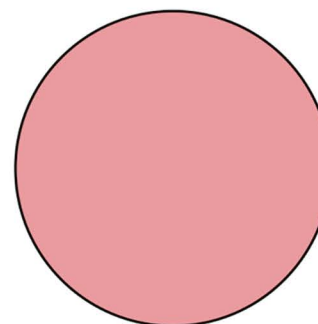

097

Rosa matt  
*Pink matt*

COLORI DISPONIBILI  
AVAILABLE COLORS

# LUCIDI

---

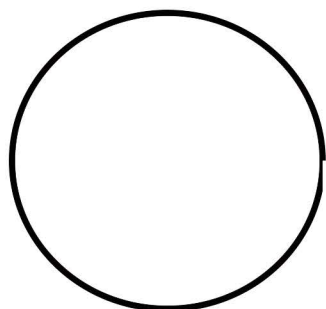

**01 Shine white**

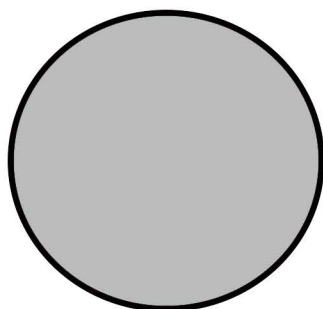

**108 Shine grey**

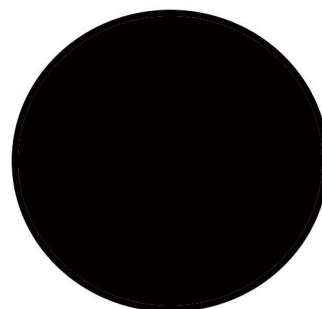

**09 Shine black**

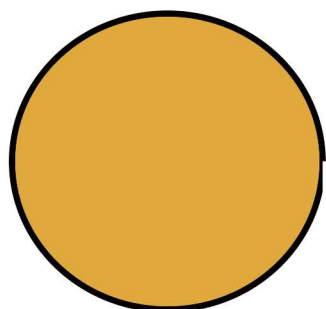

**109 Shine yellow**

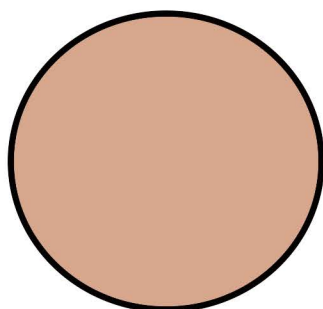

**116 Shine pink**

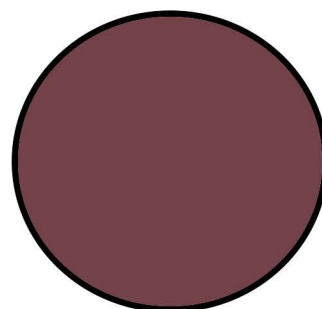

**105 Shine red**

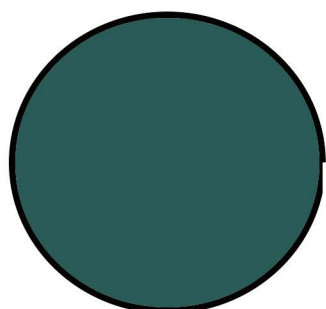

**106 Shine green**

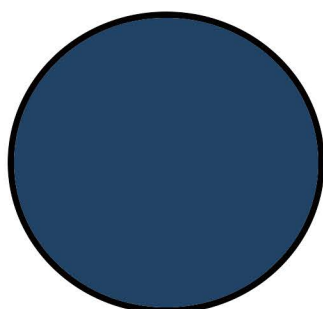

**107 Shine blue**

**FINITURE DISPONIBILI**  
*FINISHES DECORATIONS*

---

**DECORO /decor**



**MARMO / marble**

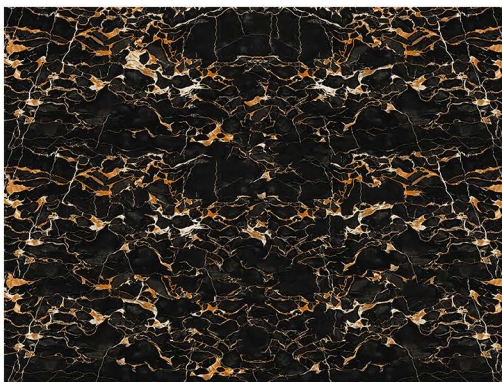

**LEGNO / wood**





**Art director**

– Leonardi&Partners

**Graphic design**

– Leonardi&Partners

**Immagini**

– Leonfoto.it

**Stampa**

– Arti Grafiche Celori

**HIDRA Ceramica S.r.l**

Via Rio Maggiore snc  
01033 Civita Castellana (VT) Italy

Tel. (+39) 0761 518181

Mail. [info@hidra.it](mailto:info@hidra.it)

[www.hidra.it](http://www.hidra.it)

